

Appendix 15: Integrated Transport Assessment Report

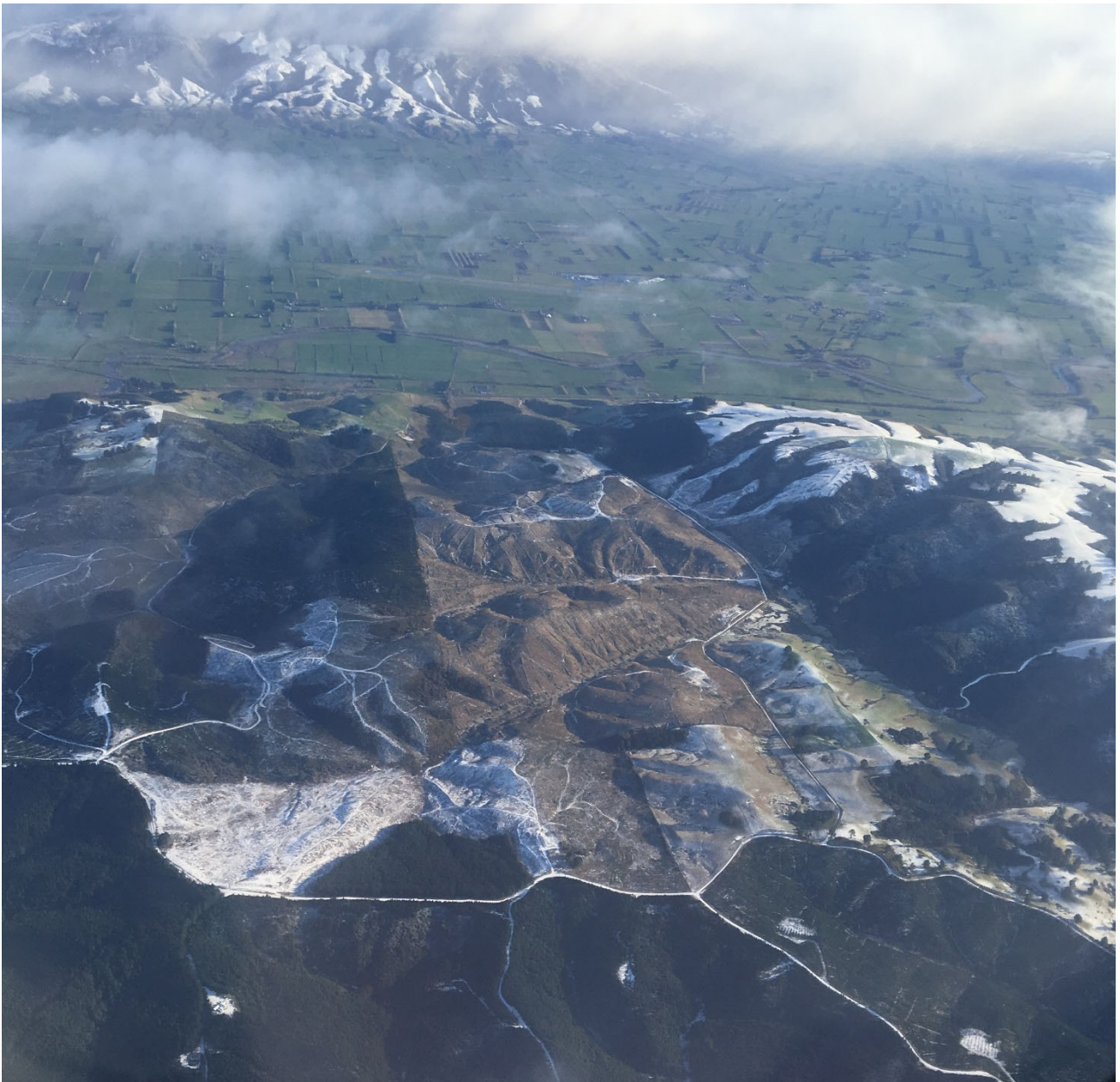

Dunedin City Council

Waste Futures - Smooth Hill Landfill
Integrated Transport Assessment



(August 2020 ([updated May 2021](#)))

Table of contents

1.	Introduction	1
1.1	Purpose.....	1
1.2	Project Overview.....	2
1.3	Purpose of this Report	3
1.4	Assumptions	3
2.	Baseline Environment	4
2.1	Site Location	4
2.2	Road Network	5
2.3	Existing Traffic Volumes	9
2.4	Future Baseline Traffic Demand	10
3.	Proposed Landfill Development	11
3.1	Site Establishment and Construction Activity	11
3.2	Operational Activity	11
3.3	Public Road Upgrades	12
3.4	Hazardous Activities and Industrial List (HAIL)	14
3.5	Internal Access Roads and Perimeter Road	14
4.	Assessment of Effects.....	15
4.1	Construction (Temporary) Effects.....	15
4.2	Operational Effects	16
5.	Recommendations	19
5.1	State Highway 1 Intersection	19
6.	Conclusion	20
7.	Limitations	21
8.	References.....	22

Table index

Table 1 Forecasted AADT	10
Table 2 Projected heavy vehicle movements for waste disposal to proposed Smooth Hill Landfill (Updated May 2021).....	17

Figure index

Figure 1 Proposed Smooth Hill landfill location (Updated May 2021).....	4
Figure 2 Proposed Smooth Hill landfill general locality features (Updated May 2021).....	5
Figure 3 Intersection of SH1 and McLaren Gully Road.....	6
Figure 4 SH1/McLaren Gully Road (including close-up) 10-year collision data (2009-2019).....	8
Figure 5 Existing traffic turning movements (7 am – 8 am) for the intersection of SH1 / McLaren Gully Road (2019).....	9
Figure 6 Telemetry Site 27, Milton (2018) – Average Weekday Hourly Traffic.....	10
Figure 7 Estimated traffic turning movements (7 am - 8 am) for the intersection of SH1/ McLaren Gully Road (2050).....	18

1. Introduction

1.1 Purpose

The Dunedin City Council (Council) collects residential waste and manages the disposal of both residential and [most](#) commercial waste [generated from](#) the Dunedin City area and environs.

The Council has embarked on the Waste Futures Project to develop an improved comprehensive waste management and diverted material system for Dunedin, including future kerbside collection and waste disposal options. As part of the project, the Council has confirmed the need to develop a new landfill to replace the Council's current Green Island Landfill which is [envisaged to reach full capacity in the next few years. Final closure could be around 2028 depending on the closure strategy adopted by the Council. likely to come to the end of its functional life sometime between 2023 and 2028.](#)

The Council commenced [siting studies](#) for a new landfill location in the late 1980's and early 1990's and selected the Smooth Hill site in southwest Dunedin as the preferred [location](#). At that time the site was designated in the Dunedin District Plan, signalling and enabling its future use as a landfill site. The [Council also secured an agreement with the then landowner, Fulton Hogan Ltd, to purchase the land and the Council took ownership of the land in September 2020. Since the 1990's the Council extended the life of Green Island Landfill and further development of the Smooth Hill site has been on hold](#)~~Council also secured an agreement with the current landowner, Fulton Hogan Ltd, to purchase the land.~~

~~Over the following period the Council extended the life of Green Island Landfill and further development of the Smooth Hill site has been on hold~~As part of the Waste Future's Project, the Council has reconfirmed the technical suitability of Smooth Hill for the disposal of waste and has developed a concept design for the landfill and associated road upgrades. The concept design for the landfill has been developed by GHD with technical input from Boffa Miskell and represents contemporary good practice landfill design that meets adopted New Zealand landfill design standards. The Council is now applying for the remaining RMA authorisations required to enable the construction, operation, and aftercare of the landfill, and construction of the associated roading upgrades.

[The Council lodged applications for resource consents for Smooth Hill landfill with both the Otago Regional Council and Dunedin City Council in August 2020. The applications included an earlier version of this report.](#)

[This report has now been revised in May 2021 to reflect both the changes in the design and in response to s92 questions. While being similar in many ways to the previous design, the key changes to the design are summarised as follows:](#)

- [The landfill size has been reduced. The revised landfill lies within the footprint of Stage 1 and Stage 2 of the original design, with the western Stages 3, 4 and 5 no longer included \(for comparison see Drawings C102 and C104\). In overall terms:](#)
 - [the footprint of the landfill is reduced from 44.5 ha to 18.6 ha](#)
 - [landfill \(gross\) capacity is reduced from approximately 7.9-million m³ to 3.3-million m³](#)
 - [net waste capacity is reduced from 6.2-million m³ to 2.9-million m³](#)
 - [the predicted landfill life has reduced from 55-years to 40-years](#)
- [Practical adjustments to the general construction of the landfill, including:](#)

- Landfill staging and construction sequencing, to a more typical 'bottom-up' filling methodology, which improves the intermediate and overall landform stability of the new design (Drawing C210 to C214)
- Leachate containment and collection systems adjusted to reflect the revised construction sequencing
- Construction phase systems for stormwater diversion, treatment and control
- Relocation of the attenuation basin to the west of the revised landfill footprint rather than immediately downstream of the landfill toe.

1.2 Project Overview

The proposal includes the following key components:

- ~~The staged construction, operation, and closure of a class 1 landfill within the existing designated site to accept municipal solid waste. The landfill will have a capacity of approximately 6 million cubic metres (equivalent to 5 million tonnes) and expected life at current Dunedin disposal rates of approximately 55 years.~~ The landfill will receive waste only from commercial waste companies or bulk loads.
- Infrastructure to safely contain, collect, manage, and dispose of leachate, landfill gas, groundwater, and stormwater so as to avoid consequential adverse effects on the receiving environment.
- Facilities supporting the operation of the landfill, including staff and maintenance facilities.
- Environmental monitoring systems.
- Landscape and ecological mitigation, including planting.
- Upgrades to McLaren Gully Road (including its intersection with State Highway 1) and Big Stone Road, to facilitate vehicle access to the site.

The proposed Smooth Hill Landfill site is located approximately 28 km southwest of Dunedin City. The boundary of the proposed site is shown in Figure 1. The waste facility itself will operate within these boundaries.

4.21.3 Purpose of this Report

The project will result in an increase in vehicle trips using the SH1 and McLaren Gully Road intersection as well as McLaren Gully Road and Big Stone Road to the proposed site entrance on Big Stone Road (see Drawing C102). GHD has completed an assessment of the transport related impacts of the landfill. In doing so, this Integrated Transport Assessment (ITA) includes consideration of the following key matters:

- Details of the existing road network
- An overview of the transport related components of the proposal
- The level of additional vehicular traffic anticipated to be generated by the landfill and the associated effects on the performance and safety of the receiving road network
- The design of the intersection of SH1 and McLaren Gully Road to accommodate the increase in heavy vehicle movements
- A summary of the McLaren Gully Road/Big Stone Road upgrade design criteria

This report considers the transportation effects of the Smooth Hill during both the construction and the operational phases, as well giving due consideration to the long-term future scenario. By way of summary, it is anticipated that the transportation effects of the Smooth Hill landfill can be suitably managed with less than minor adverse effects on the surrounding transport environment.

This report should be read alongside the Landfill Concept Design Report (GHD, 2021a⁹) and the Design Drawings.

4.31.4 Assumptions

As discussed in the Design Report (GHD, 2021a), the landfill will be developed as a Class 1 landfill and will only receive waste from commercial waste companies. The Council's waste reduction objectives and policies propose that the waste stream will diminish over the life span of the landfill. However, population growth is likely to add to the waste stream over time. Therefore, the assumption has been made that the current average waste stream from the Council of 690,000 tonnes per year (and associated traffic generation) will be maintained for the life of the landfill.

2. Baseline Environment

2.1 Site Location

The site is located approximately 28 km south-west of central Dunedin in the hills between the Taieri Plain and the east coast. The site is bounded to the north and west by forestry land, and to the north-east by pastoral farmland. The strategic location of the site is presented in Figure 1 and Figure 2.

Figure 1 Proposed Smooth Hill landfill location (Updated May 2021)

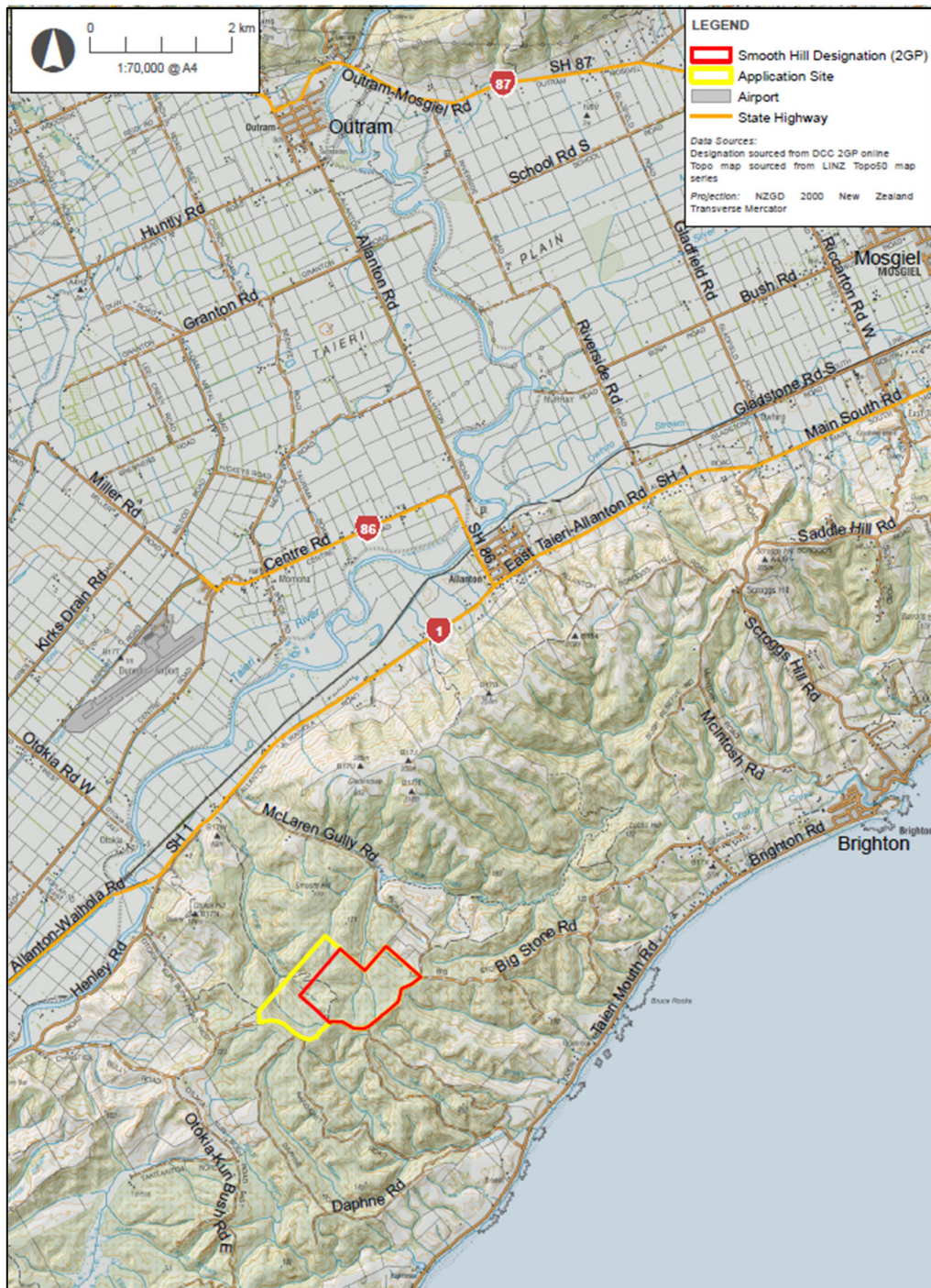
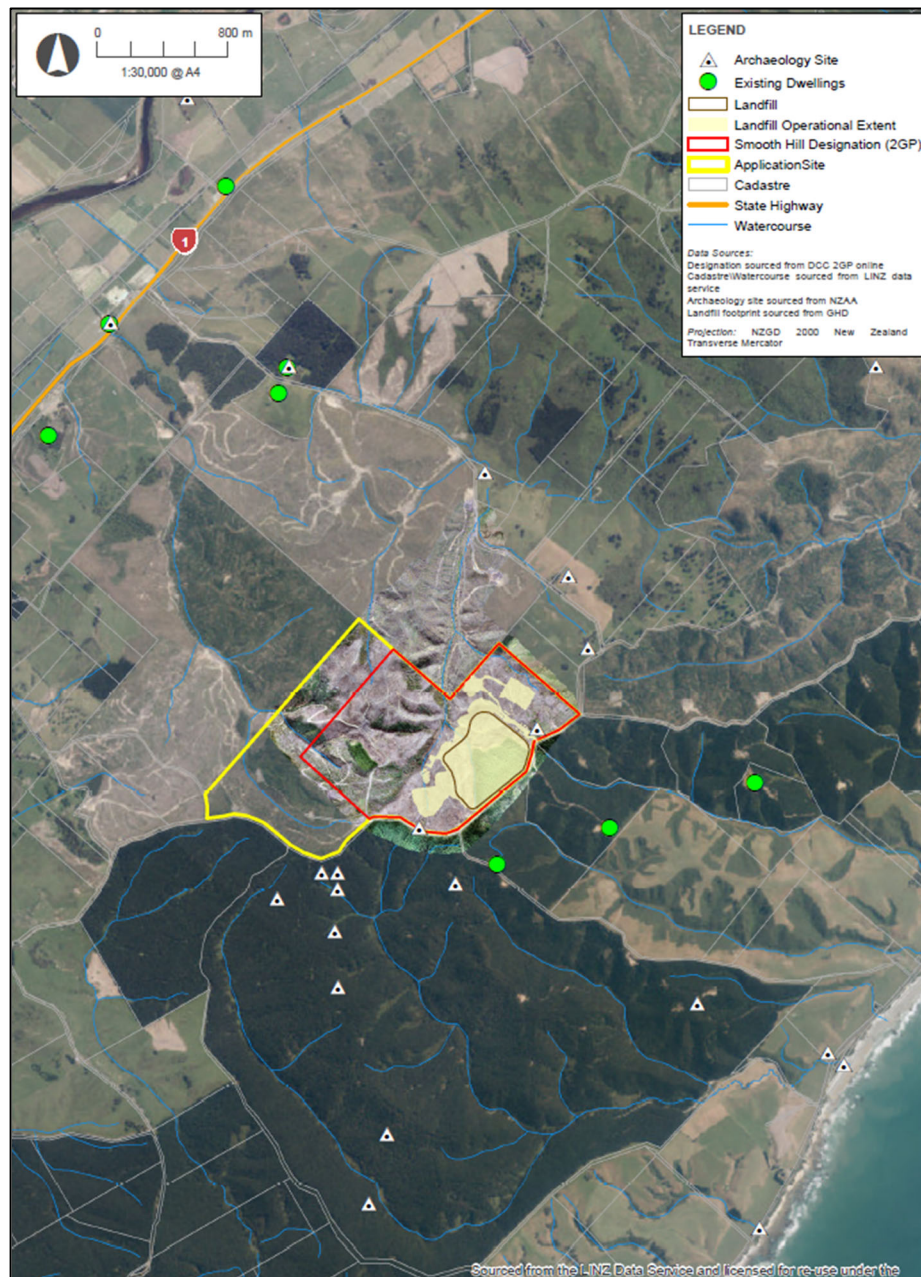

Figure 2 Proposed Smooth Hill landfill general locality features (Updated May 2021)



Access to the site is off State Highway 1 (SH1), approximately 4.5 km south of Allanton, via two rural roads: McLaren Gully Road and Big Stone Road. Within the site, current access is via a series of forestry roads and tracks. The site has been logged and re-planted in the past 75 years ~~with although a large stand of *Macrocarpa* remain in the south-east part of the site and~~ areas of remnant native vegetation occur in the gully bottoms.

2.2 Road Network

2.2.1 State Highway 1

SH1 is the key national transport route and is the main link between Dunedin and Southland. In the vicinity of the site, SH1 is known as Allanton-Waihola Road. The road is formed as a sealed two-lane carriageway with edge lines and a white dashed centre line. Allanton-Waihola Road has a typically straight and flat alignment, operating under the default open road speed limit of

100 km/h. MegaMaps (2019) report the current mean operating speeds being between 90 – 94 km/h.

2.2.2 McLaren Gully Road

McLaren Gully Road is a low volume rural road providing access to a small number of residential properties (see Figure 2), as well as commercial forestry sites. The road is unsealed. Access to McLaren Gully Road is via a priority T intersection with SH1 formed with a basic treatment as presented in Figure 3.

Figure 3 Intersection of SH1 and McLaren Gully Road

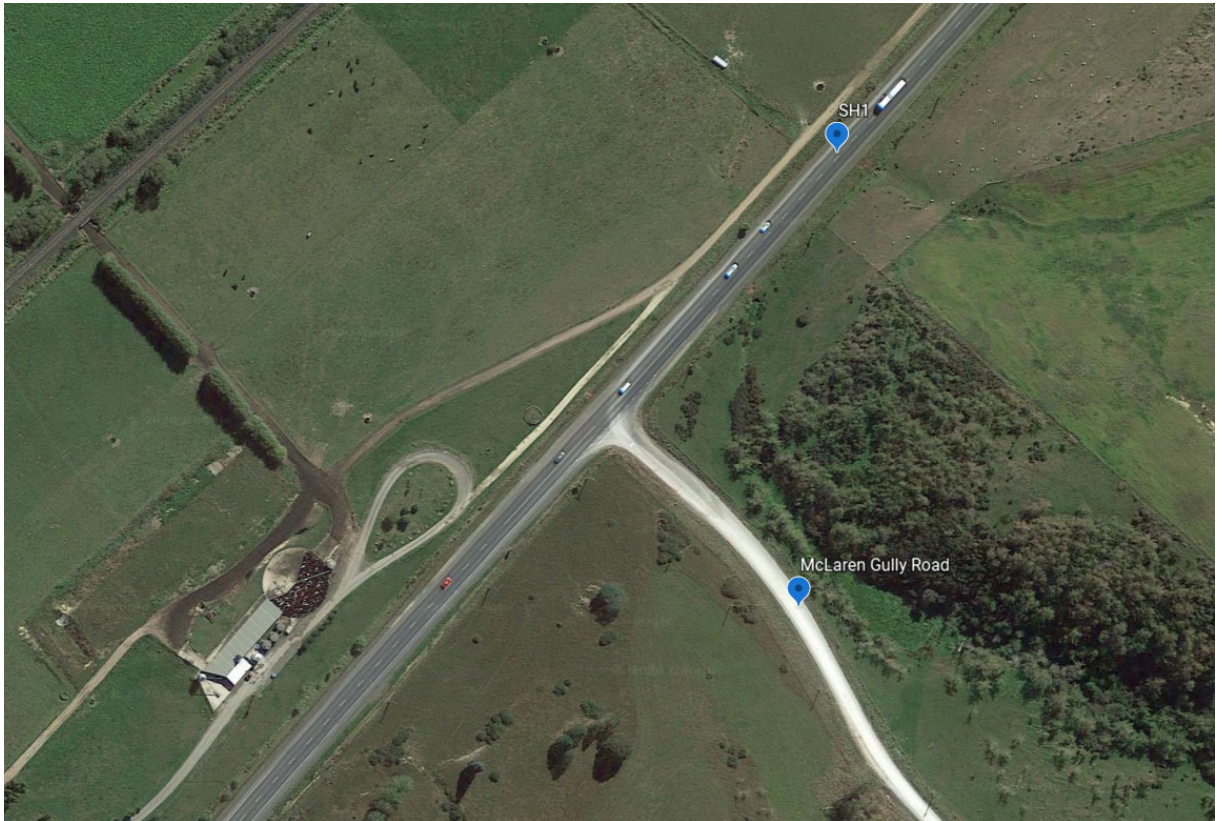

2.2.3 Big Stone Road

Big Stone Road is a low volume rural road and is unsealed. The proposed site has direct frontage to Big Stone Road and site access is located approximately 400 m from the McLaren Gully/Big Stone Road junction (Drawing C102). Two existing residential driveways access Big Stone Road in the vicinity of the proposed landfill site (see Figure 2) and the road is used for commercial forestry activity.

2.2.4 Active Modes

There are no explicit provisions for walking or cycling on the surrounding roads. McLaren Gully Road and Big Stone Road are predominantly used by logging trucks, and therefore, walking and cycling on these rural roads is not encouraged. On the state highway, cyclists are able to use the roadside shoulder; walkers are highly unlikely due to the remoteness of the area.

2.2.5 Crash History

The 10-year reported crash data was extracted from the Transport Agency's Crash Analysis System (CAS) for the intersection of SH1 and McLaren Gully Road and 750 m north and 750 m south of the intersection on SH1. Between 2009 and 2018, as well as the crash data available

for 2019 (up to July 2019), 19 crashes were reported in the study area (data is shown on Figure 4 and the Figure 4 close up). In summary:

- No crashes at the junction of McLaren Gully Road and SH1
- On McLaren Gully Road:
 - A minor injury crash April 2010 approx. 250 m from SH1 – driver lost control travelling towards SH1 (Yellow “M” on Figure 4)
 - A non-injury crash March 2010 approx. 950 m from SH1 – driver lost control travelling towards SH1 (Green “N” on Figure 4)
- On SH1:
 - A non-injury crash January 2016 just to the north of the McLaren Gully Road junction (Green “N” on Figure 4 close up)
 - A non-injury crash September 2013 just to the south of the McLaren Gully Road junction (Green “N” on Figure 4 close up)
 - A minor injury crash March 2018 just to the south of the McLaren Gully Road junction (Yellow “M” on Figure 4 close up)
 - Fourteen other crashes on SH1 as shown on Figure 4 – three of which resulted in serious injury near the junction with Henley Road and SH1.

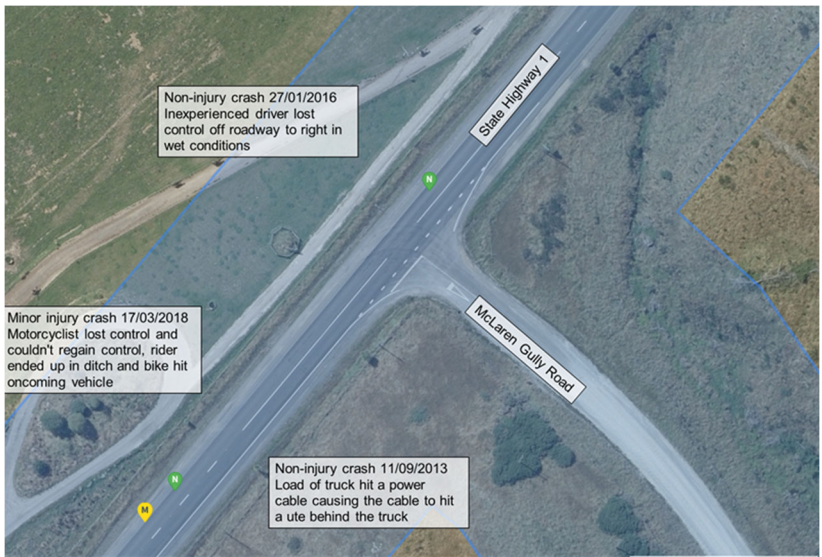

Figure 4 SH1/McLaren Gully Road (including close-up) 10-year collision data (2009-2019)¹

- Green “N’s” = Non-Injury Crashes
- Yellow “M’s” or yellow quadrants in map circles = Minor Injury Crashes
- Orange quadrants in map circles = Serious Injury Crashes

¹ Extracted from NZTA CAS database

2.3 Existing Traffic Volumes

2.3.1 Turning Count Survey (2019)

A traffic survey count was undertaken at the intersection of SH1 and McLaren Gully Road on Wednesday 29 May 2019 between 6 am and 8 am. The hour between 7 am and 8 am is representative of the morning peak for the proposed development, when taking into consideration the estimated future peak arrival and departure of trucks to the site. Figure 5 shows the counted turning movements at the intersection. The data is considered to represent the morning peak of a typical working day in the winter season. There was overnight rain, with no rain during the course of the survey.

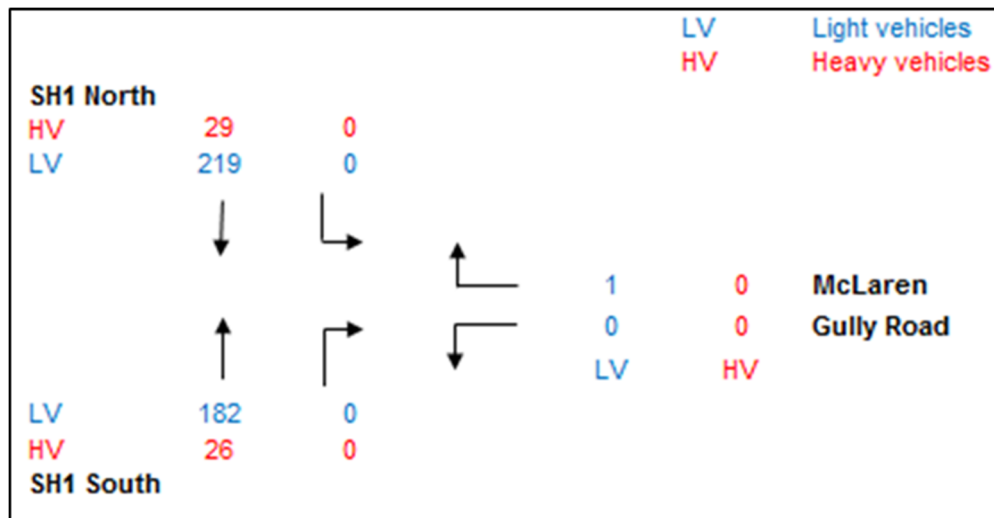

Figure 5 Existing traffic turning movements (7 am – 8 am) for the intersection of SH1 / McLaren Gully Road (2019)

Across the two-hour traffic count, the surveyor reported four overtaking manoeuvres along SH1, adjacent to the McLaren Gully Road intersection.

2.3.2 Telemetry Site 27

Approximately 30 km south of the site on SH1 there is a National Telemetry site (Milton – Telemetry Site 27). The Annual Average Daily Traffic (AADT) has been recorded at this location since the 1970s as part of the Transport Agency's (formerly known as Transit NZ) long term strategy plan for monitoring of state highways across the country.

The average weekday hourly traffic recorded at the telemetry site is shown in Figure 6. This indicates that the average weekday traffic (all vehicles) rises steadily across the morning period, remains consistent during the middle of the day, and rises to a peak between 5 pm and 6 pm. Note that this data includes Mondays and Fridays.

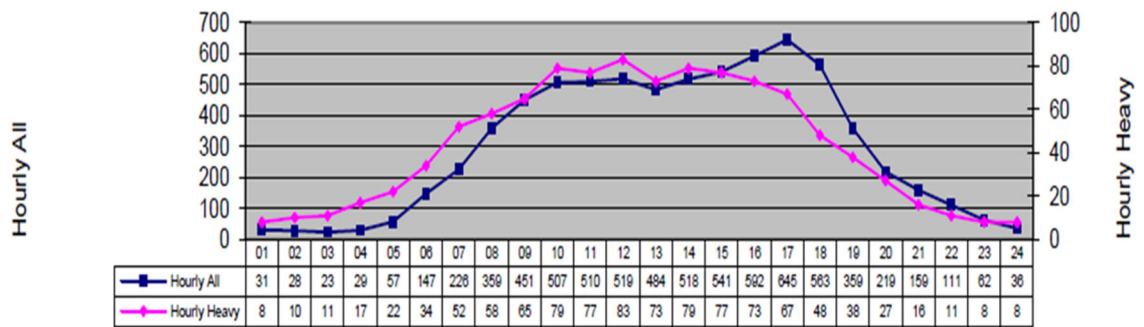

Figure 6 Telemetry Site 27, Milton (2018) – Average Weekday Hourly Traffic²

It should be noted that the average weekday traffic between 7 am and 8 am is 226 vehicles (total two-way) for the telemetry site in 2018. This is significantly less than the manual survey on 29 May 2019 (457 vehicles – total two-way), adjacent to the site. This suggests that volumes further north, adjacent to the site, are more significant than at the telemetry site. Therefore, while the telemetry data has been used to calculate a growth factor (an appropriate approach), the manual survey data has been used to establish the base 2019 traffic flow at the site.

2.4 Future Baseline Traffic Demand

Using the telemetry data, the projected AADT has been calculated for future years and is presented in Table 1.

Table 1 Forecasted AADT

Future Year	AADT (two-way) Forecasted
Current (2018)	7,206
2030	8,360
2035	8,898
2040	9,436
2045	9,973
2050	10,511

Long term growth to 2045/2050 is around 1.7% compound growth. For 2030, it is around 2.0% compound growth.

The compound growth rate is calculated by the following formula:

$$\text{Compound growth (\%)} = \frac{\text{Ending Value}}{\text{Beginning Value}}^{\frac{1}{\text{No. of years}}} - 1$$

² Source: <https://www.nzta.govt.nz/assets/resources/state-highway-traffic-volumes/docs/2009-2018-national-telemetry-site-profiles.pdf>

3. Proposed Landfill Development

The project proposal is described in detail in the Landfill Design Report (GHD, 2021a9), with the transportation aspects of the project focusing on:

- Activities relating to site establishment and construction of the landfill
- Day-to-day operation of the landfill

3.1 Site Establishment and Construction Activity

Initial construction activities occur prior to the landfill accepting its first waste. It is anticipated that these activities will take place over at least two construction seasons prior to the landfill accepting waste, with a construction season generally being defined as the period from October one year to April/May the following year.

Initial construction activities will include:

- SH1 junction and McLaren Gully Road/Big Stone Road upgrades
- A site entrance from Big Stone Road and security fencing
- Construction of main offices, associated facilities, and leachate storage tanks and load out
- Construction of attenuation basin and toe berm
- Construction of permanent stormwater controls around the initial stage of landfill development
- Construction of sediment control measures
- Formation of base grades for sub stage of Stage 1 of landfill, low permeability liner system and leachate collection system
- Perimeter screening plantings
- The landfill gas system will not be installed until 200,000 tonnes of waste is placed in the landfill. This is expected to be around [3 to 42](#) years after commencement of the landfilling.

3.2 Operational Activity

The landfill will be open for waste deliveries seven days per week and up to 9.5 hours a day. The proposed opening hours are as follows:

- Monday to Saturday 8.00 am – 5.30 pm
- Sunday 9.00 am – 5.30 pm
- Closed Christmas Day, [New Year's Day](#), Easter Friday, and Anzac Day until 1 pm

The landfill operator may commence operations 1 hour before and up to 1.5 hours after the opening hours to prepare for waste delivery in the morning and to close off the works at the end of the day. Staff or contractors may be on-site outside these hours for required work, monitoring or maintenance.

Anticipated truck numbers to access the site include the following during operational phases:

- Commercial deliveries
- Delivery of waste and possibly clean fill type materials for daily cover or similar

- Leachate transport (initial phase of operation only)
- Water deliveries (during initial phase of operation)
- During periods of construction vehicle numbers will increase due to construction materials deliveries and additional site workers

For delivery of waste, the expected waste flow is 690,000 tonnes per annum. The estimated number of truck movements has been calculated and presented in Section 4.2.1 of this report (Trip Generation). This data indicates an average number of truck movements per day in the order of 104. This is an average number and allowing for daily variations during the year and the need to truck leachate off site/water deliveries for at least the first few years truck movement could be up to approximately 25 per day.

For clarity, the site will only receive deliveries from commercial operators – general public access will be excluded.

This does not include light vehicles/cars for workers and similar. Light vehicle movements may be up to a further 25 per day.

Trucks arriving at site will access the landfill through the proposed primary access route via McLaren Gully Road and Big Stone Road. The site will be fenced and a main gate at the access point will provide security. Trucks will pass through the gate and be weighed at a weighbridge located 200 m inside the gate. If for any reason a truck is rejected, a turning area is provided for the vehicle to leave the site. Following weighing, the truck will progress to the active landfill operational area for discharge via the internal access roads through the facilities area and across the landfill toe embankment. Once emptied to the landfill, trucks will pass through the wheel wash to ensure any tracked waste is removed before departing from the site via the weighbridge and main gate.

3.3 Public Road Upgrades

The proposed upgrades to McLaren Gully Road and Big Stone Road as far as the site entrance are shown on Drawings C601 through C612.

The roads in their current arrangement have substandard geometry, particularly width and visibility, to safely accommodate two way traffic. These issues will be exacerbated with the increased traffic demands arising from the routine operation of the landfill including increased usage by heavy commercial vehicles. To ensure there are no adverse effects proposed works to address these issues include widening, grading and sealing of the road to the site entrance.

The upgrades are based on the following primary design parameters and are generally in accordance with Dunedin City Council's *Code of Subdivision and Development 2010*:

- Vertical gradients limited to 10%
- Cross-fall – typical 3%, with a maximum of 8% superelevation around curves where necessary
- Lane width – 3.5 m x 2 sealed lanes, with widening to accommodate design vehicle swept path in accordance with Austroads Part 3
- Shoulder width – 0.25 m sealed plus 0.25 m unsealed
- Shoulders being swales with a 5H:1V road side slope, 1 m base and 4H:1V boundary side slope
- Cut face slope to be 1H:4V beyond swale, based on observed cut faces and desktop review of geotechnical conditions
- Embankments slopes at 30 degrees

- Design vehicle – HMPV truck (equivalent to B Double)

The design presented on Drawings C601 to C612 has undergone several iterations. Since the August 2020 version of this report additional survey data for the road and adjacent properties has been collected to assist in development of a more detailed preliminary design. In addition, the Council have requested GHD to investigate if the design can avoid to the extent practicable wetlands identified along the margins of McLaren Gully and Big Stone Road (wetlands are shown on Drawings C601 to C612). The revised design presented on the drawings has largely achieved this request with minimal residual impact on existing wetlands (less than 10 m² of wetlands are impacted compared to earlier designs which impacted 0.53 ha hectares of wetlands). Further information on existing wetlands and anticipated effects is provided in the Ecology Report (Boffa 2020)

Drawings C601 to C612 show the following information:

- Extent of existing mapped wetlands
- Road reserve and property boundaries
- Road design centre line
- Road edge and swales
- Where required, boundary extent of proposed earthworks for areas of cut and fill
- Swales are shown draining to wetlands

The design presented in Drawings C601 to C612 is preliminary and will be developed further during detail design in accordance with the DCC Code of Subdivision and Development 2010. However, any future adjustments are likely to be relatively minor as the revised design is based on detailed survey data collected for both the road corridor and the adjacent properties.

The design anticipates the following earthworks:

- Total cut volume up to 46,700 m³
- Total fill volumes up to 18,470 m³
- Cut slopes generally up to 4 m high with limited sections with higher cut slopes:
 - CH2820 - CH3020 (200 m) cut slopes typically 5 to 6 but ~ 7 m for 30 m
 - CH2380 - CH2540 (160 m) cut slopes typically 5 to 6 m but ~7 m for 30 m
- Embankments up to 7.5 m high
 - CH1300 - CH1380 (80 m) retaining structure up to 2.5 m high at toe of embankment
- Where wetlands are located close to the road corridor the road swales have been removed from the design and road stormwater will drain directly to the wetlands. In some of these sections that design has included a small retaining wall/slope along the road corridor margin to ensure earthworks are excluded from the wetlands. Typically these are relatively small (less than 0.5 m high). In one section (CH2940 to CH3020) the retaining wall/slope varies from 0.5 to 1.4 m high.

The adjustment of the road design to avoid wetlands has resulted in an increase in the size of some of the cuttings, as outlined above. Loess road cuttings are typically cut at a steep angle to minimize erosion.

The road design anticipates surplus material in the order of 28,000 m³. Construction and operation of the landfill requires materials for: daily/intermediate cover; liner and capping; and bulk earthworks. The surplus materials will be suitable for at least one of these purposes and will be stored at one of the landfill stockpile locations (see Drawing C201) for future use.

[Anticipated sediment, stormwater and dust management controls are described in the Surface Water Report \(GHD, 2021b\)](#)

3.4 Hazardous Activities and Industrial List (HAIL)

[The findings of a Hazardous Activities and Industries List \(HAIL\) activities investigation are summarized in the Preliminary Site Investigation Report \(GHD, 2021c\). The study did not find any HAIL activities associated with the landfill site or proposed road upgrades. As HAIL activities have not been identified, the National Environmental Standard for Assessing and Managing Contaminants in Soil to Protect Human Health\) Regulations 2011³ \(NES CS\) does not apply to the works associated with development of the landfill site and a consent is not required under the NESCS](#)

3.43.5 Internal Access Roads and Perimeter Road

An access track will be constructed around the final landfill perimeter next to the perimeter swale drain. The purpose of the track is to provide 4-wheel drive access to the perimeter of the landfill for monitoring and maintenance purposes. The track will be a gravel road.

The perimeter track will be progressively constructed along with the perimeter swale drain as the landfill stages are developed. Stormwater from the perimeter access will be directed to the swale drain.

As discussed earlier in this report, waste delivery and construction traffic will enter the landfill via the main gate. The administration block and the leachate storage facilities are located approximately 300 m to 400 m inside the main gate. The waste delivery trucks will continue straight on a downhill grade to the landfill toe embankment. Site traffic for other on site facilities and the [Land Fill Gas \(LFG\)](#) plant will turn left to the lower facilities platform.

All internal access roads will be unsealed beyond the wheel wash.

Temporary aggregate access roads will be constructed on the landfill to provide passage of the waste delivery trucks. These temporary access roads will be amended regularly as the waste is placed and the level of the waste increased as the cell is progressively filled.

³ [Resource Management National Environmental Standard for Assessing and Managing Contaminants in Soil to Protect Human Health, 2011](#)

4. Assessment of Effects

4.1 Construction (Temporary) Effects

4.1.1 Trip Generation

Initial construction activities occur prior to the landfill accepting its first waste. It is anticipated that these activities will take place over at least two construction seasons prior to the landfill accepting waste, with a construction season generally being defined as the period from October one year to April/May the following year.

The landfill will be developed in stages, with one stage being filled with waste while the next stage is constructed. Construction phases will be recurring every two to five years during the life of the landfill and are likely to require the following equipment:

- Vegetation chipper x 1
- Excavators x 4 (20 to 30 tonne)
- Scrapers x 2
- Moxy x 1
- Bulldozers (D6 equiv) x 2
- Padfoot roller x 1
- Grader x 1
- Vibrating smooth drum roller x 2
- Water cart
- Delivery trucks (come and go – only 1 stationed on site)

In addition to heavy vehicles, there will be construction staff arriving in light vehicles to the site. Construction staff are likely to work typical work hours with most staff arriving during the morning peak and leaving during the evening peak.

4.1.2 Proposed Mitigation Measures for Construction Period

It is recommended that a Construction Traffic Management Plan (CTMP) is prepared to the satisfaction of the Transport Agency and the Council. The CTMP is to be prepared prior to the commencement of site establishment and construction activities. This is a standard practice required for all land development and major earthworks undertaken, with the CTMP to include details of:

- Construction dates and times of work
- Nature and frequency of activities and traffic movements
- Truck route diagrams between the landfill and the external road network
- Specific measures to be followed when delivering special loads, such as the excavators, to avoid peak periods on the state highway
- Temporary traffic management measures to manage the interactions of construction traffic and other road users in a safe manner – especially for the period of work to upgrade the intersection of SH1 and McLaren Gully Road
- Details of the site access/egress throughout the construction period, including any limitations on heavy vehicle movements

- Measures to eliminate or minimise the impact on existing users of McLaren Gully Road such as residents and other commercial activities

It is considered that a CTMP approved by [NZTA-Waka Kotahi NZ Transport Agency](#) and the Council will allow the site establishment and construction activities to be appropriately managed so that any generated traffic effects are acceptable.

4.2 Operational Effects

4.2.1 Trip Generation

The waste to be disposed to the Smooth Hill Landfill will be that diverted from the Green Island Landfill once it is closed, plus other potential regional waste streams. The following assumptions were made for the traffic assessment:

- The AM landfill traffic peak is assumed to be between 7 am to 8 am as traffic arrives ahead of site opening. For most landfills, the hour before the facility opens and then the first open hour are the busiest (i.e. 7 am - 9 am). This is based on general site experience as many waste delivery vehicles are filled the day before and discharge to the landfill when open the next morning.
- With background traffic on the road network generally being higher between 7 am - 8 am, this was designated as the morning peak period.
- The new landfill at Smooth Hill is expected to be in operation 7 days a week.
- The projected annual waste to be disposed at the site will be 690,000 tonnes for the duration of the site operation (assume to be at least 4030 years). This assumes no growth factor in waste volumes for future years while the landfill site is in operation and assumes no other significant waste streams or other material streams will be brought to the Smooth Hill site. Furthermore, the new landfill site will not include a waste transfer station meaning public and/or small commercial users are not permitted access to the landfill.
- Heavy truck movements will be 80% full. This is conservative, as in practice, most trucks will be operating between 90-100% capacity as the waste will be coming from the waste transfer stations or in bulk directly from commercial suppliers where pre-approval of disposal is required.
- The majority (90%) of the waste is expected to be picked up from waste transfer stations in Dunedin, north of the landfill site, with some (10%) from the regions around Dunedin. Therefore, it is assumed the majority of vehicles will therefore be turning left (90%) into McLaren Gully Road from SH1 and right out of McLaren Gully Road onto SH1, to return to Dunedin.
- Site management and operation staff on site are estimated to be between 6-10 personnel. They will travel by car to/from the site at the start/end of the day. This includes the following key personnel; weigh bridge operator, manager, compactor/bull dozer and excavator drivers and tip face attendant.
- Eight personnel are assumed to arrive by car in the morning peak time (7 am - 8 am).
- The landfill will experience an increase in trips during construction periods (lasting approximately three months) every 3 -10 years, for new cell construction. During these periods it is assumed that an additional 10 construction personnel will be driving to/from the site on a daily basis. As this is not a regular activity, it has not been accounted for within the modelling. Rather, it is expected that this activity will be managed through project specific traffic controls as described earlier in this report.

- In terms of when heavy vehicles are expected to arrive and leave the site in a working day, as discussed above, a significant proportion will arrive at the site in the morning with regular deliveries across the day. It was assumed that waste delivery trucks will spend approximately 30 minutes at the site per visit.
- As noted previously in this report, leachate will also be trucked off site for at least the initial few years of operation before changing to a pipeline.
- For the purposes of modelling in this report it has been assumed construction- initiates in 2021 (actual construction is likely to commence in the mid to late 2020's). The landfill is expected to have an operational life of approximately 4055 years. However, for the purpose of resource consents a 30-year period has been considered. Background traffic has therefore included a growth factor to 2050 to model a worst case scenario for the likely period of the consents.
- There are no significant confirmed new residential developments planned off SH1 to the south of this intersection or to the west of the landfill site along Big Stone Road. Therefore, the number of other users at SH1 and McLaren Gully Road intersection has not been increased over the operational life of the landfill.

Table 2 shows the projected number of heavy vehicle movements to the landfill site for a typical day. These numbers are based on the assumptions outlined above. The assumed mix of vehicle types shown on Table 2 is based on relevant experience for similar facilities elsewhere in New Zealand.

Table 2 Projected heavy vehicle movements for waste disposal to proposed Smooth Hill Landfill (Updated May 2021)

Heavy Vehicle Type	% Of total deliveries	Tonnes Capacity of each truck	Tonnes Total carted for all trucks @ 100% capacity)	No Trucks If 100% capacity	No trucks If 80% capacity	No Daily Trips If 80% capacity
6 Wheel Truck	10%	10	2,654	265	332	1
8 Wheel Truck	20%	15	7,964	530	664	2
Semi-trailer	30%	22	17,522	796	995	3
Truck & Trailer	40%	30	31,860	1,062	1,327	4
Totals			60,000	2,653	3,318	10

Table 2 shows that on average, 104 heavy vehicles are predicted to arrive and leave on any particular day (across the year). In practice, this total number of heavy vehicles may fluctuate across any given day due to seasonality or operational requirements and it has been assumed truck movements could be up to approximately 25 per day. This includes an allowance for leachate disposal trucks and water deliveries that will be required for the first few years of landfill operation plus other incidental heavy truck deliveries. The Design Report (GHD, 2021a) calculates that up to 4 daily leachate truck transports (assuming a 20 m³ truck) will be required during the first ~~ninesix~~ years of landfill operation and approximately up to 3 daily water truck deliveries. It is assumed that around ~~ninesix~~ years after operation leachate removal and water supply will switch to dedicated pipelines.

Not all of these vehicles will arrive and depart in the AM peak. Based on general landfill experience, it is expected at most 10 heavy vehicles will arrive in the AM peak (7 am – 9 am) with an assumed six departing within this time. This is considered a high and conservative estimate as it assumes one heavy vehicle arriving every 6 minutes. Other vehicles will then arrive and depart across the balance of the day.

With consideration of the existing use of McLaren Gully Road and the current traffic volumes on SH1 (approximately 7,400 vehicles per day with 12% heavy vehicles⁴), an increase of up to 25 heavy vehicles trips a day to and from the landfill site will have no noticeable effect on the operation of the receiving road environment. It is not anticipated that the increase in traffic volumes will impact the ability of residents on McLaren Gully Road or Big Stone Road to access driveways. The SH1/Maclaren Gully Road intersection performance is considered separately below.

4.2.2 Intersection Performance

Figure 7 shows the estimated traffic flows at the intersection of SH1/McLaren Gully Road in 2050 during the 7 am to 9 am period. These flows are based on the estimate of 10 heavy vehicles and 8 light vehicles arriving in the AM peak as landfill traffic and 6 heavy vehicles departing.

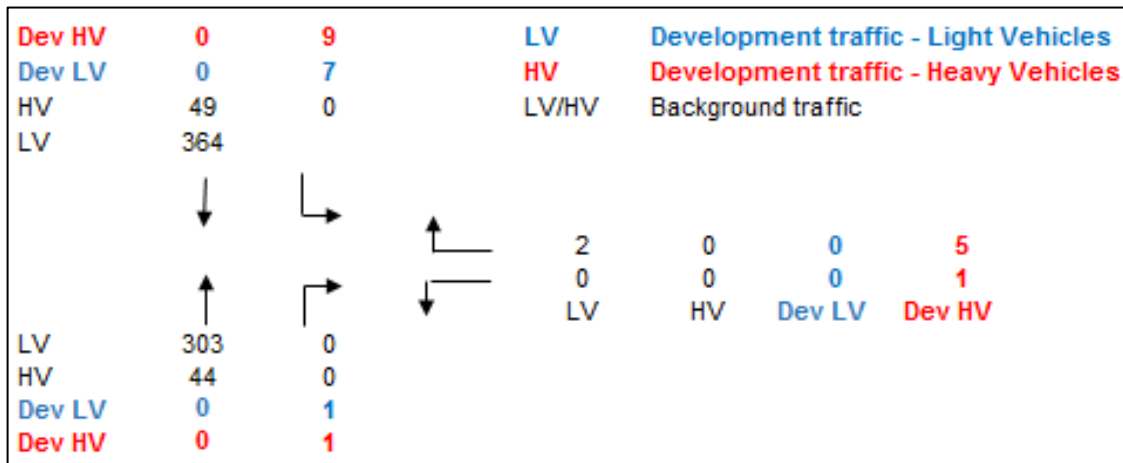

Figure 7 Estimated traffic turning movements (7 am - 8 am) for the intersection of SH1/ McLaren Gully Road (2050)

The traffic effects of the proposed development on the SH1/McLaren Gully Road intersection has been modelled using SIDRA, an industry standard computer-based analysis tool for assessing the performance characteristics of an intersection. When modelled in SIDRA, turning movements from the state highway operate with an acceptable level of service (LOS) (between A and B). However the right turn from McLaren Gully Road is expected to degrade over time and fall below an acceptable level of service around the year 2040 for the existing intersection arrangement (i.e. LOS E is reached).

⁴ Mobile Roads, estimated December 2018

5. Recommendations

5.1 State Highway 1 Intersection

Based on the above evaluation (noting that the LOS is anticipated to be below acceptable levels in the future) as well as a lighting assessment and following consultation with Waka Kotahi NZ Transport Agency, upgrades to the existing SH1/McLaren Gully Road junction are proposed. These will include:

- Flag lighting
- 3.5 m wide right turn bay with 180 m taper
- 3.5 m wide auxiliary left turn in lane with 180 m deceleration taper and painted separator
- Localised shoulder widening for left turn out movement

The above improvements are primarily required to address perceived and anticipated road safety concerns associated with increased demand on this intersection. There are secondary benefits associated with intersection efficiency and capacity. In recognition that this stretch of SH1 is used informally for passing, the auxiliary slip lane is required to provide improved driver visibility to and from McLaren Gully Road in line with the Safe System approach. Drawing C601 shows the proposed intersection upgrade.

Upgrades for both the SH1 junction and McLaren Gully Road/Big Stone Road will be completed as part of the site establishment process ahead of operational waste disposal.

GHD also undertook a Speed Management Assessment of the intersection of SH1/McLaren Gully Road. The purpose of this assessment was to determine whether a reduction in speed limit through the intersection would be justified, specifically due to the predicted increase of heavy vehicle turning movements associated with the proposed development at Smooth Hill.

The assessment considered safety, traffic speeds and volumes, the road environment and the ten-year crash history. The assessment concluded that implementing an Intersection Speed Zone (ISZ) using Rural Intersection Activated Warning Signs (RIAWS) at this location would be suitable and provide an improvement on safety without having to permanently lower the speed limit in the area. The ISZ would be activated when a vehicle approaches SH1 from McLaren Gully Road, slowing oncoming traffic on the state highway to 80 km/h. When the intersection is not in use, a 100 km/h speed limit would be in effect. In this way, traffic on the state highway is only slowed when required.

Through consultation with the New Zealand Transport Agency, it was identified that the Allanton-Waihola Highway is being considered as part of an overall corridor speed management study. As the study will consider the intersection of SH1/McLaren Gully Road and provide recommendations, the Transport Agency decided against supporting RIAWS at the intersection until the study is complete. The timing of the corridor speed management study is unknown.

6. Conclusion

A new regional landfill is proposed approximately 28 km south-west of Dunedin at a site known as Smooth Hill. This site has been designated as a future municipal landfill site for a number of years to meet the future waste management requirements of Dunedin as the Green Island Landfill reaches the end of its life span.

This report has assessed the transportation aspects of the project during both the construction and the operational phases, as well giving due consideration to the long-term future scenario; the Smooth Hill Landfill is designed to provide for the safe disposal of municipal solid waste for a period [in the order of 40 years in excess of 35 years](#).

The key matters assessed in this report are listed below:

- During the site establishment phase and periods of construction (recurring every two to five years), there will be an increase in heavy vehicle movements on McLaren Gully Road as earthwork machinery is transported to the site. It is considered that the site establishment and construction activities are able to be appropriately managed with the implementation of a CTMP so that any temporarily generated traffic effects are acceptable.
- During the operational phase, on average, 104 heavy waste vehicles are predicted to arrive and leave on any particular day (across the year). In practice, this total number of heavy vehicles may fluctuate across any given day due to seasonality or operational requirements and additional heavy vehicles are also likely to be required (including leachate removal and water deliveries during the first few year of operation). Therefore, it has been assumed truck movements could be up to approximately 25 per day with potentially up to an additional approximate 25 light vehicles per day.
- With consideration of the existing use of McLaren Gully Road and the current traffic volumes on SH1 (approximately 7,400 vehicles per day with 12% heavy vehicles⁵), an increase of up to 25 heavy vehicles trips a day to and from the landfill site will have no noticeable effect on the operation of the receiving road environment. The increase in traffic is not anticipated to impact driveway accessibility for residents on Maclaren Gully Road or Big Stone Rod.
- The intersection of SH1 and McLaren Gully Road is to be upgraded with flag lighting, a right turn bay and a left turn deceleration lane in line with the Safe System approach.
- The above improvements are primarily required to address perceived and anticipated road safety concerns associated with increased demand on this intersection. There are secondary benefits associated with intersection efficiency and capacity.
- It has also been recommended that the intersection of SH1 and McLaren Gully Road is considered for an 80 km/h ISZ implemented using RIAWS. The Transport Agency's corridor speed management study for the Allanton-Waihola Highway will determine if this recommendation is adopted.

Overall, it is expected that the transportation effects of the Smooth Hill landfill can be suitably managed with very minor adverse effects on the surrounding transport environment with the adoption of the recommended changes to the junction layout.

⁵ Mobile Roads, estimated December 2018

7. Limitations

This report: has been prepared by GHD for Dunedin City Council (Client) and may only be used and relied on by Client for the purpose agreed between GHD and Client as set out in Section 1 of this report.

GHD otherwise disclaims responsibility to any person other than the Client and Council officers, consultants, the hearings panel and submitters associated with the resource consent and notice of requirement process for the Smooth Hill Landfill Project arising in connection with this report. GHD also excludes implied warranties and conditions, to the extent legally permissible.

The services undertaken by GHD in connection with preparing this report were limited to those specifically detailed in the report and are subject to the scope limitations set out in the report.

The opinions, conclusions and any recommendations in this report are based on conditions encountered and information reviewed at the date of preparation of the report. GHD has no responsibility or obligation to update this report to account for events or changes occurring subsequent to the date that the report was prepared.

The opinions, conclusions and any recommendations in this report are based on assumptions made by GHD described in this report. GHD disclaims liability arising from any of the assumptions being incorrect.

GHD has prepared this report on the basis of information provided by Client and others who provided information to GHD (including Government authorities)], which GHD has not independently verified or checked beyond the agreed scope of work. GHD does not accept liability in connection with such unverified information, including errors and omissions in the report which were caused by errors or omissions in that information.

8. References

GHD, 2021a, *Waste Future Phase 2 – Workstream 3 Smooth Hill Landfill – Landfill Concept Design Report*. Project reference:12506381

GHD, 2021b, *Smooth Hill Landfill Consenting - Surface Water Report*
Project Reference:12506381

GHD, 2021c, *Smooth Hill Landfill Consenting – Preliminary Site Investigation Report*
Project Reference:12506381

This report has been prepared in part by Laura Goodman, a civil engineer at GHD Ltd. Laura has 4 years experience as a civil engineer. Laura worked under the direction and supervision of Andrew Whaley. [Nick Eldred also contributed to sections of the report.](#) Andrew has 26 experience with roading and other infrastructure projects and has the following qualifications and institutional memberships: BCivil, CPEng (UK) and a member of MICE and member of the Society of Construction Law.

GHD

Level 3





138 Victoria Street

T: 64 3 378 0900 F: E: chcmail@ghd.com

© GHD 2019

This document is and shall remain the property of GHD. The document may only be used for the purpose for which it was commissioned and in accordance with the Terms of Engagement for the commission. Unauthorised use of this document in any form whatsoever is prohibited.

Document Status

Revision	Author	Reviewer		Approved for Issue		
		Name	Signature	Name	Signature	Date
Rev01	Laura Goodman	Andrew Whaley		Stephen Douglass		18-8-20
Rev02	Laura Goodman	Andrew Whaley		Stephen Douglass		27-05-21

www.ghd.com



