

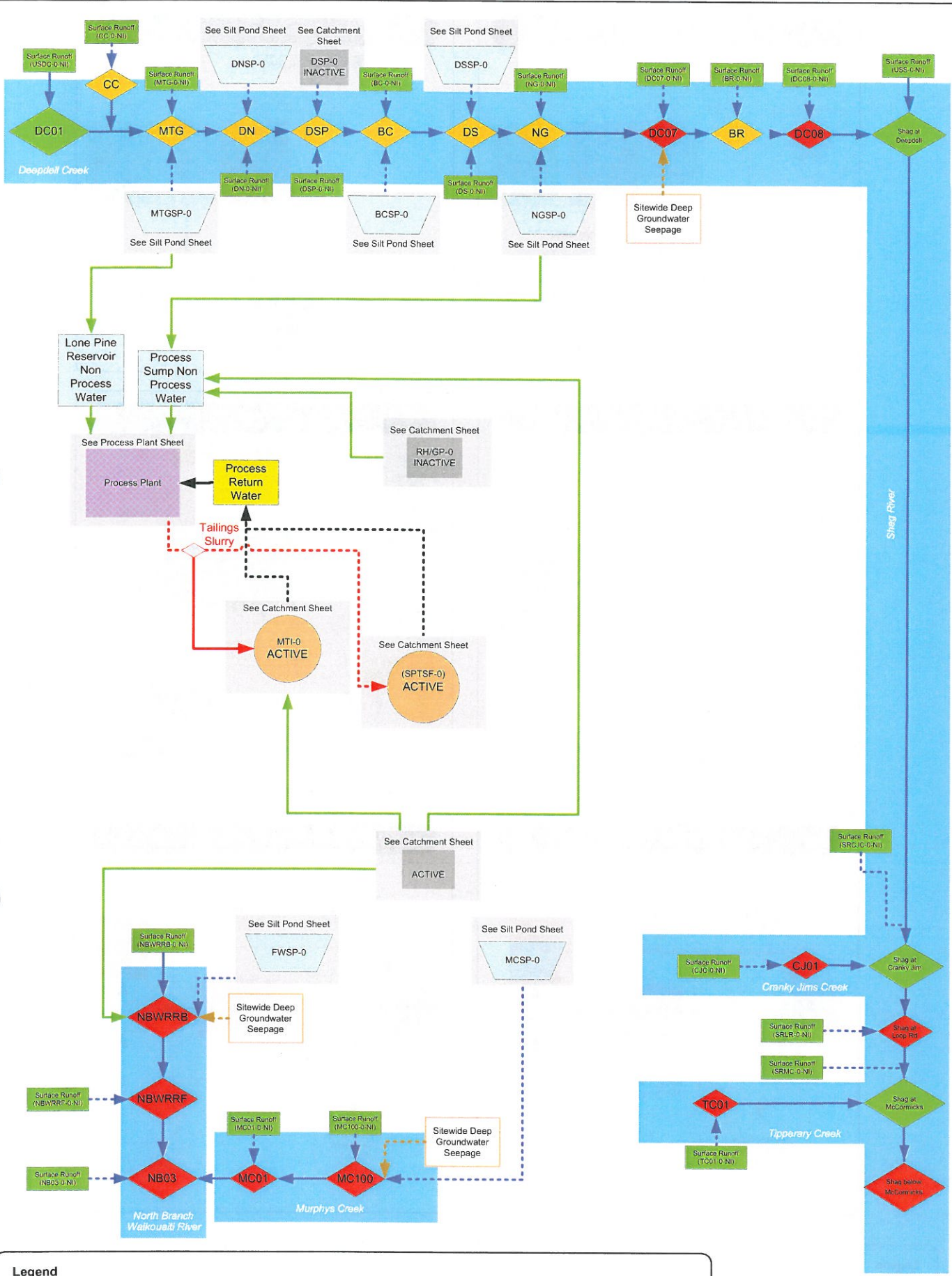

# APPENDIX B

## Conceptual Model



**Legend**

	Rainfall		Tailings Slurry Water		Ephemeral Stream/River/Waterway
	Evaporation		Process Return Water (Pumped)		Permanent Stream/River/Waterway
	Tailings Slurry Water (Closed)		Groundwater Seepage		Non Process Water (pumped)

1. Schematic only, not to be interpreted as an engineering design or construction drawing.

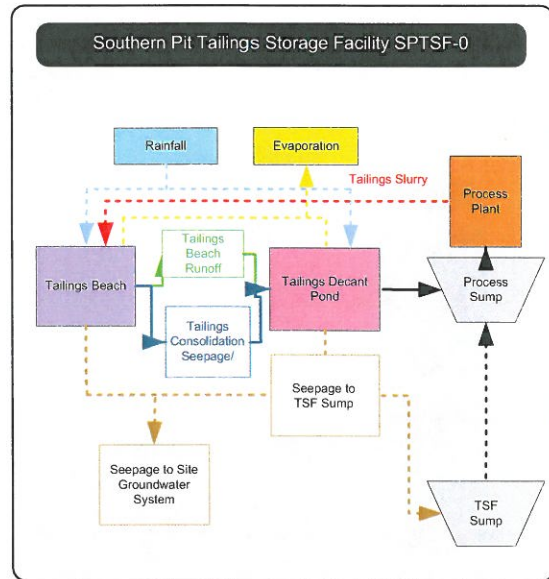
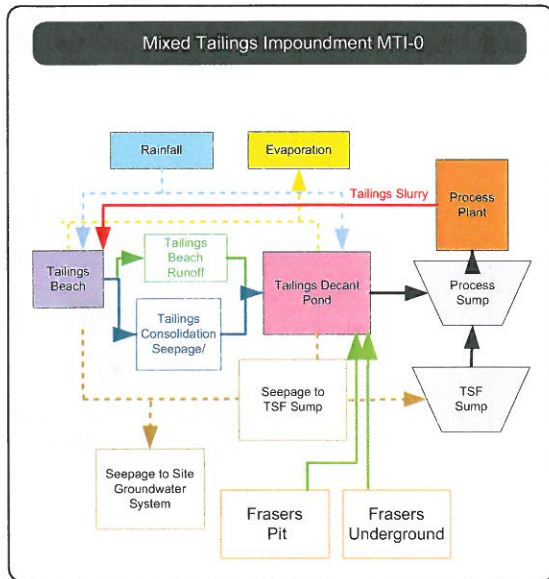
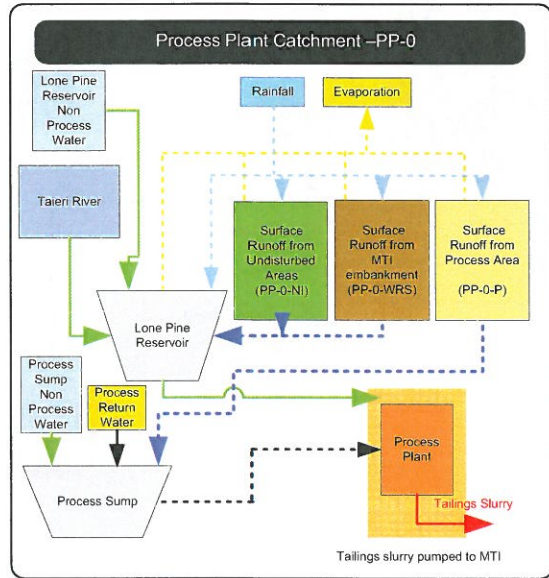
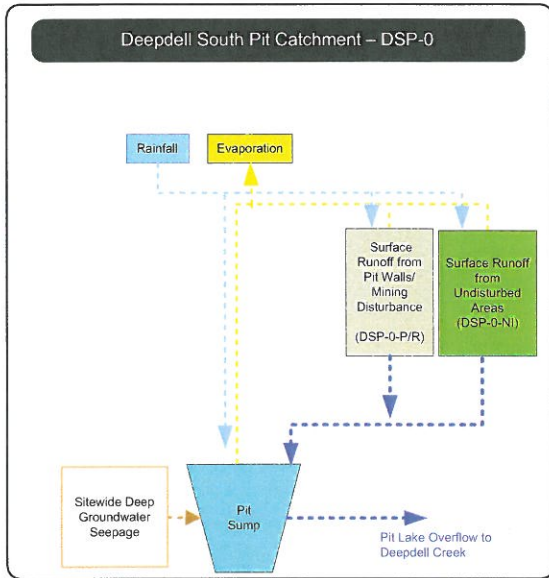
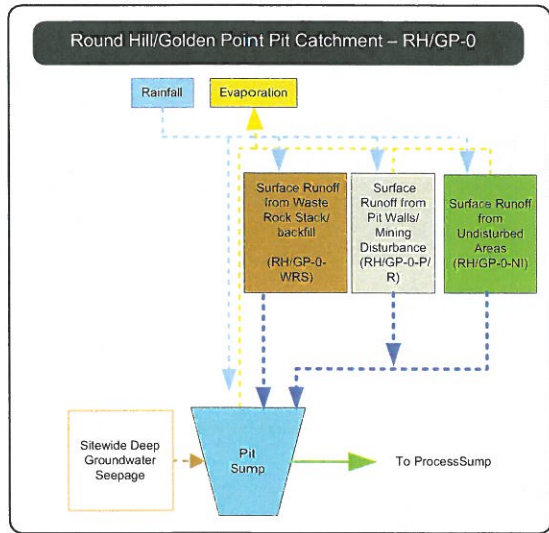
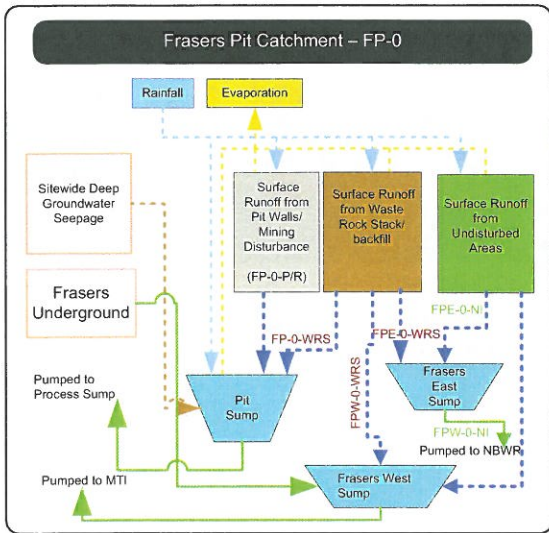

1. Schematic only not to be interpreted as an engineering design or construction drawing





Information contained in this drawing is the copyright of Golder Associates (NZ) Ltd. Unauthorised use or reproduction of this plan either wholly or in part without permission infringes copyright. © Golder Associates (NZ) Ltd.

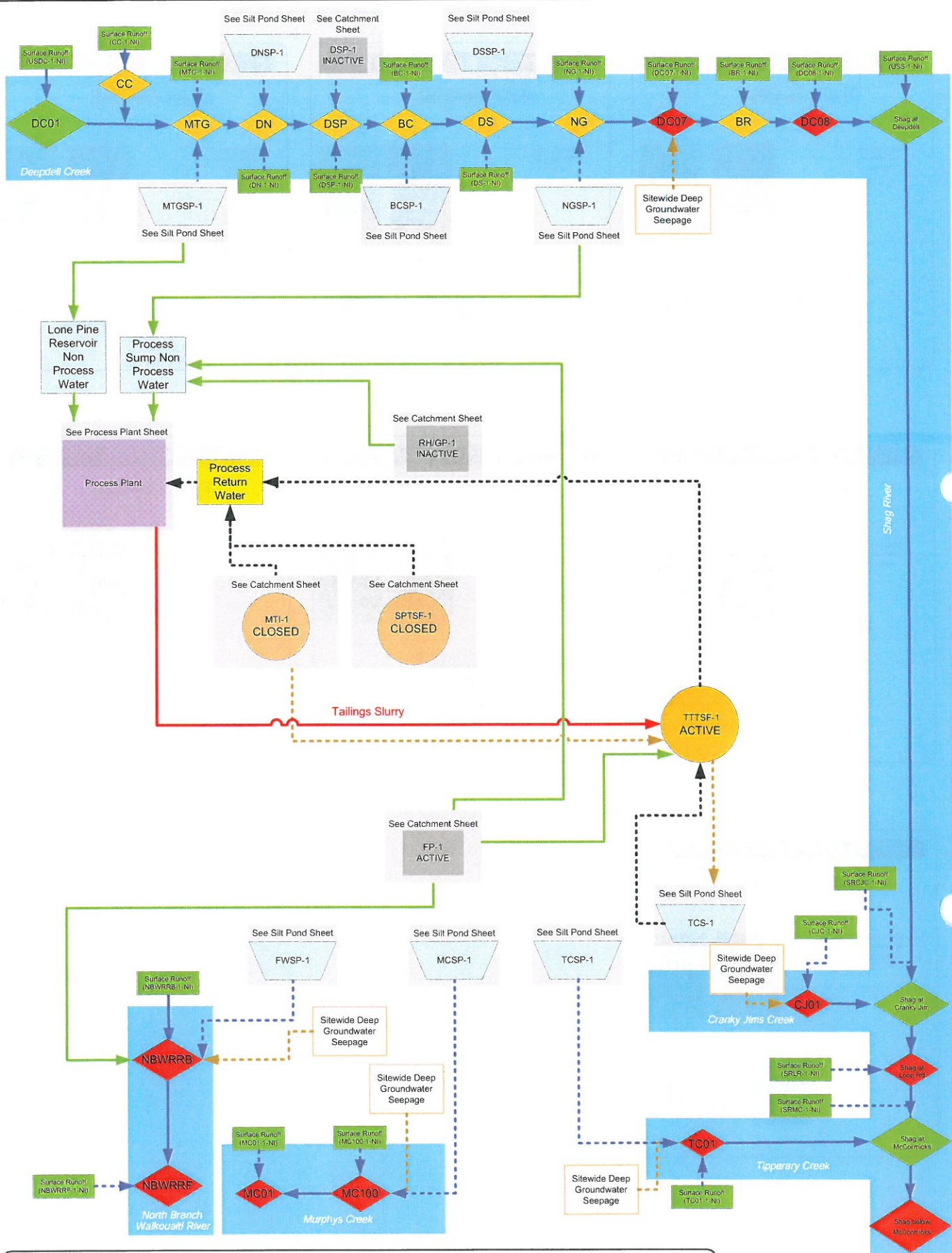

**Legend**

	Rainfall		Tails Slurry Water		Ephemeral Stream/River/Waterway
	Evaporation		Process Return Water (Pumped)		Permanent Stream/River/Waterway
	Tails Slurry Water (Closed)		Groundwater Seepage		Non Process Water (pumped)

1. Schematic only, not to be interpreted as an engineering design or construction drawing





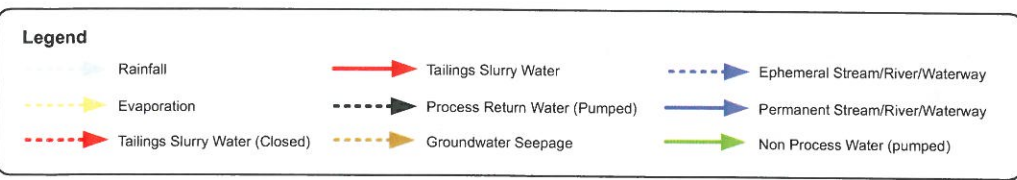
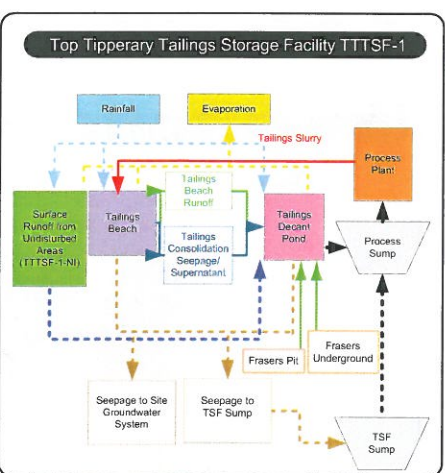
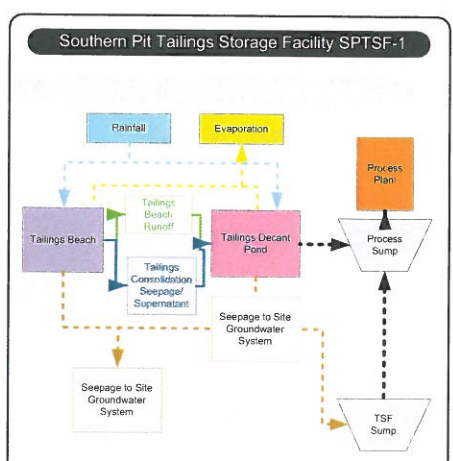
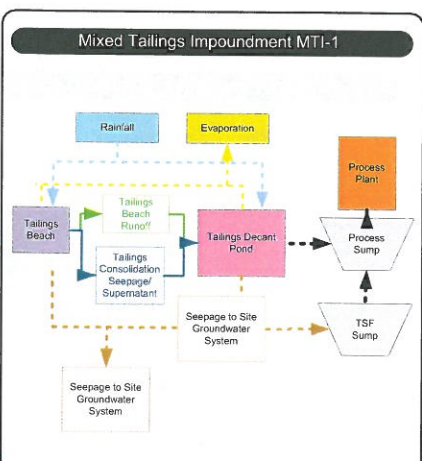
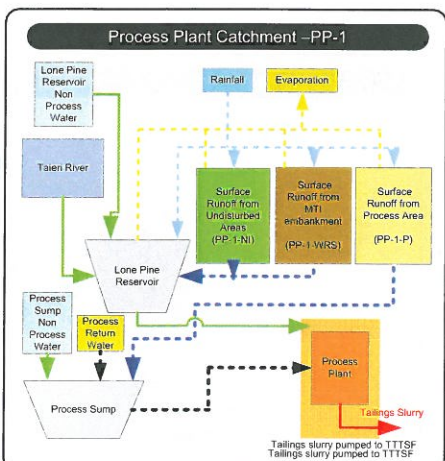
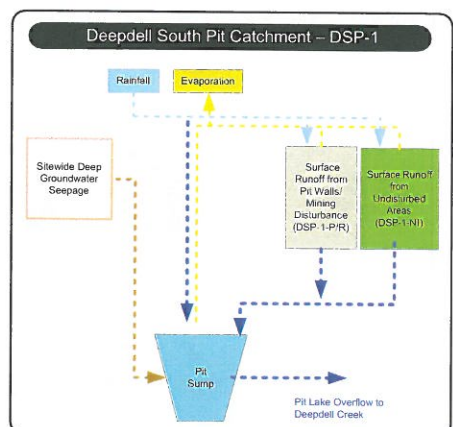
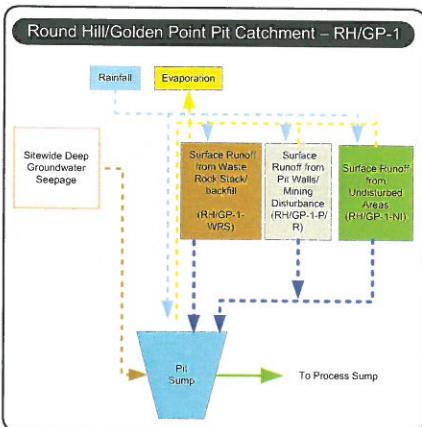
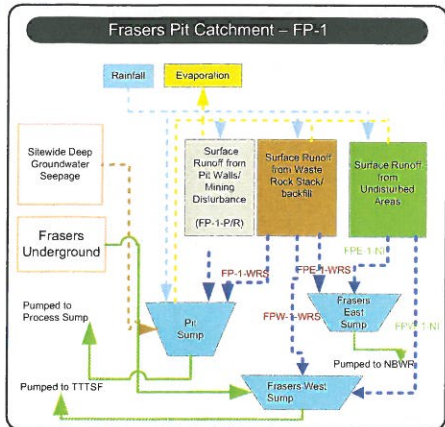

1. Schematic only, not to be interpreted as an engineering design or construction drawing

Information contained in this drawing is the copyright of Golder Associates (NZ) Ltd. Unauthorised use or reproduction of this plan either wholly or in part without written permission is strictly prohibited. Golder Associates (NZ) Ltd.



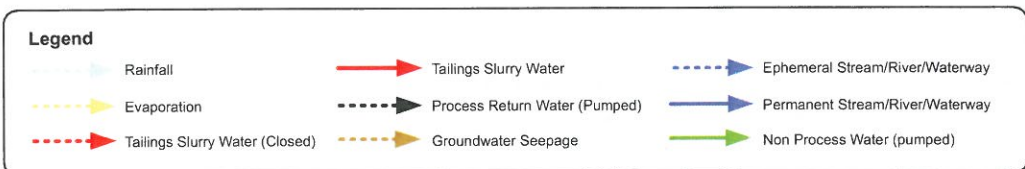
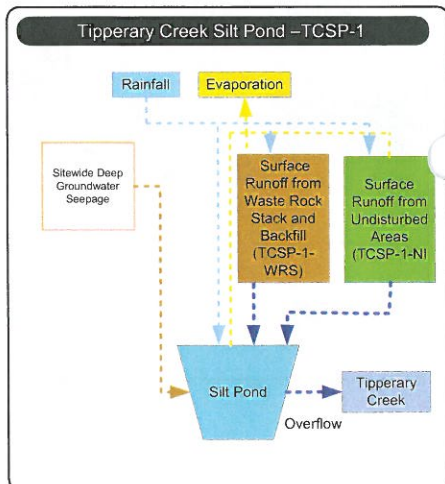
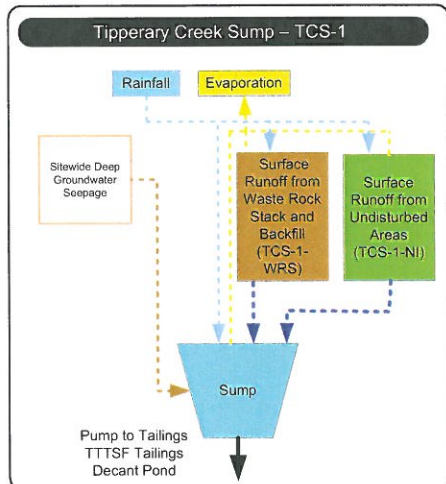
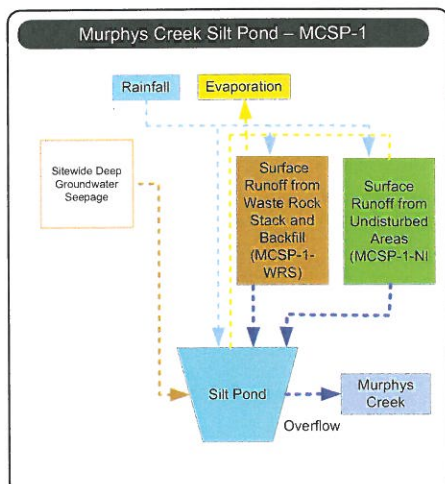
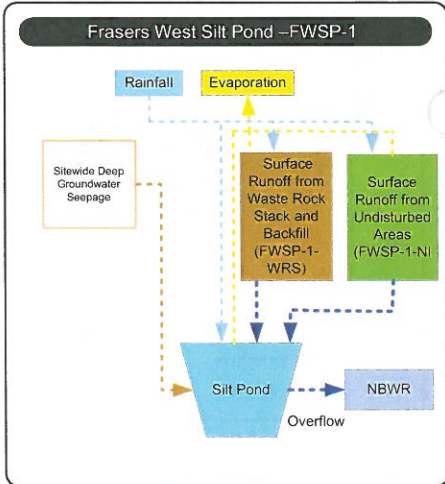
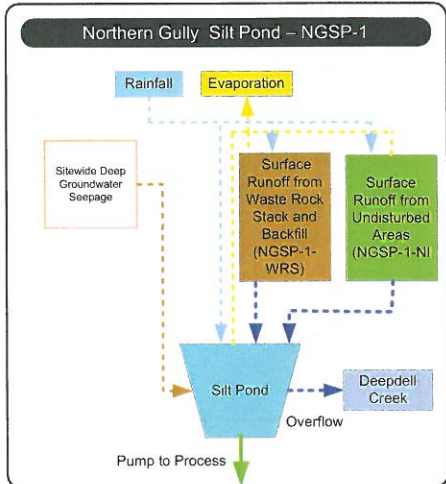
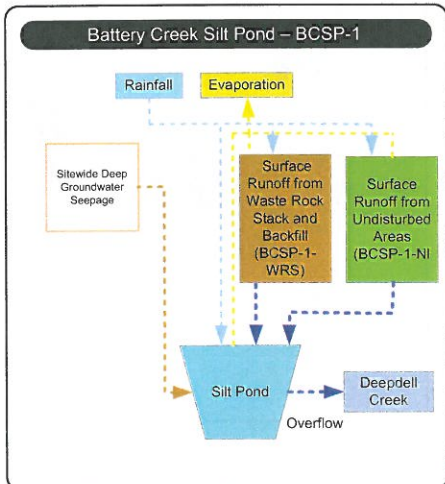
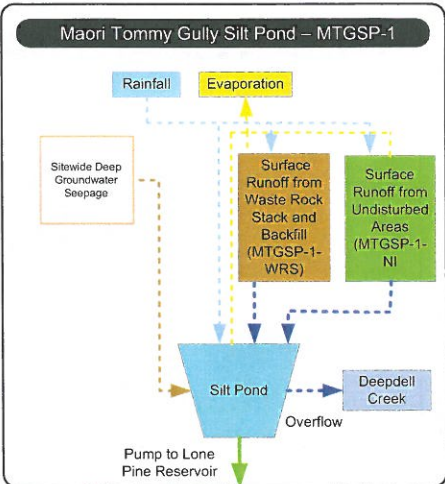
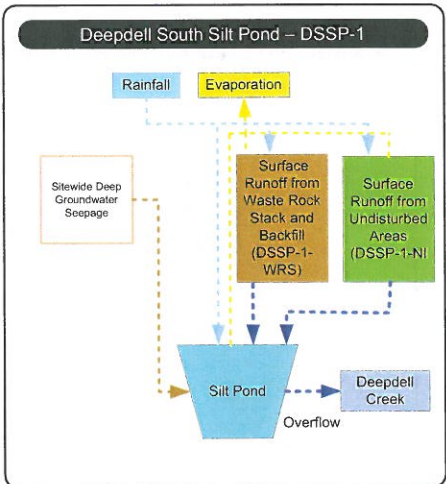
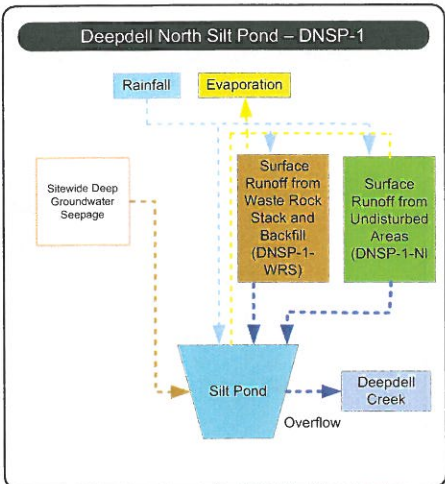

1. Schematic only, not to be interpreted as an engineering design or construction drawing

Information contained in this drawing is the copyright of Golder Associates (NZ) Ltd. Unauthorised use or reproduction of this plan either wholly or in part without written permission infringes copyright. © Golder Associates (NZ) Ltd.



Water Associates (NZ) Ltd

Information contained in this drawing is the copyright of Water Associates (NZ) Ltd. Unauthorised use or reproduction of this plan either wholly or in part without written permission is strictly prohibited.

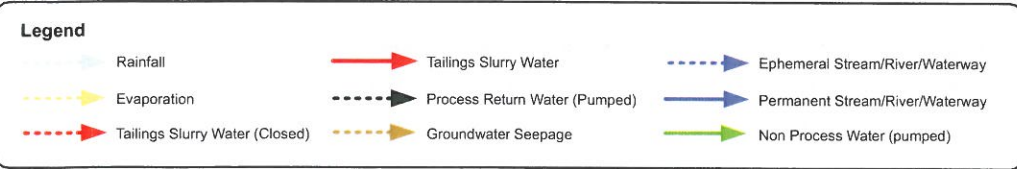
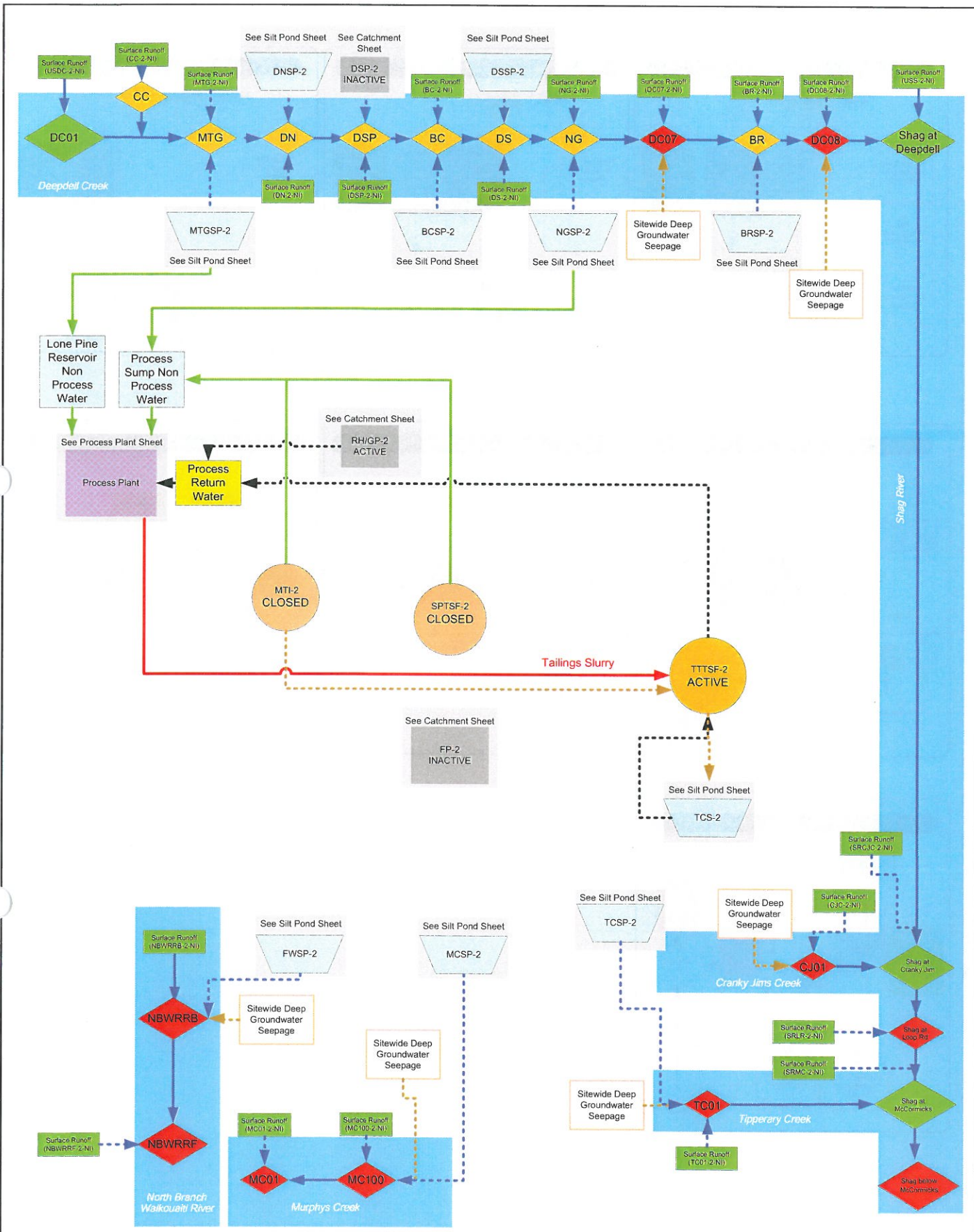

1. Schematic only; not to be interpreted as an engineering design or construction drawing





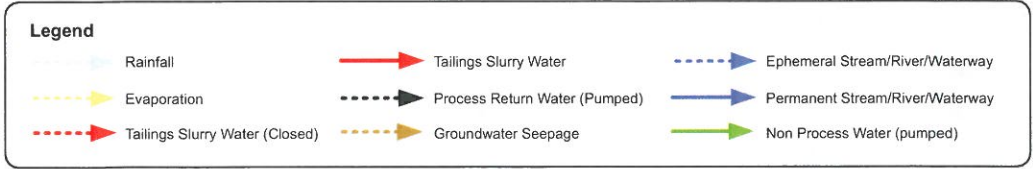
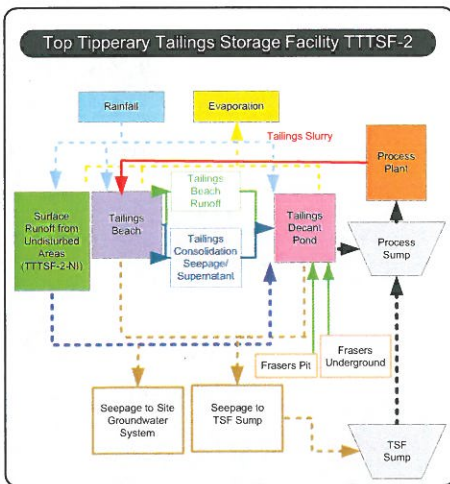
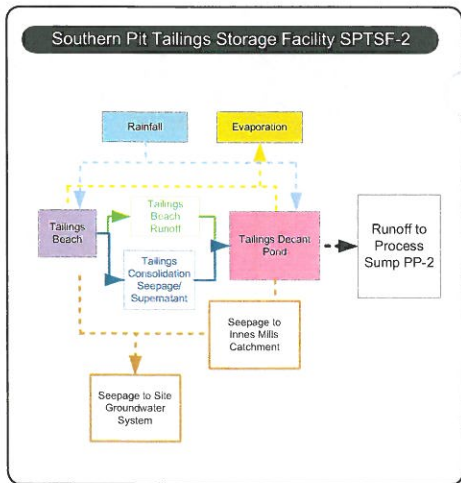
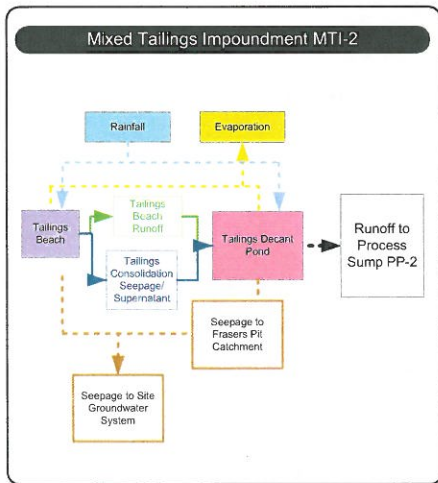
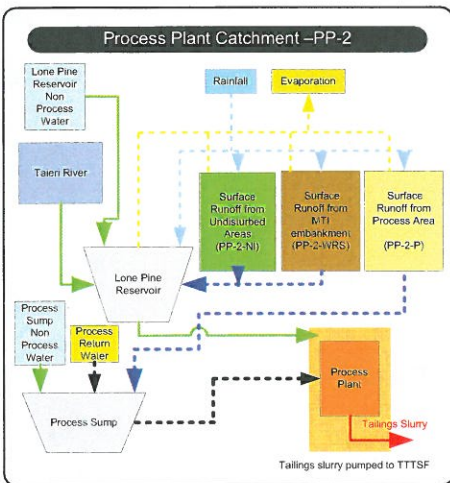
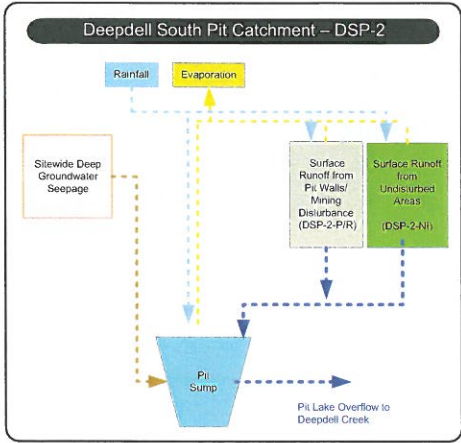
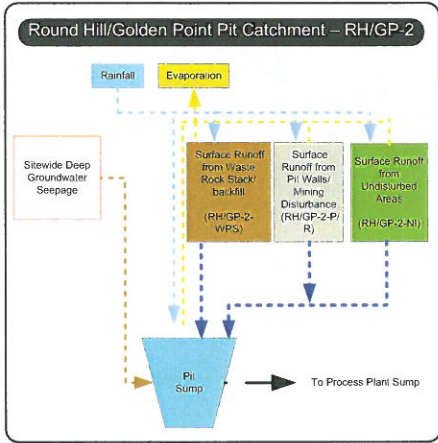
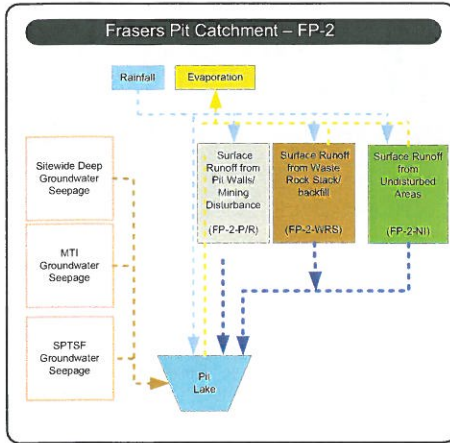

1 Schematic only, not to be interpreted as an engineering design or construction drawing

Information contained in this drawing is the copyright of Golder Associates (NZ) Ltd. Unauthorised use or reproduction of this plan either wholly or in part without written permission is prohibited. © Golder Associates (NZ) Ltd.



Information contained in this drawing is the copyright of Golder Associates (NZ) Ltd. Unauthorised use or reproduction of this plan either wholly or in part without written permission infringes copyright.

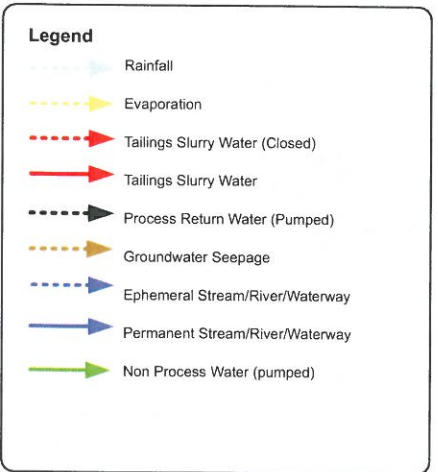
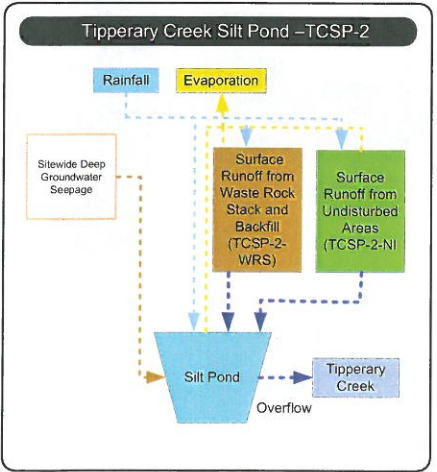
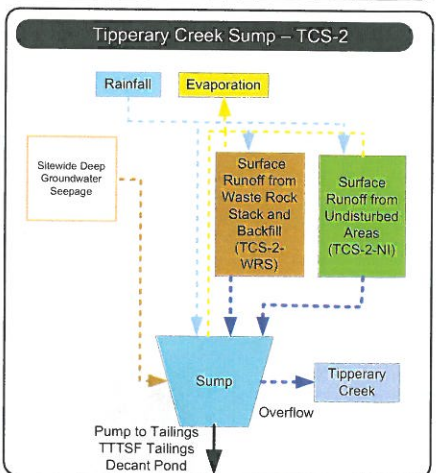
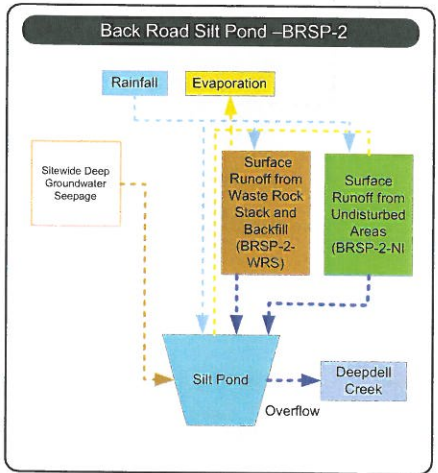
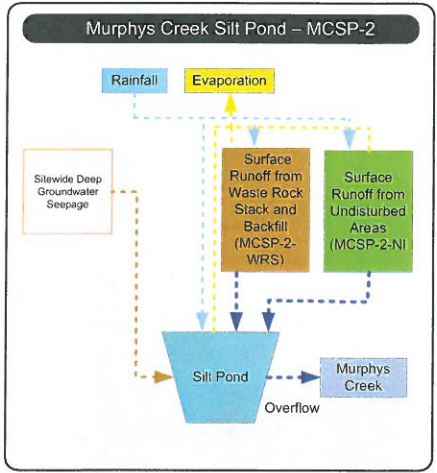
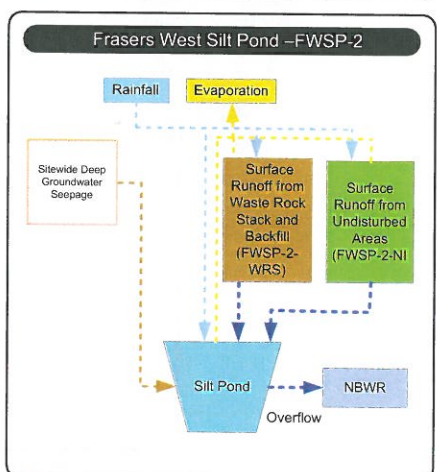
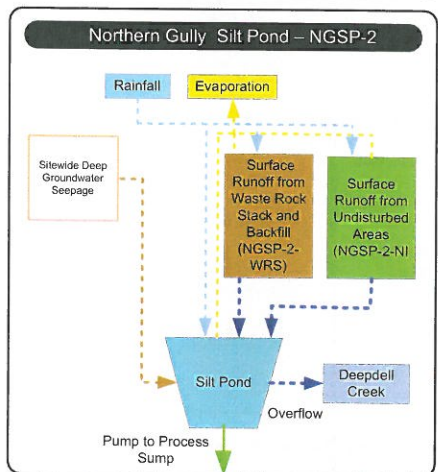
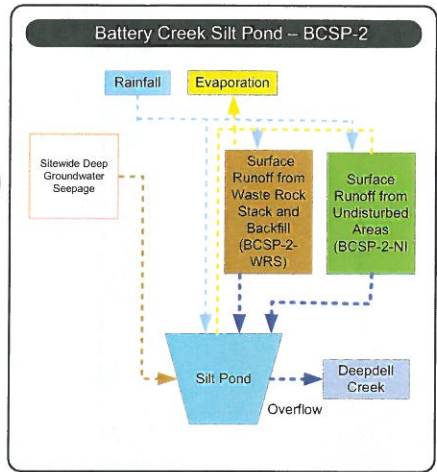
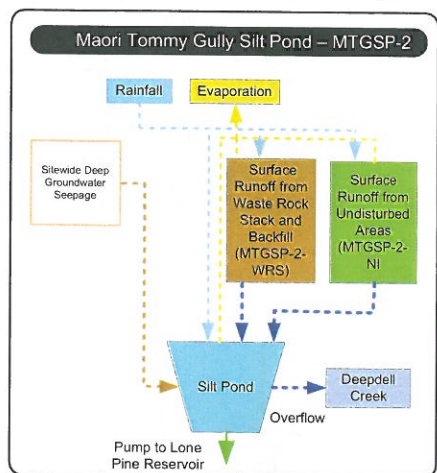
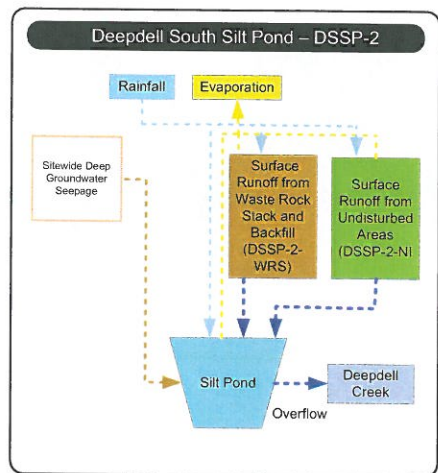
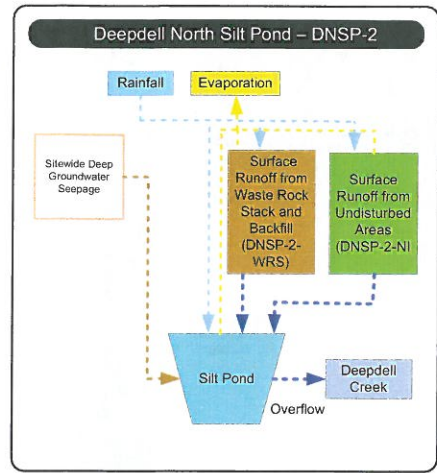

1 Schematic only, not to be interpreted as an engineering design or construction drawing





Information contained in this drawing is the copyright of Golder Associates (NZ) Ltd. Unauthorised use or reproduction of this plan either wholly or in part without written permission infringes copyright. © Golder Associates (NZ) Ltd.

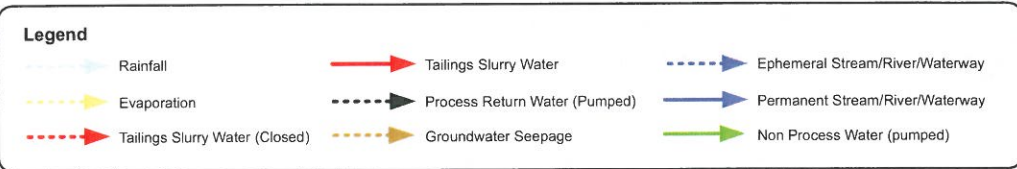
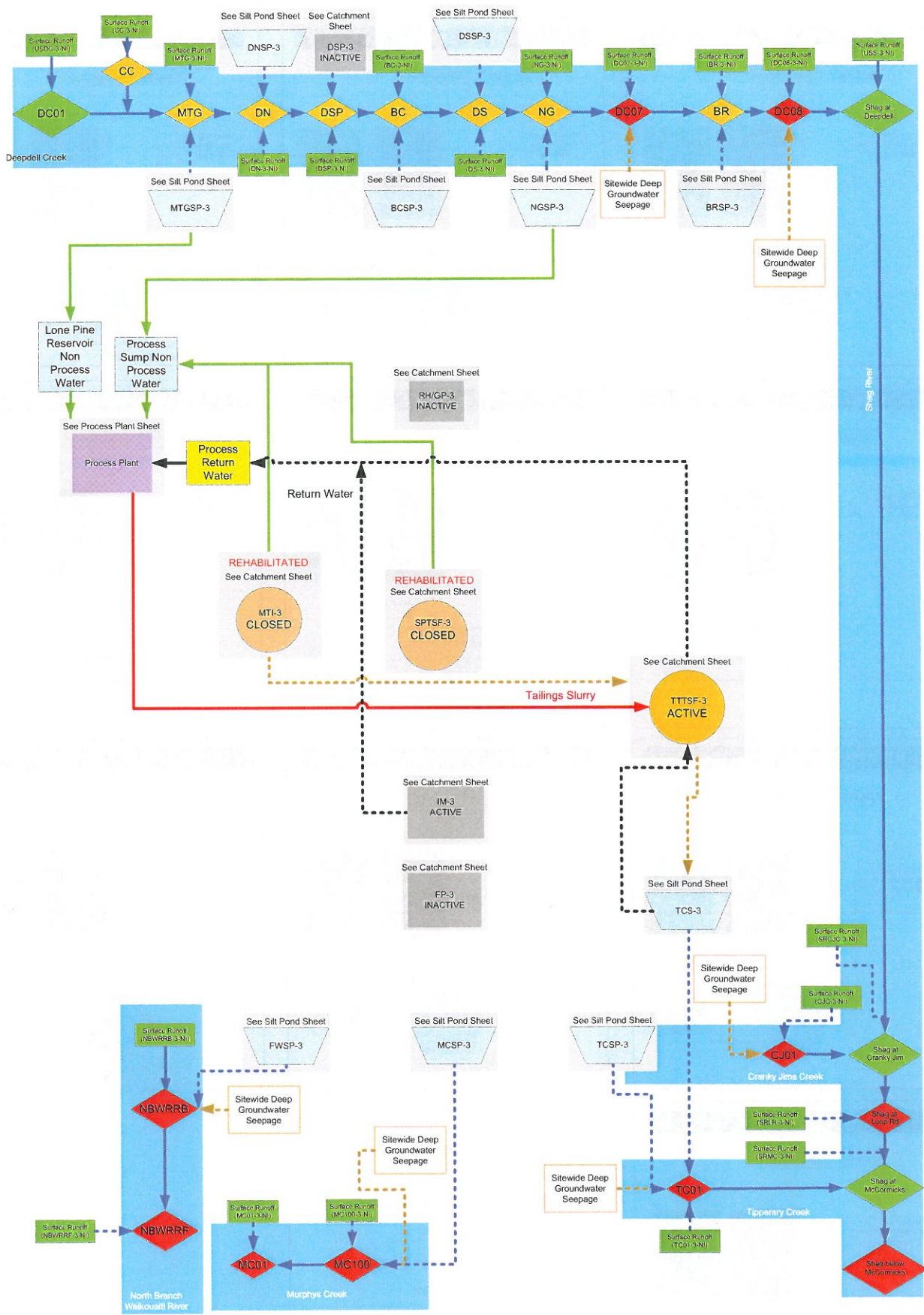

1. Schematic only, not to be interpreted as an engineering design or construction drawing



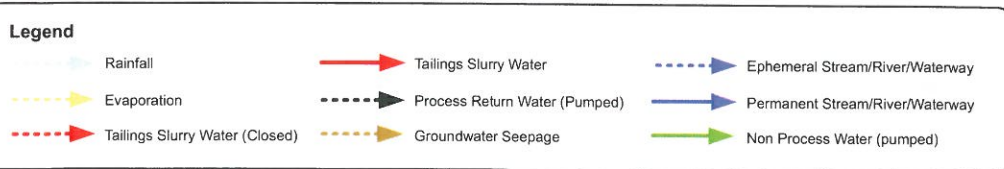
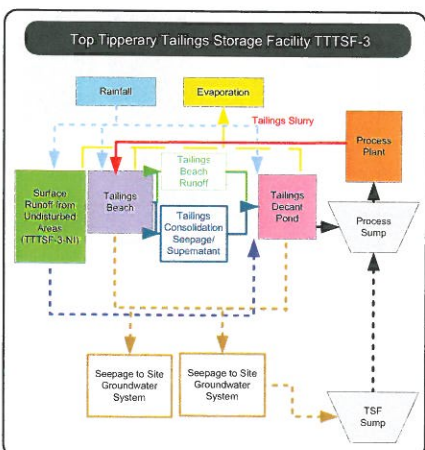
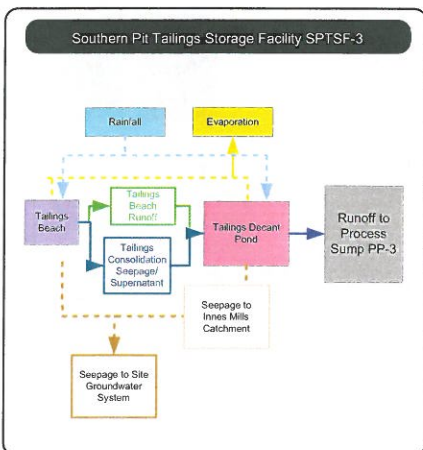
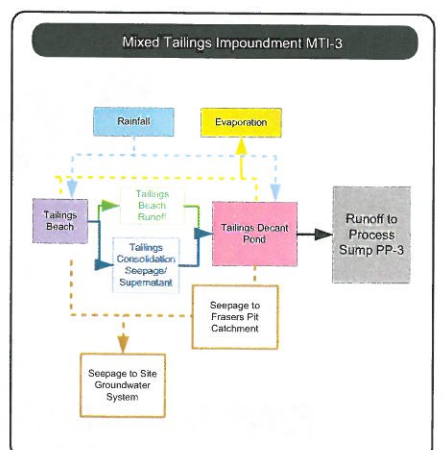
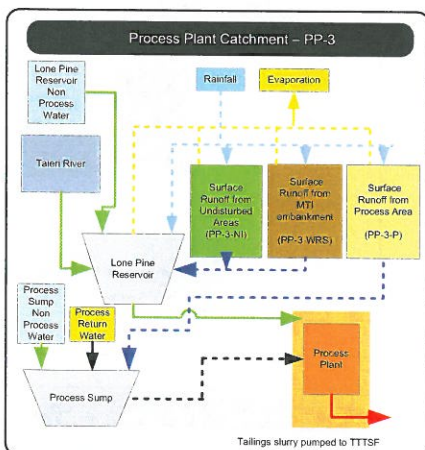
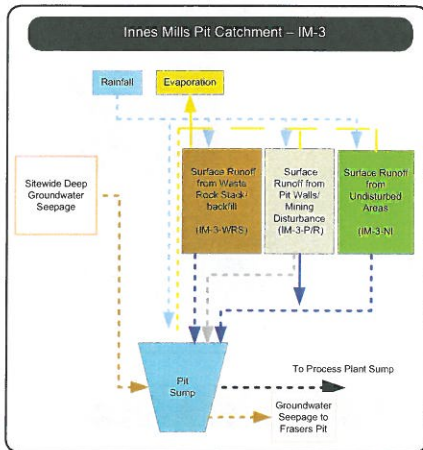
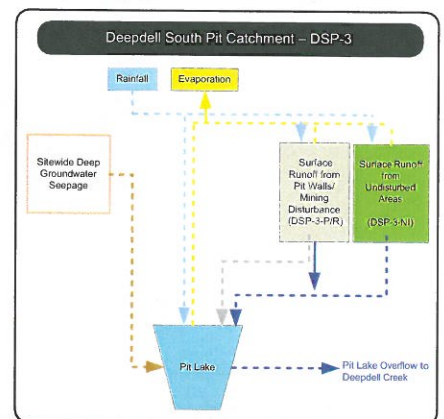
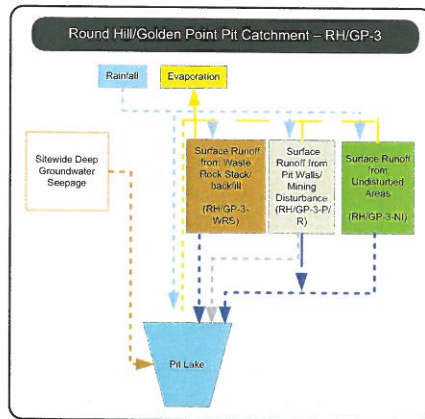
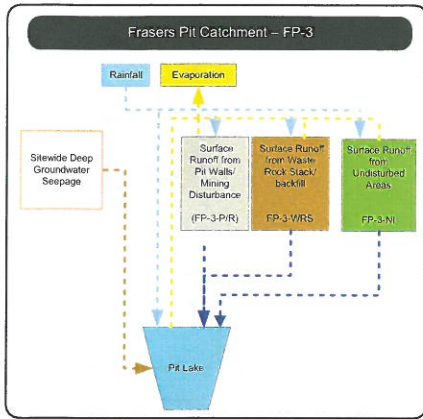

Information contained in this drawing is the copyright of Golder Associates (NZ) Ltd. Unauthorised use or reproduction of this plan, either wholly or in part without written permission infringes copyright.

1. Schematic only, not to be interpreted as an engineering design or construction drawing





Information contained in this drawing is the copyright of Golder Associates (NZ) Ltd. Unauthorised use or reproduction of this plan either wholly or in part without written permission infringes copyright. © Golder Associates (NZ) Ltd.

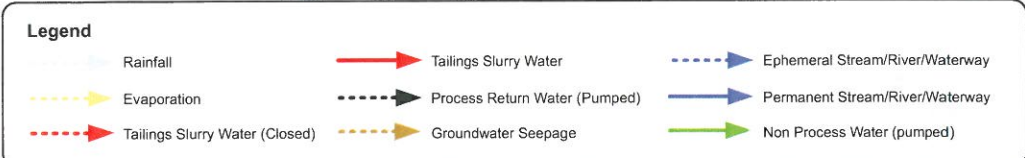
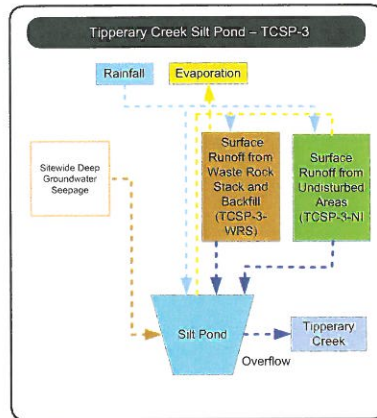
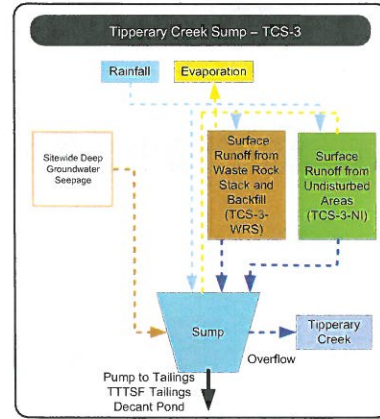
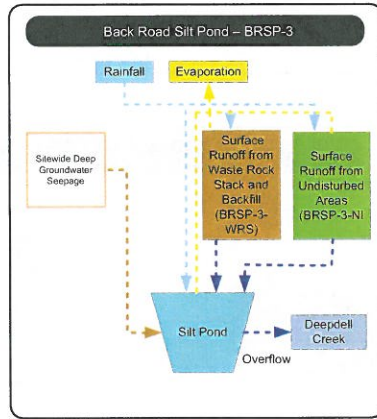
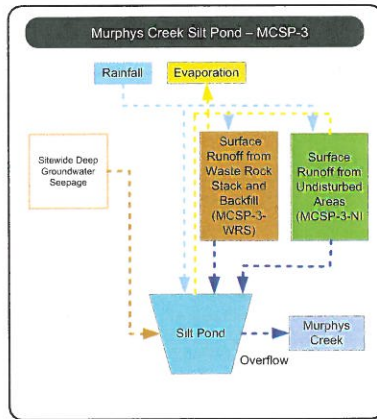
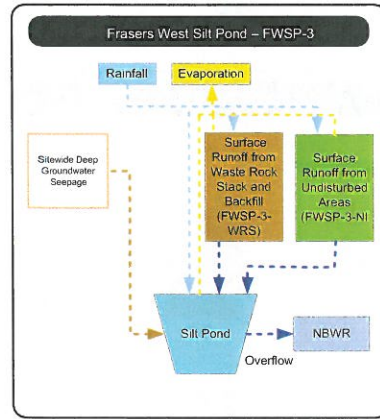
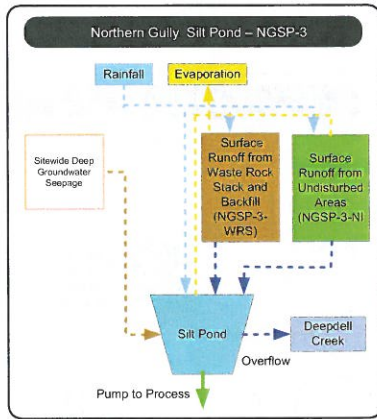
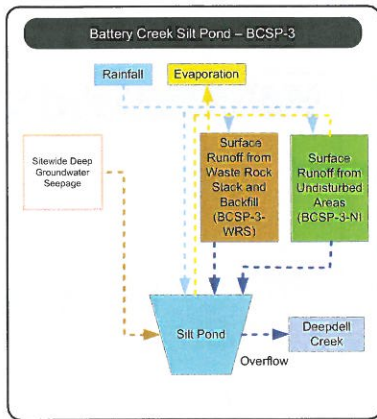
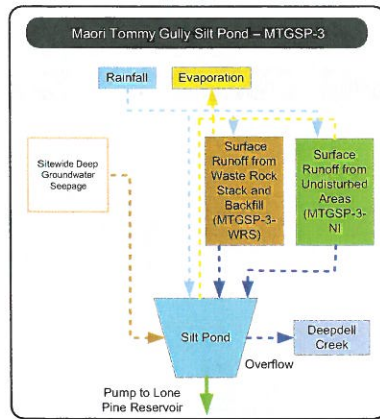
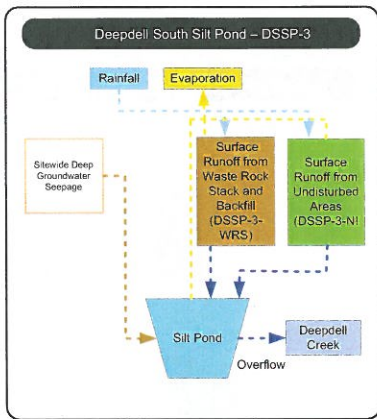
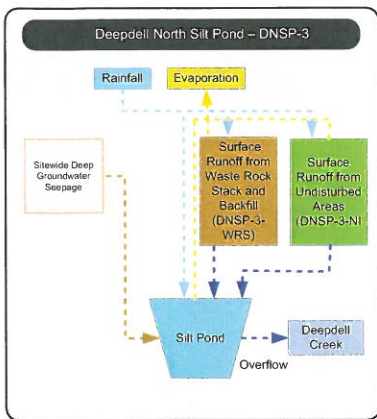

1. Schematic only, not to be interpreted as an engineering design or construction drawing







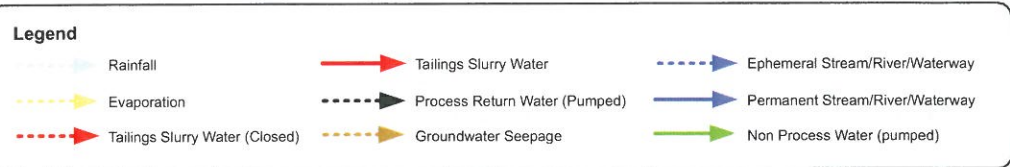
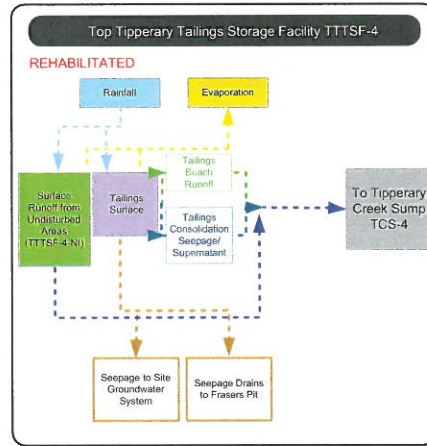
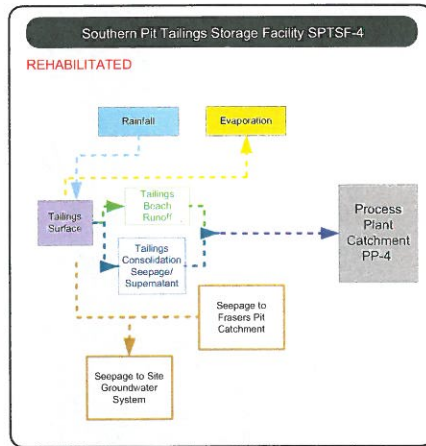
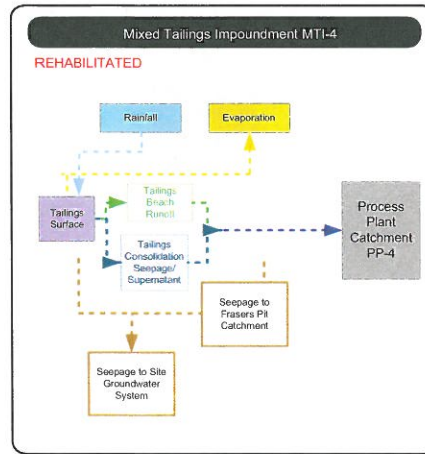
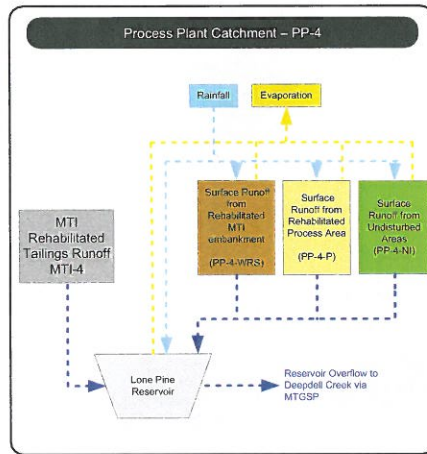
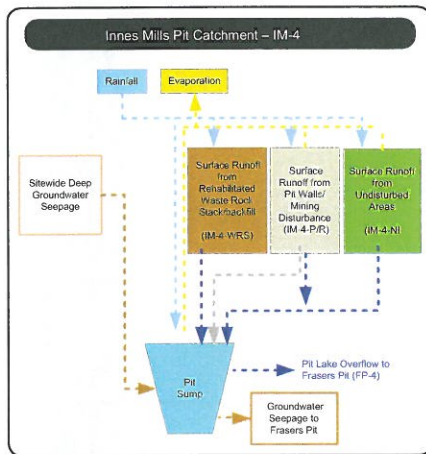
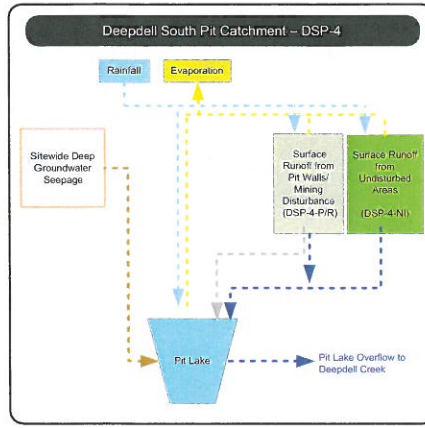
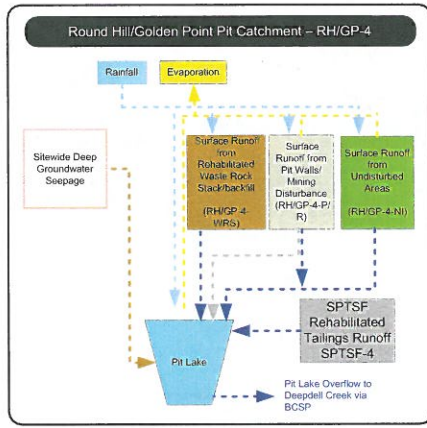
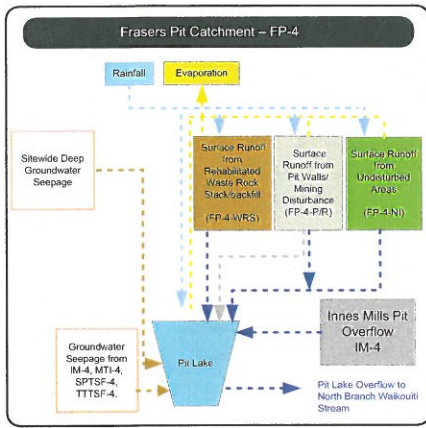

1. Schematic only, not to be interpreted as an engineering design or construction drawing.

Information contained in this drawing is the copyright of Golder Associates (NZ) Ltd. (unauthorised use or reproduction of this plan other than in part without written permission infringes copyright).  
Golder Associates (NZ) Ltd.

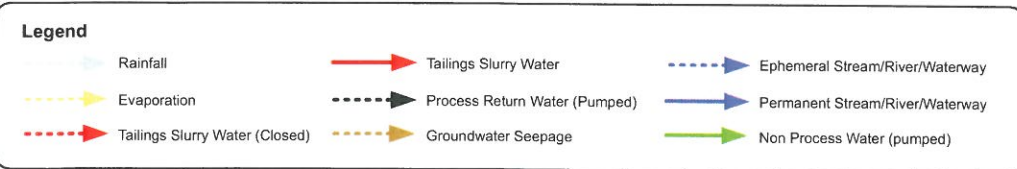
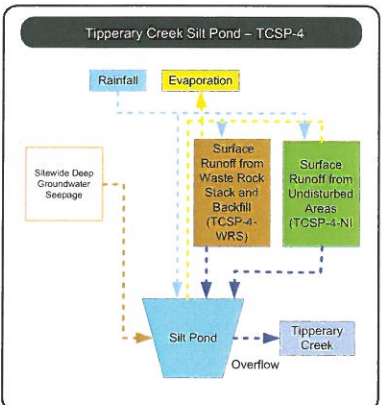
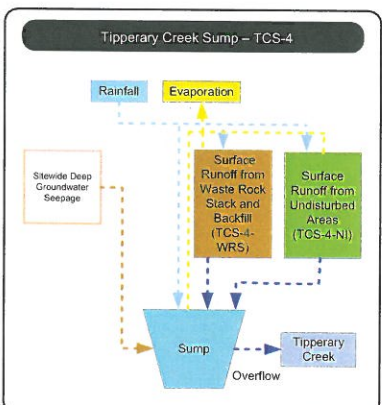
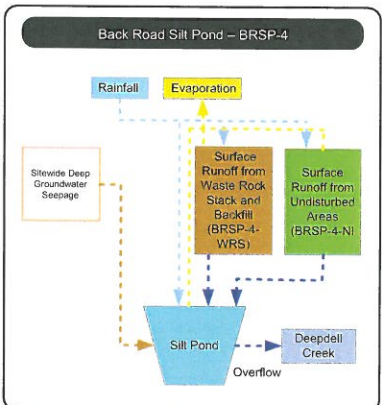
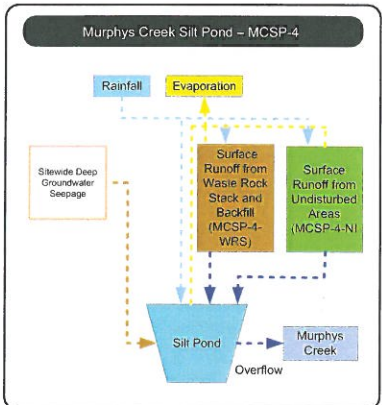
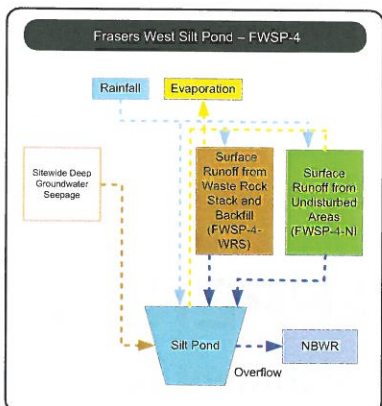
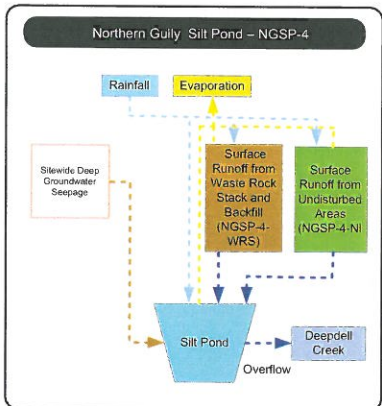
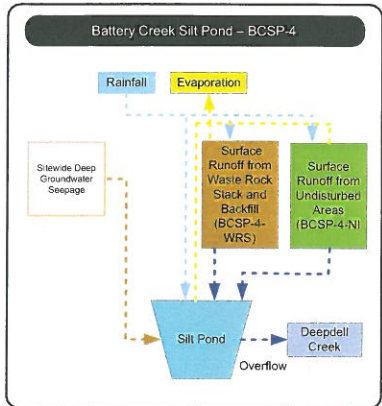
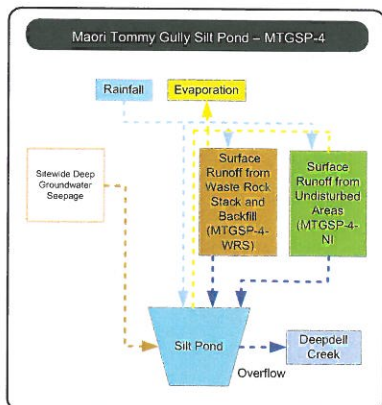
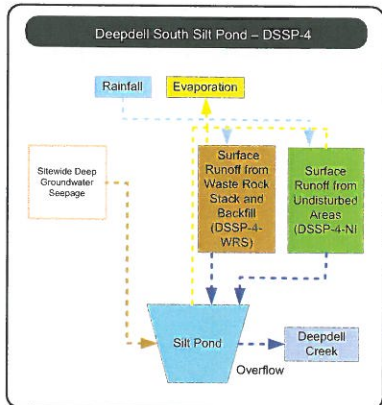
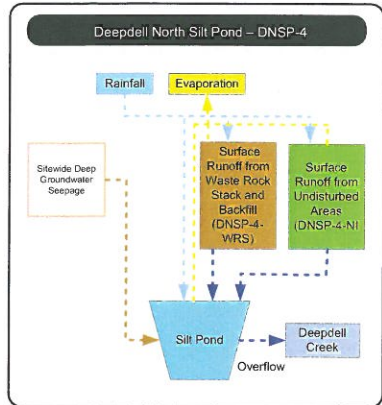

1. Schematic only, not to be interpreted as an engineering design or construction drawing

