

---

# PRACTICE NOTE 27

## DAIRY FARM INFRASTRUCTURE

---

Engineering Practice

ISSN 1176-0907  
Version 2, August 2017



**DairyNZ** 

An Investment by New Zealand Dairy Farmers



# PREFACE

The purpose of this Practice Note is to provide good practice guidance on the design and construction of some key infrastructure components where their performance and operation is impacted by Farm Dairy Effluent (FDE). It is a good-practice reference source for engineering practitioners, contractors, agriculturists, product suppliers, regional council and local authority staff and others involved in the New Zealand dairy industry.

The information contained in this Practice Note is relevant for farm owners and operators, designers, constructors and consenting authorities. It is important that all people involved in the design or construction of farm infrastructure follow this guidance whether they are Chartered Professional Engineers (CPEng) and members of the Institution of Professional Engineers New Zealand (IPENZ), or otherwise regarded as competent by consenting authorities. It should also be noted that regional councils may draw on the guidance in this Practice Note when producing their own policies related to structures that have contact with effluent.

This document is complementary to the following previously released dairy industry IPENZ Practice Notes:

*Practice Note 21: Farm Dairy Effluent Pond Design and Construction (PN21)*

*Practice Note 29: Dairy Housing (PN29).*

While this Practice Note specifically refers to FDE, there are other agricultural industries that produce effluent that may benefit from this guidance.

# PRACTICE NOTE DEVELOPMENT

The Institution of Professional Engineers New Zealand (IPENZ), together with support from principal sponsors DairyNZ, has allowed the development of this Practice Note which includes considered inputs from professional civil, structural, agricultural and environmental engineers working within the wider New Zealand rural industry.

The IPENZ Engineering Practice Advisory Committee (EPAC) has given the Practice Note lead author the task of preparing a document that reflects a national perspective to be adopted by the dairy engineering industry.

Version 1 of this Practice Note was released in September 2013. Version 2 provides details on the Health and Safety at Work Act (2015) and provides updates on other relevant regulations.

This Practice Note has been prepared in accordance with standard IPENZ Practice Note procedures. This included reporting on progress to EPAC, peer review and general membership review. The review and reporting process ensures the delivery of a robust, good-practice technical document. While the lead author and other contributors have made every effort to present a carefully considered Practice Note based on New Zealand professional practice, as well as consultation with the wider industry, they accept that what constitutes good practice may alter over time following changes in knowledge, technology and legislation. They also acknowledge that differing interpretations of relevant legislation and regulations are possible. Therefore, users of the information provided need to confirm with the relevant authorities that their specific requirements are being met.

# DAIRY FARM INFRASTRUCTURE: Practice Note Parts

**FDE FROM:**

-  Underpass
-  Farm dairy and yards
-  Feed pad

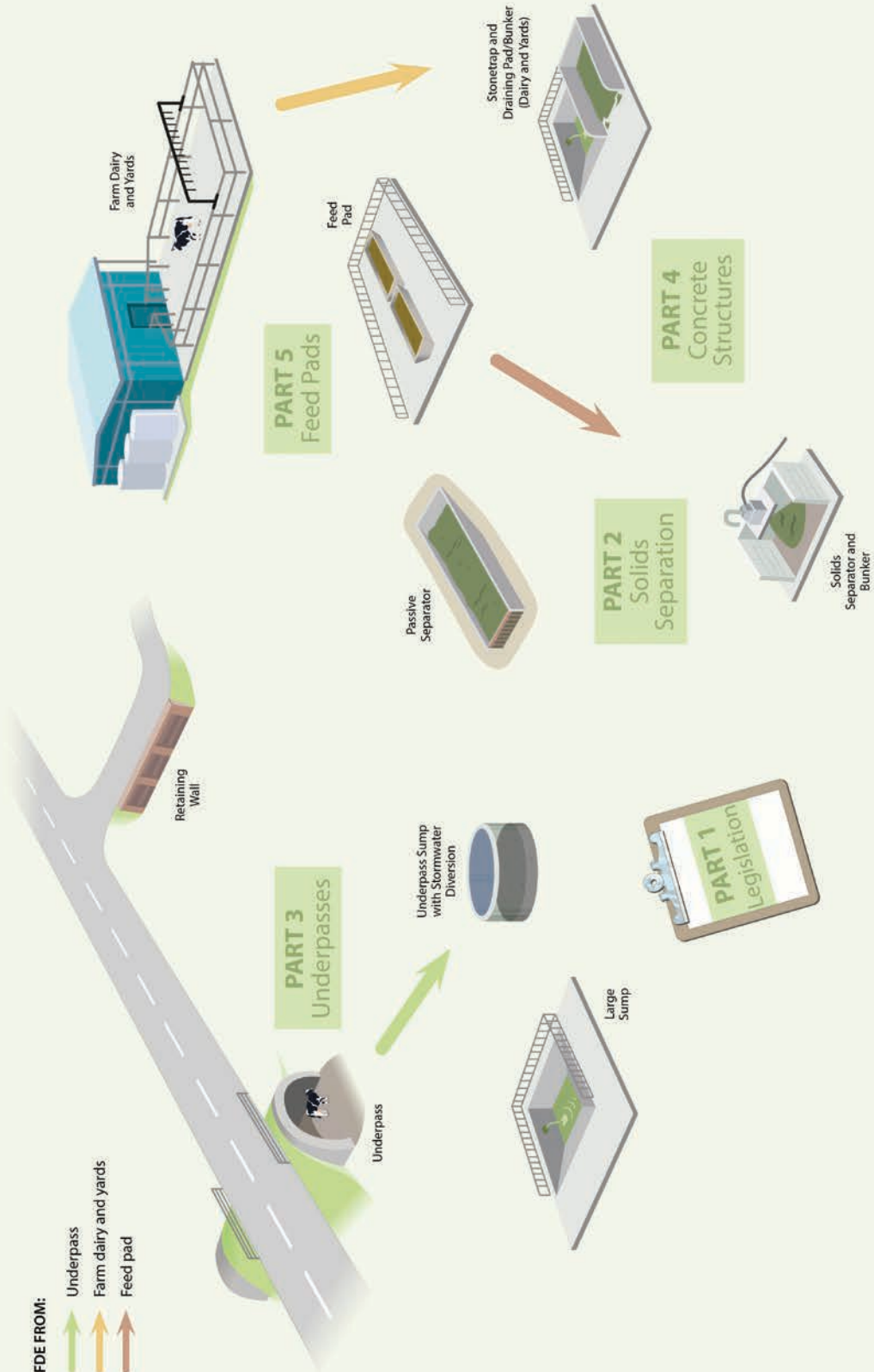

# CONTENTS

<b>PREFACE</b>	<b>I</b>		
<b>PRACTICE NOTE DEVELOPMENT</b>	<b>II</b>		
<b>CONTENTS</b>	<b>IV</b>		
<b>GLOSSARY</b>	<b>VIII</b>		
<b>PART 1: LEGISLATION</b>	<b>1</b>		
<b>1. INTRODUCTION</b>	<b>2</b>		
<b>2. HEALTH AND SAFETY AT WORK ACT (HSWA)</b>	<b>3</b>		
2.1 Duties	4		
2.1.1 Investigations	5		
2.1.2 The Building Act	5		
2.2 Identification of hazards	5		
2.3 Risk based approach	6		
2.4 Controlling risks	8		
2.5 Safety in design for farm infrastructure	10		
2.6 Hazard mitigation	12		
<b>3. RESOURCE MANAGEMENT ACT</b>	<b>14</b>		
3.1 Regional councils	14		
3.2 District councils	15		
<b>4. CONTAMINATED LAND</b>	<b>16</b>		
<b>5. HISTORIC PLACES ACT</b>	<b>17</b>		
<b>6. BUILDING ACT</b>	<b>18</b>		
6.1 Overview of the Building Act	18		
6.2 Building Code	19		
6.3 Building consents	20		
6.3.1 Producer statements	20		
6.4 Retaining walls	22		
6.5 Safety from falling	22		
6.6 Access	24		
6.6.1 Fixed platforms, walkways, stairways and ladders	25		
6.7 Building Code and industrial wastes	30		
<b>7. ANIMAL PRODUCTS ACT</b>	<b>31</b>		
<b>8. ANIMAL WELFARE ACT</b>	<b>33</b>		
8.1 Code of Welfare	33		
<b>PART 2: SOLIDS SEPARATION</b>	<b>35</b>		
<b>1. INTRODUCTION</b>	<b>36</b>		
<b>2. FDE SOLIDS</b>	<b>37</b>		
2.1 Nature of FDE solids	37		
2.2 General considerations	37		
2.2.1 Solids separation	37		
2.2.2 Application rates	38		
2.2.3 Solids as a resource	38		
2.3 When might solids removal not be appropriate?	38		
<b>3. SEPARATION METHODS</b>	<b>39</b>		
3.1 Anaerobic settlement ponds	39		
3.2 Sludge bed with weeping wall	40		
3.2.1 Sludge bed design	40		
3.2.2 Sludge bed operation	41		
3.2.3 Sludge bed volume calculations	41		
3.2.4 Sludge bed concept design	42		
3.2.5 Weeping wall design	44		
3.3 Scraped sludge bed with weeping wall	47		
3.3.1 Feedpad sludge bed design	47		
3.3.2 Scraped feed pad weeping wall design	47		
3.4 Primary screens	48		
3.4.1 Static sloping screens	49		
3.5 Inclined augers	50		
3.6 Horizontal screw press	50		
3.7 Rotating drum screen	52		

<b>4. SITING OF SEPARATION COMPONENTS</b>	<b>53</b>	<b>4. UNDERPASS STRUCTURE OPTIONS</b>	<b>76</b>
4.1 Mechanical and passive systems	53	4.1 Concrete	76
<b>5. SUPPORTING INFRASTRUCTURE</b>	<b>56</b>	4.2 Steel and aluminium structures	77
5.1 Floors, yard surfaces and races	56	4.2.1 Corrugated pipe	77
5.2 Effluent drains and sumps	57	4.2.2 Multiplate systems	77
5.3 Stone traps	57	4.3 Modification to an existing bridge	79
5.3.1 Stone trap design	58	4.4 General comments	79
5.4 Solids bunkers	59	<b>5. DESIGN</b>	<b>82</b>
<b>6. DESIGN CONSIDERATIONS</b>	<b>60</b>	5.1 Design introduction	82
6.1 Farm operations	60	5.2 NZTA Bridge Manual	82
6.2 Fail-safe and contingency	60	5.2.1 Roadside protection	84
6.3 Cost comparison	60	5.2.2 Settlement slabs	84
6.4 Use of screened FDE in pivot irrigators	61	5.3 Underpass sizing	84
6.5 Other technologies	61	5.4 Cow flow	85
<b>7. SUMMARY</b>	<b>62</b>	5.5 Ramps and aprons	86
<b>PART 3: UNDERPASSES</b>	<b>65</b>	5.6 Headwalls and wingwalls	86
<b>1. INTRODUCTION</b>	<b>66</b>	5.7 Drainage	87
<b>2. PRELIMINARY</b>	<b>67</b>	5.7.1 Ground water level	87
2.1 RCA requirements	67	5.7.2 Road surface water channels	87
2.2 Cost apportionments, agreements and ownership	68	5.7.3 Nib walls	88
2.2.1 Who pays?	68	5.8 Effluent management	88
2.2.2 Legal arrangements	68	5.8.1 FDE systems options	88
2.3 Programme	70	5.8.2 Stormwater diversion	91
2.4 Documentation	71	5.8.3 FDE storage calculation	92
2.5 Need for professional engineering guidance	72	5.8.4 Consents	92
<b>3. INVESTIGATIONS</b>	<b>73</b>	5.8.5 FDE systems references	92
3.1 Location	73	<b>6. CONSTRUCTION</b>	<b>93</b>
3.2 Survey	74	6.1 Inspections	93
3.3 Geotechnical investigation	74	6.2 Road corridor access	94
		6.3 Traffic management	94
		6.4 Construction issues	95
		6.4.1 Affected parties	95
		6.4.2 Safety	95
		6.4.3 Backfilling	95
		6.4.4 Groundwater pumping	96
		6.4.5 Joints	96
		6.4.6 Road surface sealing	96

<b>PART 4: CONCRETE STRUCTURES</b>	<b>97</b>	<b>6. MASONRY CONSTRUCTION</b>	<b>116</b>
<b>1. INTRODUCTION</b>	<b>98</b>	6.1 Masonry construction	116
1.1 Scope	98	6.2 Unreinforced masonry	116
<b>2. REGULATIONS FOR CONCRETE STRUCTURES</b>	<b>99</b>	6.3 Reinforced Masonry	116
2.1 Environmental regulations	99	6.4 Masonry wall versus precast concrete panel	118
2.2 Concrete standards	99	<b>7. CONCRETE STRUCTURES FOR THE FARM</b>	<b>119</b>
<b>3. SAFETY</b>	<b>101</b>	7.1 Retaining walls	119
3.1 Safety	101	7.1.1 Segmental retaining walls	120
<b>4. REQUIREMENTS FOR REINFORCED CONCRETE CONSTRUCTION</b>	<b>103</b>	7.2 Simple buildings	121
4.1 Durability	103	7.3 Storage structures	121
4.1.1 Specified intended life	104	7.4 Foundations	122
4.1.2 Factors affecting durability	105	7.5 Floor slabs	122
4.2 Functionality	108	7.6 Nib walls	123
4.2.1 Cracking	108	7.7 Surfacing	124
4.3 Compressive strength	108	7.7.1 Floor slopes	125
4.4 Specifying concrete	109	7.7.2 Slippery floors	125
4.4.1 NZRMCA Certificate of Audit	110	<b>8. STRUCTURAL ENGINEERING GUIDANCE</b>	<b>127</b>
4.5 Curing	110	<b>9. APPENDIX:</b>	<b>128</b>
4.5.1 Moisture control	110	9.1 CCANZ Information Bulletin: IB 55	128
4.5.2 Temperature control	111		
4.5.3 Strength development	111		
<b>5. REINFORCED CONCRETE DESIGN</b>	<b>112</b>		
5.1 Reinforced concrete	112		
5.1.1 Theory	112		
5.1.2 Structural design	112		
5.1.3 Reinforcement design	113		
5.2 Types of concrete	114		
5.3 Prestressed concrete	114		
5.4 Proprietary products	115		



<b>PART 5: FEED PADS</b>	<b>151</b>	<b>4. CONCRETE SLAB DESIGN</b>	<b>164</b>
<b>1. INTRODUCTION</b>	<b>152</b>	4.1 Slab design considerations	164
1.1 Scope	152	4.2 Design life	164
<b>2. DECISION MAKING</b>	<b>153</b>	4.3 Exposure and load conditions	164
2.1 Off pasture options	153	4.4 Concrete design – durability	165
2.1.1 Surfacing	155	4.4.1 Curing	166
2.2 Feed pads	155	4.5 Concrete design – loading	166
<b>3. GENERAL DESIGN</b>	<b>157</b>	4.6 Crack control	167
3.1 Regulatory	157	4.7 Reinforcement	169
3.1.1 Regional and district council rules	157	4.8 Damp proofing	169
3.1.2 Ministry for Primary Industries	157	4.9 Design guidance	170
3.2 Site selection	157	<b>5. CONCRETE CONSTRUCTION</b>	<b>171</b>
3.3 Site investigations	158	5.1 Site preparation	171
3.3.1 Survey	158	5.2 Concrete placement	172
3.3.2 Test pits	158	5.2.1 Concrete in hot and cold weather	172
3.4 Dimensions	158	5.2.2 Compaction	174
3.5 Orientation	159	5.2.3 Finishing	174
3.6 Surface slope	159	5.2.4 Curing	174
3.7 Covering	159	<b>6. EFFLUENT MANAGEMENT</b>	<b>176</b>
3.8 Drainage	160	6.1 Feed pad effluent	176
3.9 Access	160	6.2 Cleaning	178
3.10 Water supply	160	6.3 Greenwater reuse	180
3.11 Feeding facilities	160	6.4 Storage calculation	181
3.12 Feed storage	161	<b>REFERENCES</b>	<b>183</b>
3.12.1 Storage bunkers	161	Part 1: Legislation	183
3.12.2 Feed stacks	162	Part 2: Solids separation	186
		Part 3: Underpasses	187
		Part 4: Concrete structures	188
		Part 5: Feed pads	190
		<b>DISCLAIMER</b>	<b>191</b>
		<b>COPYRIGHT</b>	<b>192</b>

# GLOSSARY

<b>BA</b>	Building Act
<b>BCA</b>	Building Consent Authority
<b>CCANZ</b>	Cement and Concrete Association of New Zealand
<b>COPTTM</b>	Code of Practice for Temporary Traffic Management
<b>CPEng</b>	Chartered Professional Engineer
<b>DESC</b>	Dairy Effluent Storage Calculator
<b>DM</b>	Dry Matter
<b>FDE</b>	Farm Dairy Effluent
<b>HAIL</b>	Hazardous Activities and Industrial List
<b>HSE</b>	Health and Safety in Employment Act
<b>MBIE</b>	Ministry of Business, Innovation and Employment
<b>MPa</b>	MegaPascal
<b>MPI</b>	Ministry for Primary Industries
<b>NESCS</b>	National Environmental Standard for Assessing and Managing Contaminants in Soil to Protect Human Health
<b>NZBC</b>	NZ Building Code
<b>NZHPT</b>	NZ Historic Places Trust
<b>NZRMCA</b>	NZ Ready Mix Concrete Association
<b>NZS</b>	New Zealand Standard
<b>NZTA</b>	NZ Transport Agency
<b>PKE</b>	Palm Kernel Expeller
<b>RCA</b>	Road Controlling Authority
<b>RMA</b>	Resource Management Act
<b>RMP</b>	Risk Management Programme
<b>SCM</b>	Supplementary Cementitious Materials
<b>TLA</b>	Territorial Local Authority
<b>W/C</b>	Water/Cement Ratio

# PART 1

## **LEGISLATION**

---

# 1. INTRODUCTION

There are a number of legislative requirements that must be complied with when designing and constructing farm infrastructure. This Practice Note explores the most relevant of these associated with; solids separation, under-passes, concrete structures, and feed pads. It excludes specific reference to buildings and structures such as dairy sheds and houses, bridges and culverts. Farm Dairy Effluent (FDE) ponds are covered in IPENZ *Practice Note 21*.

In this Practice Note, legislation is used as a descriptive term that refers to all Acts, regulations and regulatory authority requirements as developed by parliament and governmental departments. It does not cover requirements of industry bodies.

The legislation referred to in this document is not intended as an exhaustive list and the reader will need to make their own inquiries as to whether other legislation will also be relevant for their proposed activity.

<b>Key Points</b>		
<b>Legislation</b>	<b>Possible Requirements</b>	<b>Regulatory Authority</b>
Health and Safety at Work Act 2015 (HSW Act)	Safety during construction Fencing of ponds Safe access	WorkSafe
Resource Management Act 1991 (RMA)	Resource Consent for construction/ earthworks (if trigger is exceeded) Resource consent for use/ discharge Consent for stream diversion	Regional council or unitary authority
Local government requirements (district plan/ RMA)	Land use consent Earthworks/gravel extraction	District council or unitary authority
Historic Places Act 1993 (HPA)	Archaeological authority application	New Zealand Historic Places Trust (NZHPT)
Building Act 2004 (BA); Building Code	Consent for construction Building consent for tank or bunker	District and regional council or unitary authority
Animal Products Act 1999	<i>NZCP1</i> : Code of Practice for design and operation of farm dairies	Ministry for Primary Industries (MPI)
Animal Welfare Act 1999	The Animal Welfare (Dairy Cattle) Code of Welfare 2010	Ministry for Primary Industries (MPI)

## 2. HEALTH AND SAFETY AT WORK ACT (HSWA)

The Health and Safety at Work Act 2015 (HSWA)<sup>1</sup> is New Zealand's workplace health and safety law. It introduces new responsibilities for managing the work-related risks that could cause serious injury, illness or even death. HSWA recognises that all parties need to work together to improve health and safety performance. Organisations and individuals all have a role to play in safe behaviours and managing these work-related risks.

HSWA provides a new way of thinking to ensure workers and others affected by the work-related activities are kept safe and their health is not compromised.

The Health and Safety at Work Act:

- Ensures everyone has a role to play
- Makes everyone's responsibilities clear
- Focuses on managing work risk
- Requires those who create the risk to manage the risk
- Requires businesses to engage with workers and enable them to actively participate in health and safety
- Allows flexibility in managing health and safety risks.

The full HSWA legislation and various quick reference guidelines are available online.

HSWA requirements relate to the whole life cycle of farm infrastructure. This spans from planning and design stages, to construction, on-going operation and future demolition or de-commissioning. Farm owners, contractors, designers, manufacturers and suppliers all have a role to play in identifying current and future hazards and managing the associated risks. This guideline section focusses on the first two stages of the health and safety risk management process.

*Figure 2.1: The HSWA risk management process*

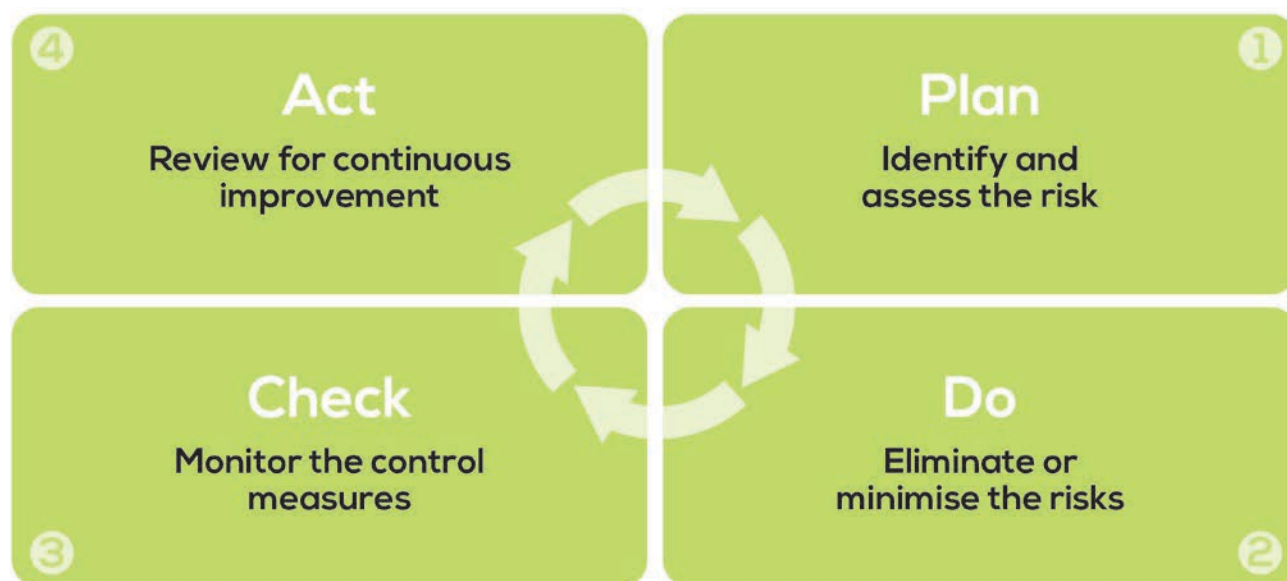

<sup>1</sup> [www.legislation.govt.nz/act/public/2015/0070/latest/whole.html#DLM5976667](http://www.legislation.govt.nz/act/public/2015/0070/latest/whole.html#DLM5976667)

There are a broad range of current and future hazards associated with farm infrastructure. Significant hazards may relate to:

- Safety around water
- Working at heights
- Electrical hazards
- Hazardous substances and wastes
- Working around livestock
- Confined spaces
- Moving plant and machinery
- Slips, trips and falls
- Lifting and manual handling.

A wide perspective is needed when identifying and managing the related risks.

## 2.1 DUTIES

*Table 2.1: Health and Safety Duties, Part 2 Health and Safety at Work Act 2015*

- (1) A duty imposed on a person by or under this Act requires the person –
- (i) to eliminate risks to health and safety, so far as is reasonably practicable; and
  - (ii) if it is not reasonably practicable to eliminate risks to health and safety, to minimise those risks so far as is reasonably practicable.
- (2) A person must comply with subsection (1) to the extent to which the person has, or would reasonably be expected to have, the ability to influence and control the matter to which the risks relate.

The design, manufacture, supply and installation of farm infrastructure are “upstream” activities. Upstream businesses and individuals are responsible for ensuring that the products and services they provide downstream do not create health and safety risks.

Providers of planning, design and construction services are in a strong position to eliminate or minimise risks to health and safety by taking a preventative approach prior to infrastructure being built.

For example, the designer of a farm building roof using a high pitch and putting in secure anchor points because they have thought ahead to how the cleaning and repair of the roof might be carried out.

Many duties under HSWA apply ‘so far as is reasonably practicable’. It’s an important concept that involves doing what is reasonably able to be done to ensure people’s health and safety under the given circumstances.

Something is ‘practicable’ if it is possible or capable of being done. ‘Reasonably’ doesn’t mean doing everything humanly possible to manage a risk. It means doing what other businesses would reasonably do in the same situation. A risk-based approach is required generally following the steps below:

- Identify the health and safety risks (hazards) – particularly those that have the potential to cause serious injury or illness
- The likelihood of those risks occurring
- The degree of harm that could result from those risks
- The options to eliminate the risks
- The options to minimise the risks (where they can’t be eliminated)
- The associated costs.

Consideration of cost should only take precedence over safety when it is grossly disproportionate to the risk.

## 2.1.1 Investigations

Investigations into breaches of the HSWA are carried out by WorkSafe NZ and may lead to enforcement activities when it is necessary to:

- Ensure immediate action by duty holder(s) to protect people and the environment from immediate risks of harm,
- obtain compliance with the law, and
- hold to account those that have breached the law.

## 2.1.2 The Building Act

Meeting Building Act (BA) requirements assists with meeting HSWA requirements but not all HSWA requirements can be satisfied by complying with the BA.

## 2.2 IDENTIFICATION OF HAZARDS

Hazards should be identified as the first step in the risk based approach. Hazards are those things that might happen (or the things that could wrong) that will cause harm. It can be useful to take the mind-set of “what if...?”.

*Figure 2.2: Hazard to Risk diagram*

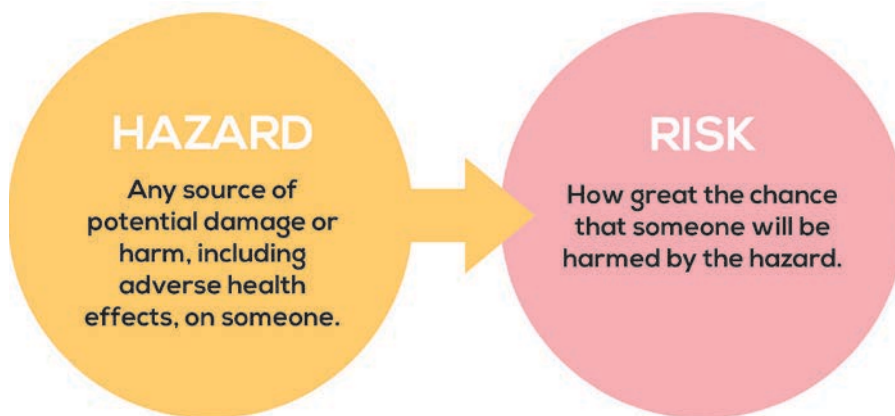

The purpose of hazard identification is to come up with an exhaustive list of hazards. This requires time and effort to think of all hazard sources, trying to approach the problem from as many different angles as possible. Hazard identification benefits from involving multiple people to get a wider perspective and a more exhaustive list.

It's not important at this stage to concentrate on how severe each hazard is, the focus is on adding any relevant hazards to the list.

The context of the hazards should relate to the whole life of the farm infrastructure. Particular attention should be given to how the following activities, people and processes:

- Handling
- Storage
- Construction
- Operation
- Cleaning, maintenance and repair
- Exposure of people in the vicinity
- Eventual demolition and disposal
- Natural disasters.

For any site the list of hazards should be an open and live document. Any time a new hazard is identified it should be added to the list. An example register for the installation of a culvert on a farm is shown in Table 2.2. For the same example a risk assessment is given in Table 2.4 and some control measures in Table 2.5.

*Table 2.2: Hazard Identification Register*

What can cause harm to me/others? (e.g. For the installation of a culvert)
Falling from the top of the culvert
Flooding from culvert blockage
Livestock falls into waterway
Slipping during maintenance, or moving of side slopes due to steep grades
Vehicle accident due to culvert crossing approaches with sharp bends
Unsafe to maintaining the waterway under the culvert due to low headroom

[Saferfarms.org.nz](http://Saferfarms.org.nz) produce guides<sup>2</sup> and fact sheets<sup>3</sup> covering relevant topics identifying common hazards for farms and suggesting appropriate controls.

## 2.3 RISK BASED APPROACH

Once the hazards have been identified the level of associated risk needs to be determined. A risk assessment takes into consideration factors such as the frequency of exposure to the hazard, the likelihood of harm, and past history of incidents involving that hazard. It also considers the severity of the most likely degree of harm – an important distinction, as many hazards “could” prove fatal, but their most likely consequence is often something less serious. To keep hazard management practical, it must be based on realistic risk assessments – how often is it likely to happen, and what is the most likely consequence?

The risk formula is:

$$\text{Risk} = \text{Likelihood} \times \text{Consequence}$$

<sup>2</sup> [www.saferfarms.org.nz/guides](http://www.saferfarms.org.nz/guides)

<sup>3</sup> [www.saferfarms.org.nz/fact-sheets](http://www.saferfarms.org.nz/fact-sheets)



An established method for quantifying risk is the risk matrix. For each hazard the risk is assessed based on a 1 – 5 scale of likelihood and a 1 – 5 scale of consequence. The 5 x 5 risk matrix as illustrated in Figure 2.3 is:

*Table 2.3: 5 x 5 Risk Matrix*

			Potential Consequence of Hazards				
			1	2	3	4	5
			Insignificant	Minor	Moderate	Major	Catastrophic
Likelihood	V	Almost certain	Low	Medium	High	Extreme	Extreme
	IV	Likely	Low	Medium	High	Extreme	Extreme
	III	Possible	Low	Medium	Medium	High	Extreme
	II	Unlikely	Low	Low	Medium	High	High
	I	Rare	Low	Low	Low	Medium	High

Where the definition of the consequence of the threats are:

<b>Insignificant</b>	No harm incidents
<b>Minor</b>	First aid treatment for one or more people
<b>Moderate</b>	Medical treatment injury to one or more people
<b>Major</b>	Serious harm injury to one person
<b>Catastrophic</b>	Death or multiple serious harm injuries

For the culvert installation example, the risks assessment could look like Table 2.4:

Table 2.4: Risk Assessment

What can cause harm? (e.g. For the installation of a culvert)	Likelihood	Consequence	Risk
Falling from the top of the culvert	Possible	Major	High
Flooding from culvert blockage	Unlikely	Minor	Low
Livestock falls into waterway	Likely	Minor	Medium
Slipping during maintenance, or moving of side slopes due to steep grades	Possible	Major	High
Vehicle accident due to culvert crossing approaches with sharp bends	Possible	Major	High
Trapped while maintaining the waterway under the culvert due to low headroom	Unlikely	Moderate	Medium

## 2.4 CONTROLLING RISKS

Once you’ve assessed the risks you need to decide how you will deal with them. Consider first whether the risk can be eliminated (e.g. can you remove the source of the harm?). If the risk can’t be eliminated, then it must be minimised using control measures. The higher the risk, the more extensive the control measures need to be. The most effective control measures are at the top of the hierarchy shown in Figure 2.3.

Figure 2.3: Hierarchy of Controls

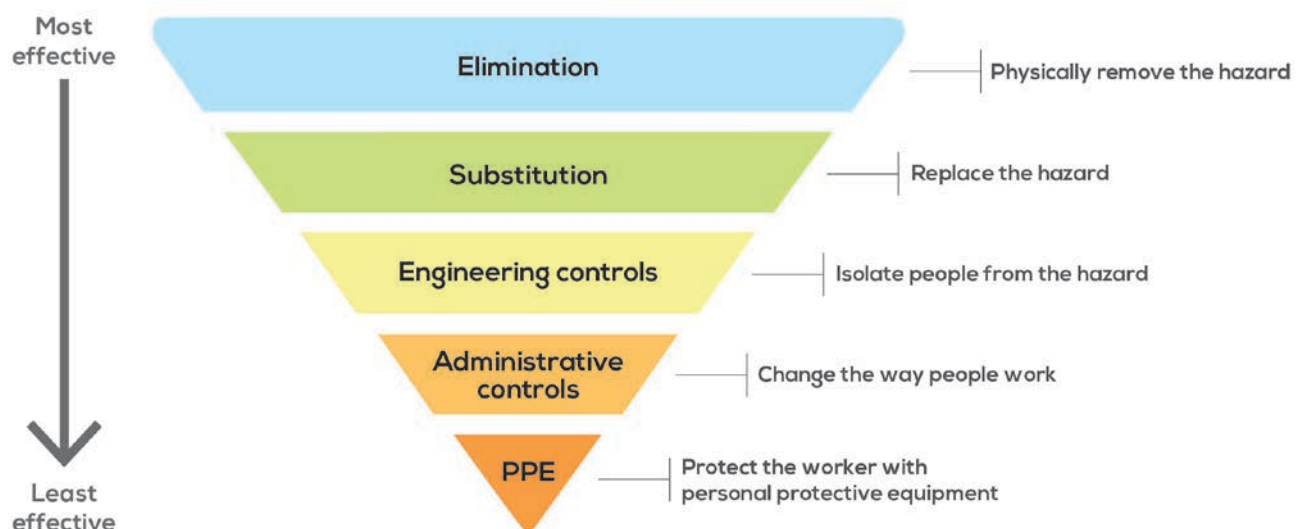

Elimination is the most effective way of reducing risk and the use of personal protective equipment (PPE) is the least effective.

Think about the current control measures in place, and whether they are managing the risk. If not:

- Find out if there are any legal requirements relevant to the risk, and if there are any standards or guidance materials you could follow. For example, preventing falls from heights
- Ask others who do similar work to you how they manage the risk
- Seek specialist advice from a competent health and safety professional
- Think about easy and accessible ways to control the risk and whether they will be followed
- Think about whether the controls you implement could create other risks
- The most expensive control option is not necessarily the best one. If there are well-known and effective controls for farm infrastructure already in use, consider if they are suitable and implement them
- Engage with the other people affected by the risks about the ways to eliminate or minimise
- Communicate the risks and the control measures in a way that is appropriate to the needs of people affected later in the life cycle of the infrastructure (i.e. appropriate to the way they work, their work environment and their literacy and language)
- Remember that good health and safety is not about good paperwork, it is about active control of risk.

The control measures can be added to the risk matrix to show how each risk has been actively managed. With the control measures in place, the remaining risk for each hazard should be identified as the “residual risk”. For the culvert example this is shown in Table 2.5.

*Table 2.5: Risk Assessment with Control Measures*

<b>What can cause harm to me/others? (e.g. For the installation of a culvert)</b>	<b>Original Risk</b>	<b>Control measure</b>	<b>Residual Risk</b>
Falling from the top of the culvert	High	Install barriers and handrails either side of culvert crossing to prevent falls [Engineering controls]	Medium
Flooding from culvert blockage	Low	Design the culvert opening large enough to be sufficient for high storm flows [Engineering controls]	Low
Livestock falling into waterway	Medium	Provide stock fencing and separation planting [Engineering controls]	Low
Slipping during maintenance, or movement of side slopes due to steep grades	High	Install concrete or stone apron either side of wingwall to remove maintenance requirement [Substitution]  Mow or trim around edges [Administration controls]	Low
Vehicle accident due to culvert crossing approaches with sharp bends	High	Design sufficiently wide and straight culvert vehicle approaches [Engineering controls]  Culvert barriers help reduce consequence of vehicle accident [Engineering controls]	Medium
Trapped while maintaining the waterway under the culvert due to low headroom	Medium	Design height of waterway passage under culvert to allow full standing headroom. [Engineering controls]	Low

## 2.5 SAFETY IN DESIGN FOR FARM INFRASTRUCTURE

Safe design begins in the concept and planning phases by considering materials used and methods of manufacture or construction to enhance the safety of the finished product. Opportunities to prevent future harm are most cost effective when captured in the earliest phases of the lifecycle. The most effective risk control measure – eliminating the hazard – is often cheaper and more practical to achieve at the design or planning stage, rather than making changes later in the lifecycle when the hazards become material risks. The designer needs to consider how safety can best be achieved in each of the lifecycle phases, for example:

- Designing a machine with protective guarding that will enable safe operation, while also ensuring that the machine can be installed, maintained and disposed of safely
- Designing a raised platform for workers with barriers to prevent falling and sufficient room for movements and handling to be done safely.

Figure 2.4: Safety Lifecycle



A specific example of the safety in design thought process is presented in Table 2.6 as an aid for farm infrastructure designers.

Table 2.6: Example Safety in Design table for an effluent pump station

Generic Keywords & Questions	Identified Future Hazards	How is Hazard Mitigated in Design
<b>Size/Position:</b> can these be modified to improve safety?	Not enough space between pump station and treeline for tree maintenance activities	Location moved away from treeline to provide sufficient space
<b>Ergonomics:</b> posture, discomfort, slips and trips, repetitive use	Heavy chambers lid not able to be easily opened when bending over	Use multiple lighter lids or different material lid for ease of opening
<b>Use:</b> how safe are people using it during all phases of operation?	Electric shock during routine checking of the equipment	Controls for the pump located in a shed to allow routine checks to be done in a controlled environment
<b>Misuse/failure:</b> How could it be misused or fail?	The pump fails and effluent builds up and spills into nearby creek	Install a backup pump or alarm system and design a secondary flow path in the case of effluent spilling out
<b>Construction:</b> what are the risks specific to the construction phase?	Prefabricated units too heavy or unsafe to install with available machinery	Design structures with smaller units that can be safely transported and installed on site
<b>Environmental Conditions:</b> what's the effect on the environment and how will weather/disasters affect safety?	Floods affect the station and allow effluent to be washed along ground surface	Design the top height of the chamber to be above typical flood level to prevent water getting in
<b>Access:</b> can it be accessed safely by workers, and is access restricted to public, farm visitors, children, wandering animals?	Unauthorised access to mechanical and electrical equipment	Install a permanent fence around the station with a warning sign attached
<b>Maintenance/Repair:</b> how is it cleaned, maintained and repaired safely?	Unsafe to enter confined spaces to retrieve pump for maintenance	Provide a lifting chain or rail so the pump can be retrieved from a safe position
<b>Demolition/Disposal:</b> how is it demolished or disposed of?	Exposure to contaminated materials when disposing items	Provide isolation valves so that pumps and pipework can be removed safely without effluent spill

## 2.6 HAZARD MITIGATION

Regardless of how large the farm infrastructure component is, it is strongly recommended that system designers have Health and Safety related features designed and incorporated into their designs.

There needs to be effective communication with farm staff, contractors and visitors about hazards on the farm.

The appropriate type and extent of mitigation required for each farm will vary and be dependent on the hazard risks identified for each component part.

Where a site contains hazards, which might attract the unauthorized or unexpected entry of the public, children, or wandering animals (both small and large), then the hazard needs to be enclosed to restrict access.

*Table 2.7: Examples of Hazard Mitigation Features for Farms*

Mitigation Feature	Method of Hazard Mitigation (During both construction and operation)
Operation manuals	Written instructions on safe equipment operation
Fencing	Permanent and secure fencing to prevent stock, children, and unauthorised access
Secured access	Lockable access points to gates, lids and covers, ladders and platforms
Escape ladders	Permanent ladders or alternative means of escape from ponds and tanks
Safe access	Ladders, platforms, barriers where there is a falling-from-height risk
Signage	Hazards on site clearly shown



Solids separation processes introduce a specific set of potential hazards to the farm dairy environment. The designer needs to consider these and ensure measures are in place to eliminate, isolate or minimise them. Specific considerations are included in Table 2.8.

Table 2.8: Health and Safety: Some Potential Hazards Around Farms

<b>Stone Traps</b>
<ul style="list-style-type: none"> <li>• Provide roughened surface that will allow good traction for tractor to reverse out</li> <li>• Install fall protection barrier, for example removable gates, or pipe and rail fence to clearly delineate trap. Material in wedge-style traps can form a crust which may appear firm but is not</li> <li>• Consider covers to the trap.</li> </ul>
<b>Pump Sumps</b>
<ul style="list-style-type: none"> <li>• These are particularly dangerous, being deep and containing pontoons and mixing machines</li> <li>• Provide secure child-proof fencing with self-latching gate</li> <li>• Pontoons must be able to support service personnel safely without danger of tipping.</li> </ul>
<b>Mechanical Separators</b>
<ul style="list-style-type: none"> <li>• Any machinery such as screw presses or rotating drums needs appropriate protection (for example guards) and warning of any moving parts; this should be part of the machine design</li> <li>• Provide an isolating switch at the solids bunker so the machine can be easily disconnected for any servicing.</li> </ul>
<b>Safety Platforms</b>
<ul style="list-style-type: none"> <li>• All separators (whether static screens or screw press/drums) mounted at height on solids bunkers must have a specifically designed working platform with secure ladder access to provide safe access for servicing. It is not acceptable practice to require farm staff to balance on narrow concrete walls or the machine frame at an unsafe height above a concrete surface to clean or service a machine</li> <li>• Platforms need to be professionally designed appropriate to the service loadings and sufficiently rigid to not vibrate with the action of the machine or pumps, and constructed from galvanised steel or other durable materials.</li> </ul>
<b>Sludge Beds, Weeping Walls and Anaerobic Ponds</b>
<ul style="list-style-type: none"> <li>• Any storage for liquid whole manure will form a crust within a few days as organic matter decomposes and rises to the surface. In time this will grow weeds, but underneath will still be liquid or thin sludge and will not support the weight of a person. Such storages need to be well fenced and signed. As a minimum, fencing should be netting with a hot wire on top to discourage climbing over, and a secure self-latching gate. Deer height fencing is preferable, again with a hot wire on top.</li> </ul>
<b>Children Around Farm Dairies</b>
<ul style="list-style-type: none"> <li>• Farm dairies are hazardous areas and children should not be in the area unsupervised. Careful consideration, in close consultation with the farm owner, needs to be given to the risk posed by farm effluent system components and how best to minimise hazards.</li> </ul>



*Slope screen with platform and safety railing, access ladder at rear*

## 3. RESOURCE MANAGEMENT ACT

The Resource Management Act 1991 (RMA) contains various duties and restrictions in relation to the use of land and water, and to the discharge of contaminants into the environment. It provides a legislative framework, under which regional and district councils are responsible for achieving sustainable management within their geographical area. Primarily this is achieved through regulations as part of regional and district plans.

Many farming activities are permitted activities and do not need to be covered by specific resource consents. If in doubt regarding any matter relating to resource consent requirements, the relevant regional or district council, or a resource management professional should be contacted.

### 3.1 REGIONAL COUNCILS

Regional councils in New Zealand, broadly speaking, manage natural resources, including lakes, rivers, air, coastal and soil resources. There are also five unitary authorities in New Zealand, who play both the role of regional council and district council.

To undertake infrastructure development, resource consents are required by some councils for effluent ponds and irrigation ponds to ensure that the integrity of the design and construction avoids seepage into the environment. Most councils stipulate requirements for the discharge of FDE to land. Resource consents are also generally required for works within waterways, such as the development of farm bridges or large culverts and may depend on the size of the catchment.

While a resource consent may not be required for the development of other farm infrastructure, it may be required for their operation. This includes taking water for irrigation or discharging dairy effluent.

If the development or operation of farm infrastructure may affect neighbouring properties, it is good practice to consult with these parties and advise them of your intentions. In many cases, you may also be required to gain written approval from these parties (owners and occupiers) as part of your resource consent application. Your regional council will be able to confirm this, and recommend any further consultation with other parties such as iwi or Fish & Game New Zealand.

DairyNZ offers a very useful effluent compliance checklist on their website.

*Table 3.1: Regional Council Requirements – Issues for farm owners*

Regional Council Requirements – Issues for farm owners
<ul style="list-style-type: none"> <li>• What regional plan rules are applicable to the development and/or operation of farm infrastructure?</li> <li>• Is the activity a permitted activity and what is needed to comply with this permitted activity?</li> <li>• Is resource consent/s required?</li> <li>• What information do I need to provide as part of the resource consent application?</li> <li>• Do I need any technical reports to support my resource consent application?</li> <li>• Who do I need to consult with and seek written approval from?</li> </ul>



## 3.2 DISTRICT COUNCILS

District and city councils in New Zealand, broadly speaking control the use, development and protection of land and how the uses can affect the environment.

Generally, one district plan is produced for each district or city council. Like regional plans, each district plan must contain objectives for the district, policies to implement these objectives and rules to implement the policies. They may include other matters such as non-regulatory methods and environmental results expected.

The construction and operation of FDE ponds is frequently, but not always, a permitted activity by district councils, whether specifically or by default. Separation distances from roads, houses or property boundaries are often specified, and these can be different from, that is greater than, the separations required by regional councils. When considering the construction of FDE ponds, not only should the activity itself be assessed against the district plan with regards to location, distance and storage volume, it will also be necessary to ensure that the earthworks required for construction are also authorised.

If the development or operation of farm infrastructure may affect neighbouring properties, it is good practice to consult with these parties and advise them of intentions. In many cases, you may also be required to gain written approval from these parties (owners and occupiers) as part of your resource consent application. The district council will be able to confirm this, along with whether consultation is recommended with other parties such as iwi or Fish & Game New Zealand.

*Table 3.2: District Council Requirements – Issues for farm owners*

### District Council Requirements – Issues for Farm owners

- What zone is the farm located in and what are the requirements for the zone? For example, rural, coastal or urban?
- Is resource consent/s required for the development and/or operation of farm infrastructure?
- Have I checked the district plan planning maps for any special features that may be located on my farm, for example significant landscape area or flood zone?
- What information do I need to provide as part of the resource consent application?
- Do I need any technical reports to support my resource consent application?
- Who, if anyone, do I need to consult with and seek written approval from for my resource consent application?

## 4. CONTAMINATED LAND

---

The Hazardous Activities and Industries List (HAIL) is a compilation of activities and industries that are considered likely to cause land contamination resulting from hazardous substance use, storage or disposal. The intention of HAIL is to highlight situations where hazardous substances could cause, or have caused, land contamination.

The National Environmental Standard for Assessing and Managing Contaminants in Soil to Protect Human Health (NESCS) came into effect on 1 January 2012. It ensures that land affected by contaminants in soil is appropriately identified and assessed before it is developed and if necessary remediated or contaminants contained to ensure the area is safe for human use.

Farm land is not exempt from such contamination. The land could have been contaminated in the past from, such as from, historical sheep dips, pesticide storage, mineral extraction, or timber processing facilities. New farm infrastructure could be caught by a previous use activity and so a search of local HAIL records is always recommended at the project feasibility stage.

Note that the regulations of the NESCS apply to land if it's used, or has been used, or is more likely than not to have been used, for one of the activities or industries listed on the HAIL which are considered likely to cause land contamination. The HAIL can be found on the Ministry for the Environment's website or at the local council.

If a change in land use and/or disturbance to land that is identified on the HAIL is proposed, it will need to be considered whether a resource consent will be required under the NESCS.

The NESCS classifies small scale (no more than 25 cubic metres per 500 m<sup>2</sup> of affected land) and temporary soil disturbance activities (no more than two months' duration) as permitted activities. Any earthworks exceeding this will need to be assessed further to determine if resource consent is required under the NESCS.

## 5. HISTORIC PLACES ACT

The Historic Places Act 1993 (HPA) makes it unlawful to destroy, damage or modify an archaeological site without the prior authority of the New Zealand Historic Places Trust (NZHPT). This is the case regardless of whether a resource consent or building consent has been granted.

District plan planning maps can include heritage and archaeological sites. These should be checked prior to consent applications being submitted for the development of farm infrastructure. If you wish to do any work that may affect an archaeological site, you must obtain an authority from the NZHPT before you begin. This may include associated earthworks or excavation activities. If you uncover a previously unknown site during earthworks, you may also need permission to continue. For further information on investigating archaeological sites contact NZHPT<sup>4</sup>.

Figure 5.1: Excerpt from NZHPT Brochure, *Applying for an Archaeological Authority*

### WHEN DO I NEED AN ARCHAEOLOGICAL AUTHORITY?

If you are going to do work that may affect an archaeological site you must obtain an archaeological authority from the New Zealand Historic Places Trust before you start work. This could be earthworks for subdivision, forestry operations, mining, road construction, building, landscaping or fencing.

### HOW DO I APPLY FOR AN ARCHAEOLOGICAL AUTHORITY?

You need to fill out an application form. To obtain a copy, contact your local Trust office (see overleaf) or visit the website [www.historic.org.nz](http://www.historic.org.nz). The Trust will consider your application and advise you in writing of its decision.



### WHAT INFORMATION DO I NEED TO APPLY?

- ▶ A description of the activity that will affect the site.
- ▶ A description of the archaeological site.
- ▶ An assessment of the archaeological values of the site and the effect of the work on those values. You may need to engage an archaeologist or cultural heritage specialist to describe the site and undertake this assessment. To obtain a list of consultant archaeologists, contact the NZ Archaeological Association.
- ▶ An assessment of any Maori values of the site and the effect of the work on those values. This assessment is best provided by tangata whenua. The Trust can assist with contacts.
- ▶ A statement about consultation. If you have consulted with tangata whenua or other affected people, what are their views? If you have not consulted, you must inform the Trust of the reasons why consultation has not taken place.
- ▶ The consent of the landowner (if the landowner is not the applicant).

If this information has already been prepared for a resource consent application, it may be able to be reused.

### HOW LONG DOES THE PROCESS TAKE?

Once the Trust has received a completed application, a decision is usually made within four to six weeks. The Trust must make a decision within three months.

### WHAT HAPPENS WHEN I RECEIVE MY AUTHORITY?

If the Trust decides to grant an authority, some mitigation may be required for the loss of or damage to the site. This may involve an archaeologist monitoring the work that affects the site and recording any information, or an archaeological investigation of the site.

### WHO WILL DO THE ARCHAEOLOGICAL WORK REQUIRED?

The Trust must approve in writing any person who will carry out the archaeological work. It is useful to nominate this person when you apply for your authority.

### HOW LONG IS THE AUTHORITY VALID?

Authorities are non-transferable and expire five years after the date of issue. If you have not completed the work within this period, you will need to reapply.

<sup>4</sup> [www.heritage.org.nz/about-us/offices](http://www.heritage.org.nz/about-us/offices)

## 6. BUILDING ACT

### 6.1 OVERVIEW OF THE BUILDING ACT

Different types of farm infrastructure can be subject to the Building Act 2004 (BA). Building structures such as covered yards, bunkers, raised platforms, retaining walls, stock underpasses and ancillary buildings can be subject to the BA. Mechanical, electrical and other systems are also captured by the Act. It is therefore important for the farm infrastructure designer to have some understanding of the BA relating to building regulation and consent requirements.

The scope of the BA also includes structures for containing water, FDE or other fluids such as tanks, sumps, pits, dams, ponds as well as their appurtenant (associated) structures. This Practice Note does not specifically include building legislation commentary for FDE tanks and ponds; this is covered in *Practice Note 21*, Part 1 section 3.

The definition of a building (as shown in Table 6.1) is very broad and would include almost all farm structures. There is no differentiation in the legislative requirements between rural and urban environments (except for certain aspects of retaining walls).

*Table 6.1: Excerpt of Building Act (2004) Part 1 Preliminary provisions, Subpart 1 – General, Meaning of Building*

**Building: what it means and includes**

8 (1)

- (a) means a temporary or permanent movable or immovable structure (including a structure intended for occupation by people, animals, machinery, or chattels)
- (b) includes –
  - (i) a mechanical, electrical, or other system
- (c) includes any 2 or more buildings that, on completion of building work, are intended to be managed as one building with a common use and a common set of ownership arrangements

Building work as defined in the BA in Table 6.2 includes site work which is unable to be started until a building consent is issued.

*Table 6.2: Excerpt of Building Act (2004) Subpart 2 – 7 Interpretation*

**building work**

- (a) means work –
  - (i) for, or in connection with, the construction, alteration, demolition, or removal of a building
- (b) includes sitework;
- (c) includes design work (relating to building work)

Two important BA sections need to be considered when any structure is constructed or altered.

Section 7 states that building work includes “site work” and “design work relating to building work”. Therefore, in general terms no site work can be started until a Building Consent (if not exempted) has been approved for the proposed construction.

Section 17 states “All building work must comply with the Building Code to the extent required by this Act, whether or not a Building Consent is required in respect of that building work”. Therefore, regardless of the DC and RC requirement for (or not for) Building Consents, there is still a requirement for structures to meet the performance requirements of the Building Code.

## 6.2 BUILDING CODE

Sitting under the Building Act in the New Zealand regulatory framework is the Building Regulations Act which sets out clear expectations of the standards that buildings should meet. Contained in Schedule 1 is the NZ Building Code (the Code). It covers aspects such as structural stability, fire safety, access, moisture control, durability, services and facilities, and energy efficiency.

The Code states how a building must perform in its intended use, rather than describing how the building must be designed and constructed. In other words, it is a performance-based Building Code.

The Code consists of three general clauses and a number of technical clauses.

Within each technical clause, the requirements are explained in three levels:

1. Objective – social objectives from the Building Act
2. Functional requirement – functions the building must perform to meet the Objective
3. Performance – the performance criteria the building must achieve. By meeting the performance criteria, the Objective and Functional requirement can be achieved.

*Figure 6.1: New Zealand Regulatory Framework for Buildings  
(Source – MBIE, New Zealand Building Code Handbook, section 2.3)*

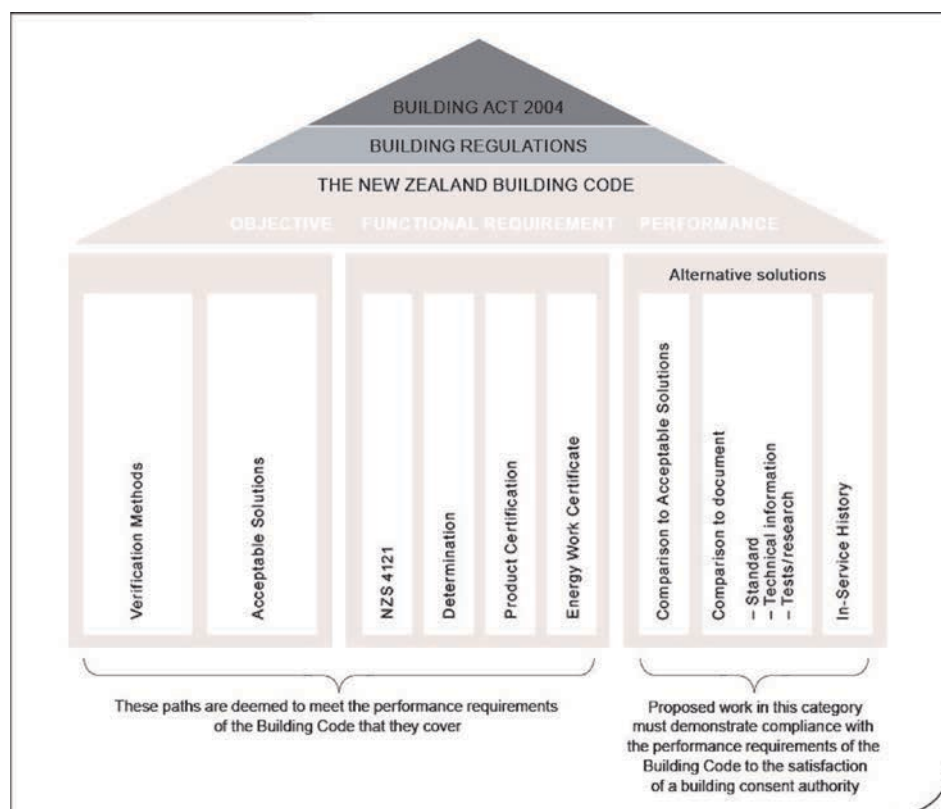

### Acceptable Solutions, Verification Methods and Alternative Solutions

Building Code compliance can be demonstrated through different means. One means of demonstrating compliance is to follow an Acceptable Solution or Verification Method. MBIE publishes Acceptable Solutions and Verification Methods, but it is not mandatory to use them.

- Acceptable Solutions (AS) – specific construction methods, some for simple residential buildings, that when followed are deemed to comply with the Building Code
- Verification Methods (VM) – methods of testing, calculations and measurements that when followed are deemed to comply with the Building Code.

Acceptable Solutions and Verification Methods provide information about materials, construction details, and calculation methods. If followed, they must be accepted by a BCA as complying with the related Building Code provisions.

An Alternative Solution is a building solution that differs from the solutions offered by the AS or VM but achieves compliance with the performance requirements of the Code to the satisfaction of the BCA.

There may be a number of reasons for the use of an alternative solution:

- There may not be an AS or VM for the proposed construction
- The building work may incorporate unusual design features that fall outside the scope of an AS or VM.

Whatever the reason for using an alternative solution, the Code, being performance based, allows for innovation and applicants have the freedom to propose an innovative solution.

## 6.3 BUILDING CONSENTS

All building work in New Zealand must comply with the Building Code, even if it doesn't require a building consent. This ensures buildings are safe, healthy and durable for everyone who may use them. Plans and specifications are assessed by building consent authorities (BCAs), usually a district or city council, to ensure the proposed building work will comply with the Code. Regional councils are also responsible for all building consents for dams and other related functions under the Building Act.

When the BCA is satisfied, it will issue a building consent for the work to proceed. If the work is built to the consented plans and receives a code compliance certificate, it confirms the requirements of the Code have been met.

The Act under Part 1 Exempted building work – General, allows authorities some discretion as to whether a building consent is not necessary.

*Table 6.3 Excerpt from the Building Act (2004), Part 1 Exempted building work, General*

### **2 Territorial and regional authority discretionary exemptions**

Any building work in respect of which the territorial authority or regional authority considers that a building consent is not necessary for the purposes of this Act because the authority considers that –

- (i) the completed building work is likely to comply with the Building Code; or
- (ii) if the completed building work does not comply with the Building Code, it is unlikely to endanger people or any building, whether on the same land or on other property.

When this Practice Note was being developed, it became apparent that some building regulations are intended to relate to rural buildings and structures, including tanks and ponds, but are not as clearly expressed and understood as they could be.

Clarification should therefore be sought from the appropriate BCA at an early stage in a project's development as to whether a building consent is required.

### **6.3.1 Producer statements**

Chartered Professional Engineers carrying out design or construction monitoring submit Producer Statements (PS's) to confirm their professional opinion that aspects of a building's design comply with the Building Code, or that elements of construction have been completed in accordance with the approved building consent.

Further, and to give farm owners confidence that contractors have completed their construction works in accordance with contract requirements, a standard form such as NZS 3910:2013 *Schedule 6 – Form of Producer statement – Construction* is often used for this purpose, and is colloquially referred to as a “PS3 (Construction)”.

For the certification of the design and construction of building structures, including tanks, ponds, or dams, IPENZ members (only) should submit IPENZ Producer Statements whether required for a Building Consent, or simply to establish Building Code compliance where consent was not required. These statements will be appropriate whether the BCA is the Regional or District Council.

Compliance with the Building Code for any item of farm infrastructure is the responsibility of the farm owner/client, enabled by the designer and person carrying out construction monitoring.

Figure 6.2: A Guide to Resource and Building and Consent Process  
(Source: MBIE – A beginner’s guide to resource and building consent processes)

### A beginner’s guide to resource and building consent processes

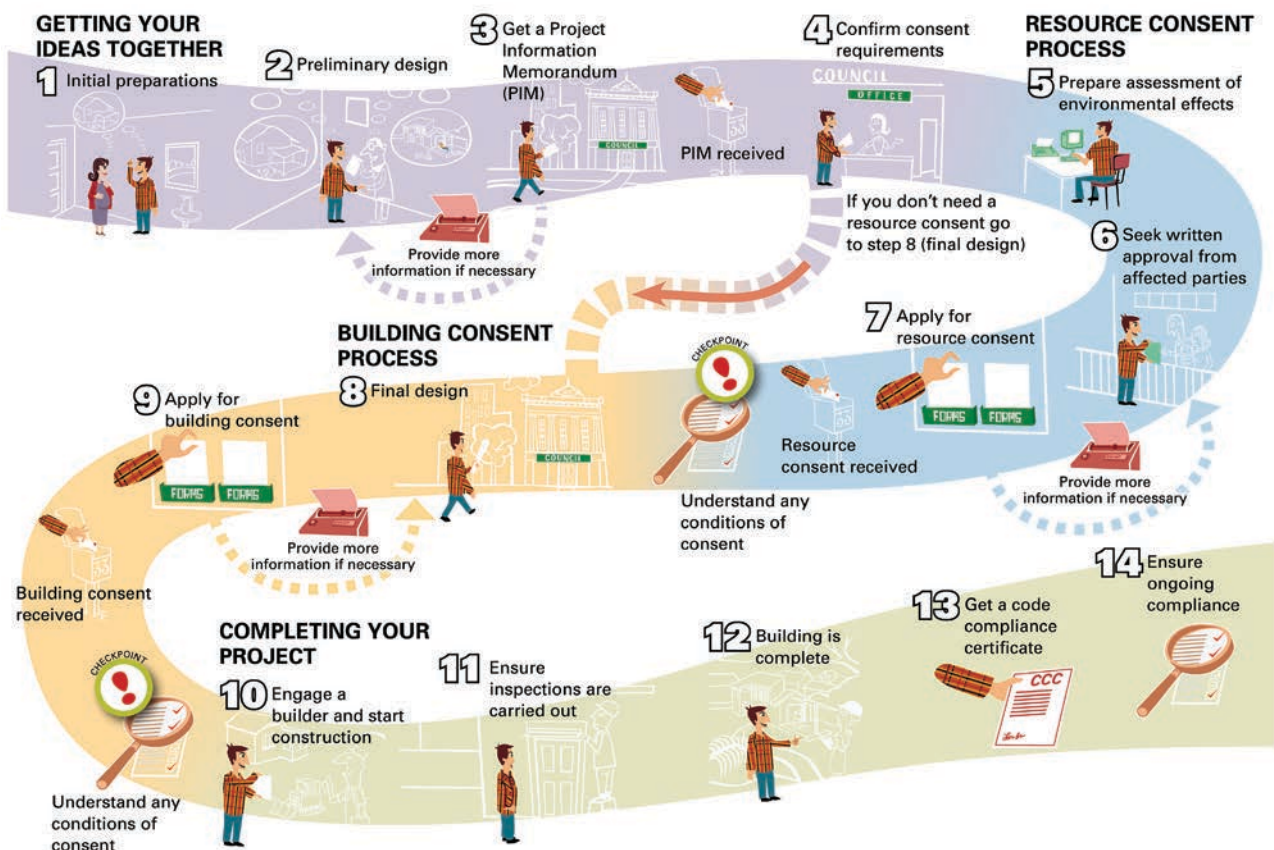

## 6.4 RETAINING WALLS

The BA's definition of a retaining wall is interpreted so that if a FDE pond, tank, sump or other retaining wall structure (for example constructed of concrete, steel or timber) is not higher than 1.5 m and does not support any load, then it will not require a building consent. This decision will probably also depend on the retaining structure's construction, function, depth and geometry.

If a retaining structure is in a rural zone and is required to retain more than 1.5 m but less than 3 m, it will probably also be exempt from the Building Consent requirement, but only if the design is reviewed by a CPEng and is not required to support a load, for example a farm vehicle or building (refer Table 6.4).

*Table 6.4: Excerpt from Building Act (2004), Schedule 1*

<p><b>Part 3</b></p> <p><b>Building work for which design is carried out or reviewed by chartered professional engineer</b></p> <p><b>41 Retaining walls</b></p> <p>(1) Building work in connection with a retaining wall in a rural zone, if –</p> <p>(i) the wall retains not more than 3 m depth of ground; and</p> <p>(ii) the distance between the wall and any legal boundary or existing building is at least the height of the wall.</p> <p>(2) In subclause (1), rural zone means any zone or area (other than a rural residential area) that, in the district plan of the territorial authority in whose district the building work is to be undertaken, is described as a rural zone, rural resource area, or rural environment, or by words of similar meaning.</p>
---

## 6.5 SAFETY FROM FALLING

Structures from which people could fall, (for example bunkers, retaining walls, platforms, ladders and stairways) need to comply with building regulations as well as triggering the need for a building consent from the BCA.

Not all such structures are in locations where people are likely to fall from them. Therefore, the need for specific safety provisions needs to be judged in terms of the nature and frequency of use.

In deciding what safety measures should be designed into structures, consideration needs to be given to all relevant factors affecting the user's safety including:

- The reason for access (for example, plant servicing)
- The intended frequency of use
- The need to carry tools or materials by hand.

The Code requires barriers where people could fall 1 m or more, and roofs with permanent access pools. It sets the characteristics required of barriers, for example, being continuous for the full extent of hazard and having appropriate rigidity, strength and height.



Table 6.5: Excerpt from Building Regulations 1992, Schedule 1, Building Code, F4 Safety from Falling

Safety from Falling – Clause F4
F4.1 The objective of this provision is to safeguard people from injury caused by falling
F4.3.1 Where people could fall 1 m or more from an opening in the external envelope or floor of a <i>building</i> , or from a sudden change of level within or associated with a <i>building</i> , a barrier shall be provided
F4.3.2 Roofs with permanent access shall have barriers provided.
F4.3.4 Barriers shall: <ul style="list-style-type: none"> <li>(a) Be continuous and extend for the full extent of the hazard,</li> <li>(b) Be of appropriate height,</li> <li>(c) Be constructed with <i>adequate</i> rigidity,</li> <li>(d) Be of <i>adequate</i> strength to withstand the foreseeable impact of people and, where appropriate, the static pressure of people pressing against them.</li> <li>(e) Be constructed to prevent people from falling through them</li> </ul>
Limits on application: Performance F4.3.1 does not apply where such a barrier would be incompatible with the <i>intended use</i> of an area, or to temporary barriers on <i>construction</i> sites where the possible fall is less than 3 m.

Table 6.6: Excerpt from Compliance Document for New Zealand Building Code, Clause F4, Safety from Falling

Barriers – Acceptable Solution F4/AS1
1.2.1 Minimum barrier heights on stairs or ramps 900 mm, other locations 1100 mm
1.2.2 In areas used exclusively for emergency or maintenance purposes in buildings, and in other buildings not frequented by children, barriers may have openings with maximum dimensions of either: <ul style="list-style-type: none"> <li>(i) 300 mm horizontally between vertical balustrade members, or</li> <li>(ii) 460 mm vertically between longitudinal rails.</li> </ul>

## 6.6 ACCESS

Access Routes (Clause D1) ensures people can move safely into, within and out of buildings. Access routes include the approach to the entrance of a building, corridors, doors, stairs, ramps and lifts.

It sets out requirements for:

- slip resistance, stair treads, handrails and cross falls
- people with disabilities to carry out normal functions within buildings
- the movement, loading and parking of vehicles.

AS 1657–2013 provides an Alternative Solution for the design, construction and installation of fixed platforms, walkways, stairways and ladders.

*Table 6.7: Excerpt of Building Regulations 1992, Schedule 1, Building Code, D1 Access Routes*

Access Routes
<p>D1.1 The objective of this provision is:</p> <p>(i) safeguard people from injury during movement into, within and out of <i>buildings</i></p>
<p>D1.3.1 <i>Access routes</i> shall enable people to:</p> <p>(i) safely and easily approach the main entrance of <i>buildings</i> from the apron or <i>construction edge</i> of a <i>building</i>,</p> <p>(ii) enter <i>buildings</i>,</p> <p>(iii) move into spaces within <i>buildings</i> by such means as corridors, doors, stairs, ramps and lifts</p>
<p>D1.3.3 Access routes shall:</p> <p>(i) have <i>adequate</i> activity space,</p> <p>(ii) be free from dangerous obstructions and from any projections likely to cause an obstruction,</p> <p>(iii) have a safe cross fall, and safe slope in the direction of travel,</p> <p>(iv) have <i>adequate</i> slip-resistant walking surfaces under all conditions of normal use,</p> <p>(v) include stairs to allow access to upper floors irrespective of whether an escalator or lift has been provided,</p> <p>(vi) have stair treads, and ladder treads or rungs which:</p> <p style="padding-left: 20px;">(i) provide <i>adequate</i> footing, and</p> <p style="padding-left: 20px;">(ii) have uniform rise within each flight and for consecutive flights,</p> <p>(vii) have stair treads with a leading edge that can be easily seen,</p> <p>(viii) have stair treads which prevent children falling through or becoming held fast between treads, where open risers are used,</p> <p>(ix) not contain isolated steps,</p> <p>(x) have smooth, reachable and graspable handrails to provide support and to assist with movement along a stair or ladder,</p> <p>(xi) have handrails of adequate strength and rigidity as required by (Building Code) Clause B1 structure,</p> <p>(xii) have landings of appropriate dimensions and at appropriate intervals along a stair or ramp to prevent undue fatigue,</p> <p>(xiii) have landings of appropriate dimensions where a door opens from or onto a stair, ramp or ladder so that the door does not create a hazard,</p>

Table 6.8: Excerpt of Compliance Document for New Zealand Building Code, Clause D1, Access Routes

Access Routes – Acceptable Solution D1/AS1
5.1.1 Types of fixed ladders (i) Step-type ladders, b) Rung-type ladders, c) Individual rung-type ladders
11.0.2 Commercial vehicles – AS 2890: Part 2 is an acceptable solution for loading spaces and circulation routes for commercial vehicles, but may exceed the requirements of Building Code D1.
11.0.3 Access routes for service and maintenance personnel – NZS/AS 1657 is an acceptable solution for fixed platforms, walkways, <i>stairways</i> , and ladders, (but provisions may exceed the requirements of Building Code D1).
<p>Comment: Where ladders are proposed, due consideration needs to be given to all relevant factors affecting the user's safety including:</p> <ul style="list-style-type: none"> <li>• the reason for access (e.g. plant servicing or inspection of passive building elements such as roofs)</li> <li>• the intended frequency of use</li> <li>• the need to carry tools or materials by hand.</li> </ul>

## 6.6.1 Fixed platforms, walkways, stairways and ladders

### Fall Protection

The most effective fall protection occurs at the design stage by selecting the most appropriate means of access. Furthermore, they should take into consideration the skill level, competency and capability of the people using the access system.

### **AS 1657: Fixed platforms, walkways, stairways and ladders. Design, construction and installation**

Australian Standard AS 1657-1992 sets out the requirements for the design, selection, construction and installation of fixed platforms, walkways, stairways and ladders that are intended to provide safe access to places used by operating, inspection, maintenance and servicing personnel. It has been adopted by the Standards Council of New Zealand and issued as a joint AS/NZS standard.

Standards Australia have subsequently issued an update as AS 1657-2013 but this is yet to be formally adopted in New Zealand. Designers and constructors should aim to meet this improved standard to provide “acceptable solutions” to meet the NZ Building Code.

### Means of Access

AS 1657-2013 states that there shall be a means of access and egress to zones where there is a foreseen need for access for operating, inspection, maintenance and servicing equipment. Figure 6.3 illustrates the limits of slope angle for different access means, from less preferable options such as rung-type ladders through to more preferable solutions such as stairways and walkways. Table 6.9 provides guidance on suitable solutions of fixed access means based on slope angle.

Figure 6.3 Selection of Access – Limits of Slope Angle (Adapted from AS 1657–2013 Fig 2.1)

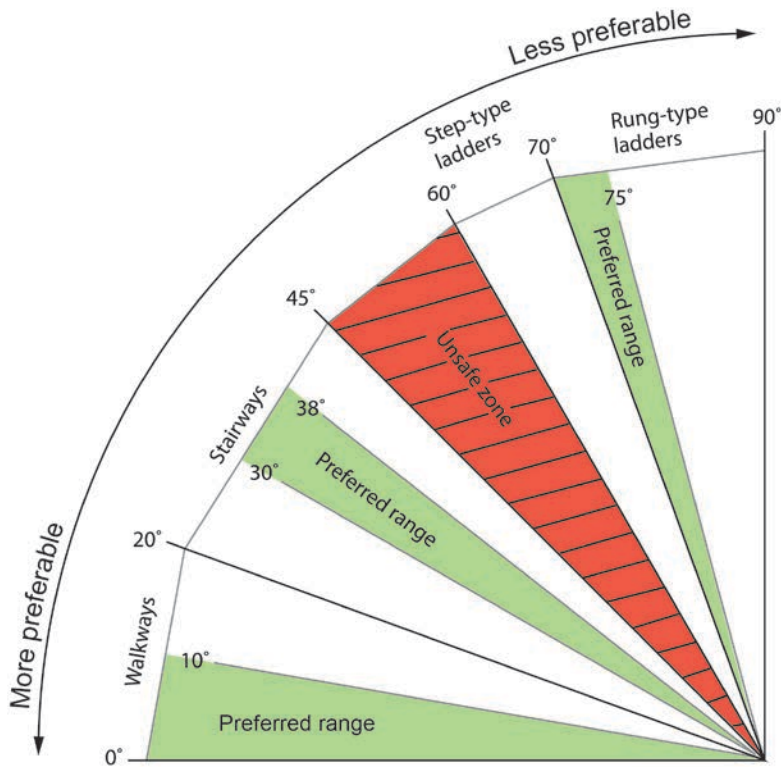

\*For twin-stile rung-type ladders

Additionally, AS 1657 provides minimum (or maximum) dimensions for the combined built elements that together form the means of access, such as a ladder or stairway.

### Ladders

Rung-type ladders are **not** considered suitable for any part of an access route to machinery or mechanical plant rooms where service access is required at least monthly, and where tools or materials need to be carried. Rung-type ladders may however be appropriate to certain areas (but subject to height) such as roofs, pits, silos, and tanks where access is required infrequently and tools and materials are only occasionally carried.

Step-type ladders are safer than rung-type ladders and should be considered where periodic access is required. They must also be fitted with a side screen or similar to prevent sideways fall.

Figure 6.4 Typical Dimensions for Step-type Ladders (Adapted from AS 1657-2013 Fig 7.4)

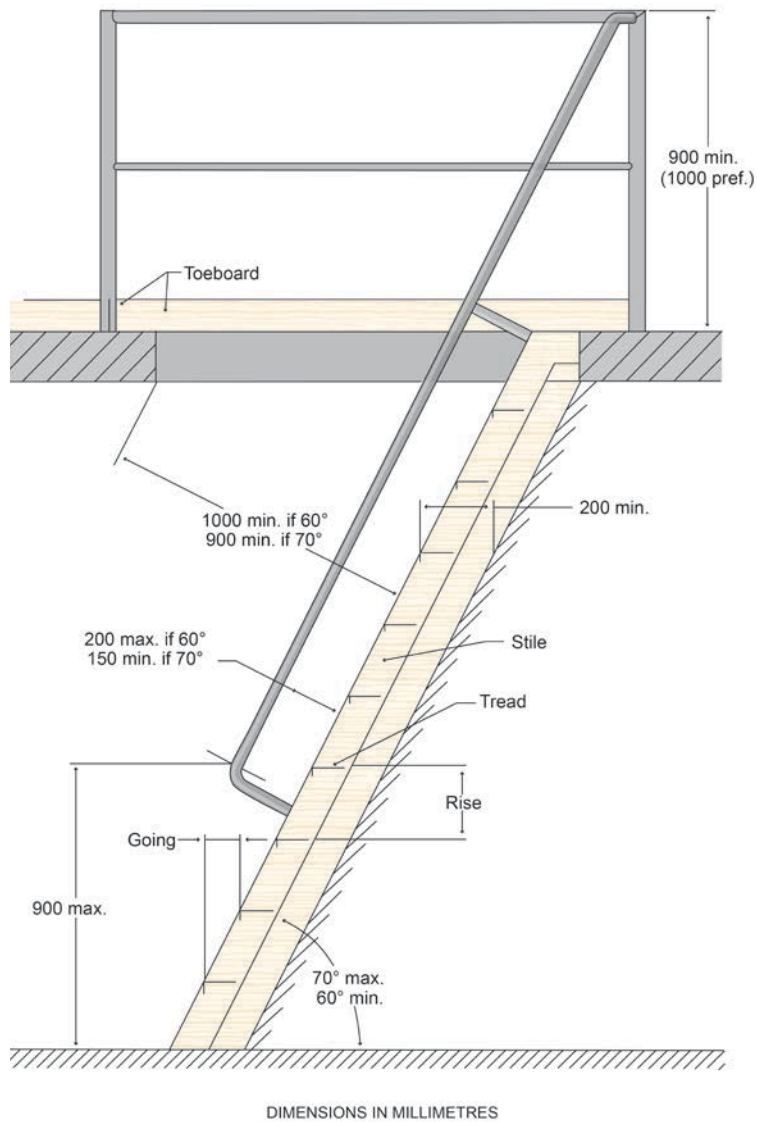

Table 6.9 Selection of means of Fixed Access (Adapted from AS 1657–2013 Table G1)

Angle	Type of Access	Considerations	Other Issues	Application
0° to 3°	Level walkway (Section 5)	<ul style="list-style-type: none"> <li>Frequent access required</li> <li>Suitable for use when light loads or tools need to be carried</li> </ul>	<ul style="list-style-type: none"> <li>Slip resistance of walking surface important</li> <li>Preferable to a stair with 2 or 3 steps</li> </ul>	<ul style="list-style-type: none"> <li>Roof access</li> <li>Access between service platforms</li> <li>Plant or maintenance access</li> </ul>
3° to 20°	Sloping walkway (Section 5) preferred range is 3° to 10°	<ul style="list-style-type: none"> <li>Suitable for use where there is a small vertical distance</li> <li>Good for emergency evacuations</li> <li>Suitable for two-way traffic</li> <li>Less physical effort required than stairs or ladders</li> <li>Transverse walkways to have a level walking surface</li> </ul>	<ul style="list-style-type: none"> <li>Guardrailing complying with Section 6 and incorporating handrails may be required</li> <li>Slip/fall protection required when angle of slope is 15° or greater</li> <li>Width of walkway to be selected to suit expected use</li> </ul>	<ul style="list-style-type: none"> <li>Warehouse loading area access</li> <li>Access across unsafe areas</li> <li>Access across inclined roof areas</li> </ul>
20° to 45°	Stairways (straight flights) (Section 7) preferred range is 30° to 38°	<ul style="list-style-type: none"> <li>Frequent access required</li> <li>Suitable for use when light loads or hand tools need to be carried</li> <li>Good for low to medium heights</li> <li>Suitable for emergency evacuations</li> <li>Suitable for two-way traffic</li> <li>Less physical effort required than ladders</li> </ul>	<ul style="list-style-type: none"> <li>Not less than 2 risers</li> <li>Maximum height of single flight is 4050 mm (18 risers at 225 mm)</li> <li>Width and angle of stair to be selected to suit expected use</li> </ul>	<ul style="list-style-type: none"> <li>Roof access</li> <li>Access to and between service platforms</li> <li>General plant access</li> <li>Access to service bays</li> <li>Vehicle operator access</li> </ul>
60° to 70°	Step-type ladder (Section 7)	<ul style="list-style-type: none"> <li>Periodic access</li> <li>6 m maximum vertical distance between landings</li> <li>Use if there is no need to carry loads or large tools</li> <li>The structure precludes other preferred methods of access</li> </ul>	<ul style="list-style-type: none"> <li>Ensure that persons using the ladder can only do so when facing the ladder</li> <li>Consider need for restricted access or locked-off</li> </ul>	<ul style="list-style-type: none"> <li>Mobile plant access</li> <li>Vehicle load access</li> <li>Access to low level landings or platforms</li> <li>Step-over for pipework or other obstructions</li> </ul>

Angle	Type of Access	Considerations	Other Issues	Application
<b>70° to 90°</b>	Rung-type ladder (twin-stiles) (Section 7) preferred range 70° to 75°	<ul style="list-style-type: none"> <li>• Infrequent access</li> <li>• 6 m maximum vertical distance between landings</li> <li>• There is a need to carry large tools or equipment</li> <li>• Not specifically intended for evacuation purposes</li> <li>• Physically harder to use than other types of access</li> </ul>	<ul style="list-style-type: none"> <li>• Ladders exceeding 6 m in fall distance require a cage or fall protection device</li> <li>• Generally intended for single person use</li> <li>• Consider need for restricted access or locked-off</li> </ul>	<ul style="list-style-type: none"> <li>• Access to plant or structure where limited space precludes other forms of access</li> <li>• Towers or masts</li> <li>• Mobile plant</li> </ul>
<b>85° to 90°</b>	Rung-type ladder (single-stile) (Section 7)	<ul style="list-style-type: none"> <li>• Use only where other means of access cannot be used</li> <li>• Consider 6 m maximum vertical distance between landings</li> <li>• Used in a near-vertical slope only</li> </ul>	<ul style="list-style-type: none"> <li>• Ladders exceeding 3.5 m in fall distance require some form of fall-arrest system</li> <li>• Must be restricted access or locked off</li> </ul>	<ul style="list-style-type: none"> <li>• Tele-communications masts</li> </ul>
<b>80° to 90°</b>	Individual rung-type ladder (step-irons) (Section 7) preferred range 80° to 90°	<ul style="list-style-type: none"> <li>• Infrequent access</li> <li>• Use only where other means of access cannot be used</li> <li>• Used in near-vertical distance between landings</li> <li>• 6 m maximum vertical distance between landings</li> <li>• Provision required for safe access onto and off the ladder</li> </ul>	<ul style="list-style-type: none"> <li>• Ladders exceeding 3.5 m in fall distance require some form of fall-arrest system</li> <li>• Single person use only</li> <li>• Must be restricted access or locked off</li> <li>• Corrosion protection required</li> </ul>	<ul style="list-style-type: none"> <li>• Access to plant or structure where space precludes other forms of access</li> <li>• Stormwater and sewerage access pits</li> <li>• Electricity cable pits</li> </ul>

## 6.7 BUILDING CODE AND INDUSTRIAL WASTES

Section G1 of the Building Code does not define FDE as a hazardous material; nor is it listed in Table 1 of section G14 as an example of industrial liquid waste. However, the section on storage, treatment and disposal facilities reproduced in Table 6.10 does provide some good-practice environmental and Health and Safety considerations when designing infrastructure containing or in contact with FDE.

*Table 6.10: Excerpt from Building Code Clause G14 – Industrial Liquid Waste*

**G14.3.2 Facilities for the storage, treatment, and disposal of industrial liquid waste must be constructed –**

- (a) with adequate capacity for the volume of waste and the frequency of disposal; and
- (b) with adequate vehicle access for collection if required; and
- (c) to avoid the likelihood of contamination of any potable water supplies in compliance with Clause G12 “Water supplies”; and
- (d) to avoid the likelihood of contamination of soils, groundwater, and waterways except as permitted under the Resource Management Act 1991; and
- (e) from materials that are impervious both to the waste for which disposal is required, and to water; and
- (f) to avoid the likelihood of blockage and leakage; and
- (g) to avoid the likelihood of foul air and gases accumulating within or entering into buildings; and
- (h) to avoid the likelihood of unauthorised access by people; and
- (i) to permit easy cleaning and maintenance; and
- (j) to avoid the likelihood of damage from superimposed loads or normal ground movement; and
- (k) if those facilities are buried underground, to resist hydrostatic uplift pressures.”



## 7. ANIMAL PRODUCTS ACT

To assist the dairy industry in meeting certain aspects of the Animal Products Act 1999, the Ministry for Primary Industries (MPI) has developed *Operational Code: NZCP1: Design and Operation of Farm Dairies*.

*Table 7.1: NZCP1: Introduction – Purpose*

“This Code describes the minimum standards applicable to all farm dairy activities to ensure that farm dairies and the equipment, facilities and services at farm, dairies are designed, located, constructed, and operated appropriately.”

The code covers the approval, design, installation, layout and operation of farm dairies and equipment installed in them to ensure the standard of performance is sufficient to ensure dairy products are fit for their intended purpose. When referenced as part of a risk management programme (RMP), *NZCP1* applies to; the siting, design, fabrication, construction, facilities, services and equipment, milk harvesting, milk storage, and all dairy processing operations and ancillary activities at farm dairies.

While this Practice Note specifically excludes guidance on dairy milking facilities, designers and installers of farm infrastructure still need to be familiar with *NZCP1*, and in particular Parts 2 to 4 as in Table 7.2.

*Table 7.2: Relevant Requirements (From NZCP1: Contents)*

Part 2: Summary of Standards for Farm Dairies		Part 4: Construction of the Farm Dairy	
2.1	Standards for all Farm Dairies	4.1	Floors, Yard Surfaces and Races
2.2	Requirements for Farm Dairies Producing Milk for Specialised Purposes	4.2	Kerbing
<b>Part 3: Location and Design</b>		4.3	Effluent Drains and Sumps
3.1	General	4.4	Disposal of Effluent and Other Wastes
3.2	Assessment of New Farm Dairies and Substantially Altered Farm Dairies	4.5	Offal Holes
3.3	Approval of Site and Plan	4.6	Amenities
3.4	Other Relevant Legislation	4.7	Walls, Ceilings, Roof Under-Surfaces
3.5	Location of the Farm Dairy	4.8	Doors and Ventilation
3.6	Tanker Roadways	4.9	Screens
3.7	Using a Public Road as a Race	4.10	Lighting
3.8	Minimum Approved Distances	4.11	Milk Storage Area
3.9	Water Supply	4.12	Storage Facilities
3.10	Alternative Premises and Equipment Designs	4.13	Milk not intended for Supply
		4.14	Fuel Burning Engines
		4.15	Hose Points
		4.16	Protection from Power Failure

Furthermore, and of particular relevance to farm infrastructure siting are the minimum approved distances from the areas where milk is harvested, received, stored or collected as detailed in Table 7.3.

Table 7.3: NZCP1: section 3.8(2) Table 1: Minimum Approved Distances

<b>The following minimum distances from the milking area, milk receiving area and milk storage room/area and milk collection point must be observed:</b>	
<ul style="list-style-type: none"> <li>Effluent ponds, Offal holes, Silage, Baleage, Dead animals</li> <li>Sand trap greater than 7.5 m<sup>3</sup> (refer clause 4.3)</li> <li>Drainage pad greater than 5 m<sup>3</sup>, associated with a sand trap and used for the purpose of removing sand and stones (refer clause 4.3)</li> <li>Cattle Loafing barns &amp; livestock housing without impervious cleanable floor surface (if permitted by Regional Council and no adverse animal health impact)</li> <li>Cattle feeding pad or standoff pad without impervious cleanable surface (if permitted by Regional Council and no adverse animal health impact)</li> </ul>	45 m
<ul style="list-style-type: none"> <li>Cattle Loafing barns &amp; housing with impervious cleanable floor surface; and Loafing barns and housing for other species</li> <li>Cattle feeding pad or standoff pad with impervious cleanable surface; and feeding pad or standoff pad for other species</li> <li>Housing for milking animal off-spring 0 to 3 months</li> <li>Hay barns and hay</li> <li>Buildings not associated with farm dairy activities and not otherwise specified</li> <li>Fertiliser bins/storage</li> <li>Supplementary feed storage</li> <li>Bulk fuel storage</li> <li>Chemical preparation and storage (pesticides and other chemicals not approved for use in the farm dairy)</li> <li>Dairy effluent sumps between 22,500 and 100,000 L capacity (temporary storage – refer clause 4.3)</li> <li>Recycled water storage in a fully enclosed tank with a maximum capacity of 30,000 L</li> </ul>	20 m
<ul style="list-style-type: none"> <li>Dairy effluent sumps up to 22,500 L (no storage – refer to clause 4.3)</li> <li>Sand trap (stone trap) intended to hold a volume not exceeding 7.5 m<sup>3</sup> at any time (refer clause 4.3)</li> <li>Drainage pad or effluent solids storage bunker intended to hold a volume not exceeding 5 m<sup>3</sup> at any time, (refer to clause 4.3)</li> <li>Sewage sumps or septic tanks</li> </ul>	10 m
<p>Loafing barns, housing, feed pads and standoff pads for cattle and buffalo must be constructed with have an impervious surface that is connected to an effluent system that complies with clauses 4.3, 4.4, 6.14 and 6.17.1 of this Code as well as any relevant local authority requirements.</p> <p>Supplementary feed may be stored closer to the farm dairy provided the feed silo is located over a concrete pad, is fully enclosed, connected to the farm dairy by an augur and is protected from pest activity. In addition, the storage vessel should be at least 10 m from the milk vat.</p>	

The code also details requirements for drains, sumps and traps and is reproduced in Part 2 section 5.2.

## 8. ANIMAL WELFARE ACT

Included in the Animal Welfare Act are requirements for:

- Ensuring that owners of animals and persons in charge of animals attend to the proper welfare of animals (Part 1)
- Permissible conduct in relation to animals (Part 2)
- Establishing procedures for the development of codes of welfare (Part 5), that
  - relate to animals owned by any person, or are in charge of any person
  - establish minimum standards to the way in which persons care for such animals
  - includes recommendations on best practice in caring for animals.

### 8.1 CODE OF WELFARE

While the Animal Welfare Act establishes obligations relating to the care of animals in general terms, specific detail for dairy cattle is found in the *Code of Welfare, Dairy Cattle*. The code is administered by MPI and is intended to be applied by all persons responsible for the welfare of dairy cattle.

Furthermore, while the code places responsibility for meeting minimum standards for the provision, design and maintenance of facilities and equipment on the owner and every person in charge of the dairy animals, it is incumbent upon the designer, supplier or installer of such infrastructure to provide their services in a way that will allow these standards to be met.

In the provision of farm dairy infrastructure elements that are covered by this Practice Note, the following minimum standards reproduced from the code are relevant.

*Table 8.1: Excerpts from Code of Welfare, Dairy Cattle, Sections 4.3, 4.4 and 4.5 (Minimum Standards 7, 8 and 9)*

Minimum Standard No. 7 – Farm Facilities
Farm facilities must be constructed, maintained and operated in a manner that minimises the likelihood of distress or injury to animals.
<p><b>Recommended Best Practice</b></p> <ul style="list-style-type: none"> <li>(i) Races should be constructed so as to enable dairy cattle to walk comfortably, with minimum risk of distress or injury.</li> <li>(ii) The surface of the dairy yard should provide satisfactory footing and be easily cleaned.</li> <li>(iii) Floors should have non-slip surfaces.</li> <li>(iv) Fences, gates and loading ramps should be designed to allow good animal flow and to prevent injury. Loading ramps should be carefully constructed with non-slip footing and with side boards or rails to prevent animals falling off or getting their legs trapped.</li> <li>(v) Head bails and crushes should be constructed to allow efficient handling of dairy cattle i.e. they should not endanger the animal, or the operator, and should allow for easy release to avoid choking.</li> <li>(vi) Handling facilities should be available to manage dairy cattle safely when undergoing routine procedures and for animals that require treatment.</li> </ul>

**Minimum Standard No. 8 – Stand-off Areas and Feed Pads**

Dairy cattle must be able to lie down and rest comfortably for sufficient periods to meet their behavioural needs.

**Recommended Best Practice**

- (a) After standing on concrete surfaces for 12 hours or more per day, for more than three consecutive days, cows should be given at least one full day on a suitable alternative surface, where they are free to lie down and rest.

**Comment**

Cows are likely to suffer significant discomfort if the surface type and area per cow are not appropriate for the frequency of use. This discomfort may reveal itself as reduced lying time, underfeeding and an increased incidence of mastitis and lameness.

**Minimum Standard No. 9 – Housing Cows and Calves**

- (a) Dairy cattle must be able to lie down and rest comfortably for sufficient periods each day to meet their behavioural needs.
- (b) All fittings and internal surfaces, including entry races and adjoining yards that may be used by the housed animals, must be constructed and maintained to ensure there are no hazards likely to cause injury to the animals.
- (c) Ventilation must be sufficient to prevent a build-up of harmful concentrations of gases such as ammonia and carbon dioxide.
- (d) If ammonia levels of 25 ppm or more are detected within the housing, immediate action must be taken to reduce the ammonia levels.
- (e) All sharp objects, protrusions and edges, including damaged flooring likely to cause injury to dairy cattle, must be removed, repaired or covered.

**Recommended Best Practice**

- (a) The bedding area should be well drained and covered with dry comfortable material.
- (b) Soiled bedding should not be allowed to accumulate to a level that poses a threat to the health and welfare of the animals.
- (c) The building should be designed to ensure that air circulation, dust levels, temperature, relative humidity and gas concentrations are kept within limits which are not harmful to the dairy cattle. Ammonia levels should not consistently exceed levels of 10–15 ppm.
- (d) Lighting that is sufficient to enable inspection of all animals kept indoors (20–50 lux) should be available but should not be so intense as to cause discomfort to the animals.

# PART 2

## **SOLIDS SEPARATION**

---

# 1. INTRODUCTION

---

As dairy farms intensify, the need increases for Farm Dairy Effluent (FDE) systems to include a solids removal stage. While providing a number of advantages, solids removal is a substantial capital investment and brings an additional set of operational requirements to the farm effluent system. The variability of FDE and the farm operational environment present a unique set of design challenges quite different to other wastewater situations. An effluent systems designer must understand the local dairy farm environment and ensure systems are robust, can operate for with minimal attention, and, if malfunctions occur, avoid spillage to the environment.

The designer will need to consider the whole FDE system consisting of sumps, pumps, solids management and irrigation. The solids separation process is just one part of the system and should not be treated as a single component to be supplied and “plugged in”. Equipment, such as pumps, screens and presses, should not be specified without consulting with a supplier or manufacturer who has in-depth knowledge of what components are best suited to a particular farm operation type and how best to set them up.

It is not the intent of this Practice Note to critique particular solids separation equipment, designs or manufacturers. However, it offers guidance on what should be considered in designing or upgrading effluent systems, and selecting solids separation components within that system.

## Key Points

- The designer needs to understand the farms management practices and intended use of captured and processed FDE
- The FDE solids content produced from the farm’s activities, and therefore equipment settings, will vary through the year
- The optimal location for solids separation equipment on-farm will depend on site and operational factors
- Careful analysis and comparison of suitable solid separation systems needs to be undertaken by the designer in consultation with the farm owner/client
- The solids management system must be designed and configured to be fail-safe
- Means of eliminating or isolating potential health and safety related hazards must be designed into the system
- Regional council requirements and individual farm consent conditions vary throughout New Zealand
- Building consents and professional design and sign off may be required for structures.

## 2. FDE SOLIDS

### 2.1 NATURE OF FDE SOLIDS

A key characteristic of FDE is its variability. Farms that vary feed and management regimes throughout the year will create dairy effluent with variable characteristics. These changes can be frequent and abrupt as different feeds are introduced to herd diet or pasture quality changes.

*Table 2.1: FDE Solids Composition*

FDE Solids Composition	
<b>Inorganic solids</b>	Solids in the form of stone, sand and grit will be tracked in with cows from the races to the dairy shed. The nature and quantity of this material will reflect the local soils and the materials used to surface races. The quantity of inorganic solids in the FDE will be weather dependent, with minimal amounts in dry weather but very large quantities in wet weather. Wherever an FDE system incorporates whole effluent pumping, mechanical solids separation, or geomembrane lined ponds, then effective stone removal is essential.
<b>Organic solids</b>	Solids can comprise partially digested grass/feed from manure, feed pads and waste feed. For example, grass silage, maize and palm kernel expeller (PKE). While these organic solids are fibrous, their length and consistency will vary greatly with cow diet, farm management and time of year. The texture of some supplementary feeds, such as PKE is hard and can be abrasive to some pump and solid separator components.
<b>Other</b>	<p>FDE will contain a wide range of litter or debris including:</p> <ul style="list-style-type: none"> <li>• Plastics, for example, heat mount detectors, syringes and caps, plastic bags</li> <li>• Animal waste such as hair, tail clippings, cow teeth, pieces of afterbirth</li> <li>• Vegetation such as leaves, sticks and wood, either tracked in with cows from nearby shelter, or included with supplementary feed. Some silages can contain woody litter including pinecones.</li> </ul> <p>While good housekeeping around the farm dairy will minimise solids and litter, these materials will inevitably become incorporated into the FDE. Therefore, the pumping and solids removal processes need to be able to cope with these objects.</p>

### 2.2 GENERAL CONSIDERATIONS

#### 2.2.1 Solids separation

The proposed method of safe removal of solids from a FDE storage pond or tank needs to be considered during design so that damage to any liner is avoided during desludging operations. This risk is reduced when the FDE is initially separated and solids can be collected and disposed of separately to the liquid portion of FDE.

Another advantage of separation is that the separated liquid effluent can be pumped more efficiently over longer lengths, facilitating irrigation over larger areas. Palatability of effluent irrigated pasture is improved where the sward is not coated with FDE solids, which is another advantage of their removal prior to irrigation.

However, depending on the separation method used, percentages of suspended solids remaining in the separated liquid effluent can still be relatively high. The effluent solids suspended levels from mechanical separators can be greater than 4 kg/m<sup>3</sup>. Some solids will still accumulate in storage ponds or tanks and this needs to be considered in deferred FDE storage design and management.

### **2.2.2 Application rates**

Low effluent application rates are usually best achieved with small sprinkler/irrigator nozzle diameters. Plant uptake of FDE nutrients is maximised when FDE is applied to pasture by irrigation, especially where there is “pulsing”, for example, 10 minutes on and 50 minutes off.

Small nozzle orifices and coarse solids are not a good combination, with a higher risk of blockages. Some styles of pivot irrigator have limitations around the maximum particle size of injected screened FDE.

### **2.2.3 Solids as a resource**

A successful FDE solids removal process will generate large quantities of organic manure, particularly where feed pads are included. The solids are an excellent soil conditioner when composted or matured and applied directly to land.

FDE applied as part of a farm nutrient management system can provide a reduction in the quantities of costly imported fertiliser required.

## **2.3 WHEN MIGHT SOLIDS REMOVAL NOT BE APPROPRIATE?**

Solids removal is not an essential step in every FDE system, and some farms will be able to operate successfully without it. This is more likely when:

- Only effluent from the farm dairy is collected
- Rainfall is low
- Soils are low risk
- Higher application rates are acceptable
- Herd size is small.

As a farm with low risk soils will generally be able to sustain higher effluent application rates, there may not be the same need for low application rate irrigation which necessitates the use of smaller diameter irrigator nozzles.



## 3. SEPARATION METHODS

### 3.1 ANAEROBIC SETTLEMENT PONDS

Anaerobic settlement ponds are widely used in some areas as a means of managing FDE solids. Essentially, this is a variant of the traditional two pond effluent system, with a deep 3 to 4 m anaerobic pond held at constant level, followed downstream by a variable level effluent storage pond. Flow between ponds is achieved by gravity; however, where natural fall is unavailable, a transfer pump to lift FDE between ponds can be installed.

An anaerobic settlement pond reduces the volume of solids through anaerobic digestion, and collects solids for spreading at a later time when farm operations and soil conditions suit. Some solids from the first pond may be removed by excavator depending on the pond lining material. More commonly the slurry is agitated with a stirrer, often with additional liquid from the second pond added, to facilitate subsequent removal by pump or tanker.

*Table 3.1: Anaerobic Settlement Ponds: Advantages and Disadvantages*

Anaerobic Settlement Ponds: Advantages and Disadvantages
<p><b>Advantages:</b></p> <ul style="list-style-type: none"> <li>• Operationally simple (provided there is gravity flow into and between ponds)</li> <li>• Provides deferred storage (in the second pond)</li> <li>• Possible use for gas collection.</li> </ul>
<p><b>Disadvantages:</b></p> <ul style="list-style-type: none"> <li>• Handling of solids is only deferred, albeit with some volume reduction</li> <li>• Hair and short fibres can pass through to secondary storage</li> <li>• Anaerobic pond effluents are prone to sliming in some irrigation systems</li> <li>• Pond contents will be anaerobic and highly odorous when mixed and spread</li> <li>• Desludging is a major operation with a large quantity of thin highly concentrated slurry material to be mixed, extracted and spread</li> <li>• Pond lining must be able to be protected during the desludging operation</li> <li>• The pond area will add substantially to the FDE catchment area for rain water. This needs to be accounted for in the Dairy Effluent Storage Calculator (DESC) calculations and will increase required effluent storage volumes, but is less of an issue in dry climates</li> <li>• Anaerobic ponds discharge methane to atmosphere. Greenhouse gas discharge may become a liability in the future under an Emissions Trading Scheme</li> <li>• Loss of nutrient value from the FDE. Storage of FDE in anaerobic ponds for extended periods will result in some loss of valuable nitrogen and organic carbon</li> <li>• Land area required for settlement ponds is large relative to some other effluent separation systems</li> <li>• Cost. Lined ponds can be expensive compared to other available options, especially when the cost of lining and regular desludging operations is considered.</li> </ul>

Ponds for anaerobic settlement solids storage should be designed and constructed as for effluent storage ponds outlined in *Practice Note 21*.

A solids barrier or filter needs to be incorporated into the anaerobic pond outlet to minimise solids carry over between storage ponds. Often this is achieved using a submerged “T” pipe to draw liquid from beneath the surface crust.

## 3.2 SLUDGE BED WITH WEEPING WALL

A sludge bed with a weeping wall is a common method of passive solid separation. The sludge bed is where effluent solids are contained while liquids are able to pass through a slatted wall that acts as a passive filter. Most filtering occurs through solids settlement in the sludge bed itself and not at the weeping wall.

Passive separation systems require sufficient length and width for incoming solid particles to slow down, drop and settle. Weeping walls are not intended to act as a large sieve where unseparated effluent is pushed hard up against the wall and liquid forced through. Rather, it is intended that liquid be allowed to slowly flow towards and through the wall.

### 3.2.1 Sludge bed design

The effectiveness of a sludge bed will be enhanced if the following design aspects are fully considered:

- Sludge beds that are long and narrow, with the weeping wall on the narrow end and opposite the inflow end, are more effective in retaining solids and drying the sludge. Where sludge beds are squarer, the flow forces are more easily dispersed and not as effective in pushing liquid from the sludge towards the wall
- If a larger bed area is required then the length should be increased, not the width. Sludge beds up to 75 m in length have been observed to be functioning satisfactorily. The distance between the inflow point and the weeping wall needs to be maximised to ensure that there are no areas in the sludge bed where the inflow will bypass the settling area. A recommended minimum length is 25 m
- The width of the sludge bed is one of the most important design factors. A sludge bed of 5 to 6 m minimum width at its mid-height is recommended (maximum 7 m), especially if it is intended to mechanically clean out the sludge bed from both sides as the design width will be restricted by the reach of the intended excavator to be used. The width of the base of beds with sloping side batters needs to be a minimum of 2 m to ensure sludge does not block the base of the weeping wall
- Sludge bed walls constructed from reinforced concrete with vertical or near vertical sides will require specific structural design. Panel joints that allow leak free, contraction and expansion movement is critical
- An alternative to concrete or similar permanent materials is a geomembrane-lined sludge bed with sloped sides. Where there are stable cut slopes, then 2(Horizontal):1(Vertical) sludge bed side slopes are possible. If a Geosynthetic Clay Liner is used, then a geogrid or similar material to retain the graded granular cover material on the slope should be considered. Steep side slopes, especially if constructed of clay, can become unstable over time and are not recommended. *Practice Note 21* Part 2, section 4 provides further guidance on these designs
- The invert level of all FDE inflow pipes must be above the maximum working height of the weeping wall to prevent it blocking from backed up FDE when the bed is full. The surface area around the inflow pipe opening must be protected from erosion
- Where sludge beds are deemed by the local Building Control Authority (BCA) to be a “tank”, or the bed walls constitute a retaining wall, then a building consent may be required
- A sludge bed floor should be flat, or have a very slight longitudinal grade (+0.5 per cent maximum) to allow positive drainage when the bed is empty. A greater slope toward the wall may place undesirable horizontal pressure against the wall and cause the weeping wall to block. The width of the base of beds needs to be a minimum of 2 m to ensure sludge does not block the base of the weeping wall
- Most sludge beds are around 1.5 m deep with the absolute minimum depth being 1 m. However, there are some sludge beds up to 2.5 m deep working effectively
- For smaller farms a single sludge bed can provide suitable separation, but only if it is of sufficient size, and has low rainfall with regular periods of dry weather

- The means by which sludge is to be cleaned out, while leaving the liner undisturbed from machine damage, must be considered in the design. A written desludging instructions sheet provided by the designer to the farm owner will assist.

### 3.2.2 Sludge bed operation

Most systems work more effectively once a layer of sludge has developed in the base of the sludge bed. It is advantageous to not completely remove all solids at the time of desludging. Leaving a sludge layer of at least 300 mm in the base will assist in “seeding” the sludge bed separation process, as well as providing protection to the liner from an excavator bucket.

Many farm owners claim good results by excavating out only the top two-thirds ‘crusty’ layer. The remaining bottom one-third continues to provide the previously established flow paths through to the weeping wall. It also provides a continuation of an established anaerobic function.

Following drying weather, if the surface fresh crust has dried out then this is the optimal cleanout time. If the fresh crust has substantially dried but then is allowed to be re-wetted by heavy rain, then it might not dry back as far as previously.

Retained effluent retained and removed from sludge beds is generally a wet semi-solid effluent product. The percentage of solids is typically 20 to 30 per cent by mass. The consistency of this product will depend on the farm feeding and effluent system.

### 3.2.3 Sludge bed volume calculations

The required volume of the sludge bed varies between farms, seasons and management. For FDE only from the dairy shed and yards, the average volume required is 1.5 to 2.0 L per cow per day. Where there are other sources of FDE apart from the shed, for example a feed pad this volume will increase depending on herd size and hours in use. Separate calculations of FDE solids volume ( $V$ ) for each FDE source need to be determined and then totalled. Calculation guidance for this is given in Figure 3.1.

Figure 3.1: Sludge Bed Volume Calculations

<p><b>FDE Solids Volume Generated:</b></p> $V_{FDE} = M \times P_{Ret} \times T$ <p>Where:</p> <p><math>V_{FDE}</math> = FDE Solids Volume (litres/cow/day)</p> <p><math>M</math> = Whole manure volume per hour (*3.4 litres/cow/hour)</p> <p><math>P_{Ret}</math> = Percentage of manure retained in sludge bed (*20%)</p> <p><math>T</math> = Hours per cow each day (hours/cow/day) on FDE contained surface</p> <p>* estimated (default) values</p>
<p><b>Total Solids Storage Volume Required:</b></p> <p>Volume sludge bed <math>V_T</math></p> $= (V_{FDE} [+ V_{FDE} \text{ from each and every other FDE source}]) \times n \times d / 1,000 \text{ (m}^3\text{)}$ <p>Where:</p> <p><math>V_T</math> = Total Volume of sludge bed (m<sup>3</sup>)</p> <p><math>n</math> = Total herd size (cows)</p> <p><math>d</math> = Days of effluent collection, between sludge bed emptying times.</p> <p>(Note: Volume must be enough to hold all effluent during periods where soil conditions do not allow land application. Volume allowance also needs to be made for any sludge bed freeboard.)</p>

*Figure 3.2: Example Sludge Bed Volume Calculation*

A dairy farm with 500 dairy cows where cows average 2.4 hours per day in the yards. They also spend 1.5 hours on a feed pad which is flood washed into the same effluent system. The feed pad is only used during the lactation period which is 305 days. The sludge bed effluent solids will be applied to land once per year to the cultivated cropping soils.

FDE Solids Volume (litres/cow/day) = 3.4 L x 20% x 2.4 hr

Solids Volume (litres/cow/day) = 1.63 litres/cow/day

Feed pad Solids Volume (litres/cow/day) = 3.4 L x 20% x 1.5 hr

Solids Volume (litres/cow/day) = 1.02 litres/cow/day

Total Volume of sludge bed (m<sup>3</sup>) = (1.63 + 1.02 litres/cow/day) x 500 cows x 305 days / 1,000 L

Total Volume = 404 m<sup>3</sup>

### 3.2.4 Sludge bed concept design

Two concept design options are offered in Figures 3.3(a) and 3.3(b) to aid designers. They both have reinforced concrete elements requiring specific design from a structural designer. Refer Part 4: Concrete Structures for concrete design criteria.

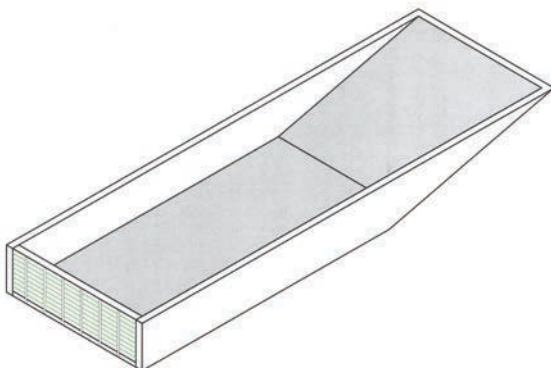
*Figure 3.3(a) Sludge Bed with Weeping wall: Concept Design (1)*

#### Concept Design (1) Features:

- Impermeable reinforced concrete construction, vertical walls in ground to provide backfill to support walls; specific structural design required
- Flat concrete floor and access ramp, maximum slope of 4(Horizontal):1(Vertical), grooved or roughened for traction
- Long narrow design, 5 to 6 m wide by 30 m long
- 2-metre-high weeping wall with plastic slat panels.

(Alternatively, the weeping wall in this concept design could be on the end of the side wall which would reduce horizontal forces when machine desludging.)

Figure 3.3(b) Sludge Bed with Weeping Wall: Concept Design (2)

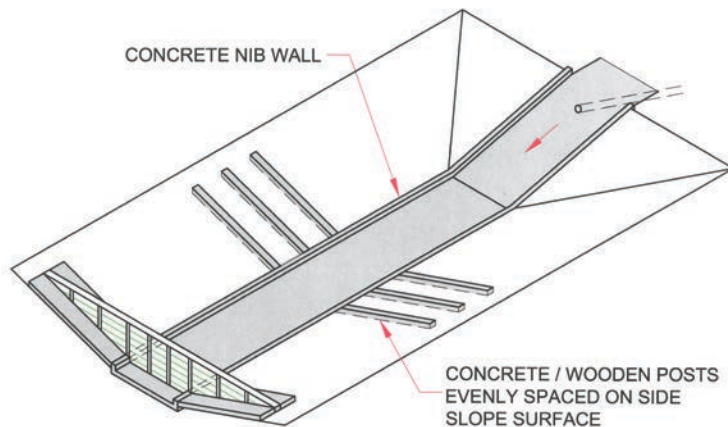

**Concept Design (2) Features:**

- Weeping wall, 5 to 6 m wide at mid-height, maximum 2 metres high with horizontal plastic slat panels, slat spacing to suit FDE particle size, (the unfilled triangular sections below each wall panel, could be blocked out with solid timber or reinforced concrete)
- Sides of maximum 2.5(Horizontal):1(Vertical) slope and flat base, fully encapsulated with a geomembrane liner such as geosynthetic liner with 300 mm depth of well graded sandy coarse gravel to provide a stable cover material, or HDPE with a protective geotextile
- An access ramp and centre strip constructed from (non-alloy) fibre reinforced concrete to protect the liner from damage from excavation machinery traversing along the strip. Slope of the ramp must not be too steep that the machine while loaded would be unable to reverse out of the bed
- 2 to 3 m wide flat concrete floor base, depending on width of available desludging equipment
- Reinforced concrete high nib wall, for machine scraping position guidance
- Concrete access ramp, maximum slope of 4(Horizontal):1(Vertical), grooved or roughened for traction
- Concrete or wooden posts placed evenly along the length of the side slopes to provide liner protection from over excavation.

(Alternatively, a clay liner could be used with the centre concrete strip being supported on top of the clay with a gravel bedding layer.)

### 3.2.5 Weeping wall design

Weeping walls need careful engineering design including considering the following points:

- A double sludge bed with a common collection channel may provide a structural advantage as the two facing weeping walls can be braced against each other
- The height of the weeping wall must be lower than the side wall crest level. This is to ensure the FDE is still contained in the event that the weeping wall is inadvertently over topped
- Concrete should be poured around the entire area around retaining posts to seal off FDE leaking out to groundwater. Furthermore, the concrete needs to be sealed to the sludge bed lining material to avoid leakage at this joint
- A concrete apron extending beyond the base of the wall is necessary to avoid surface erosion from the squirting FDE from the weeping wall, and to provide contained channelling to a sump, inlet pipe or fall to the storage pond. Note that the liquid may squirt an equivalent distance to the wall height
- PVC slatted panels are superior to wooden slats as they are dimensionally stable and do not rot, twist, warp, shrink or expand. If timber slats are used they need to be; smooth dressed, treated to H4, free of knots, tapered with the narrow edge on the downstream side. Although uncommon in New Zealand, concrete and steel grating panels are other options
- Gap widths depend on the farm system, inflow types, and feed types. The smaller the gap, the more solids are retained with a slower drainage rate. For 50 mm wide slats, gaps in-between are typically 6 to 8 mm for PVC panels, and 8 to 10 mm for timber slats. For scraped feed pads, gaps from 10 to 12 mm are common. Gaps may need to be larger; for more fibrous feed pad effluents, where there is a high proportion of excess feed or bedding materials such as woodchips or bark
- Gaps using wooden slats need to be slightly larger than when using PVC as timber will expand when wet and fibre can get caught on the rougher gap and reduce the effective opening width. Manufacturers of panels should be asked for guidance concerning the most applicable gap depending on the FDE composition
- If capping rails fitted along the top of the wall are intended to walk on, then they must have a handrail to provide protection from falling
- There appears to be little difference between weeping wall effectiveness whether slats are horizontal or vertical. With framing, especially when using vertical slats, it is important to ensure the supporting horizontal framing is raised approximately 100 mm off the concrete base to enable liquid to flow beneath. Weeping wall panels should go down to concrete base level
- The spacing of the supporting treated timber posts or poles will depend on factors such as; their cross-section size, wall height and proposed post foundation depth. Table 3.2 provides some guidance for builders of timber post weeping walls. Because of the significant loads against the face of the weeping wall it may need structural engineering design input.

Table 3.2: Weeping Wall Timber Post Design Table

Retention Wall Height (m)	Maximum Post Spacing (m)	Minimum Post Diameter (mm)	Minimum Embedment Depth (m)
<b>For concrete surrounded posts</b>			
1.0	1.25	150	1.1
1.2	1.1	175	1.2
1.4	1.0	175	1.4
1.6	1.0	200	1.6
1.8	0.9	225	1.7
2.0	0.9	250	1.9
<b>For driven poles</b>			
1.0	1.25	150	1.2
1.2	1.1	175	1.3
1.4	1.0	175	1.5
1.6	1.0	200	1.7
1.8	0.9	225	1.8
2.0	0.9	250	2.0
<p><b>Note:</b> The above design information assumes:</p> <ol style="list-style-type: none"> <li>(1) 50x50 mm slats treated to minimum H4 Standard with timber Grade SG8 (fb=14 MPa)</li> <li>(2) The ground into which the poles are to be placed can be considered as “good ground” in accordance with the definition given in Section 1.3 of NZS 3604:2011 and determined using Section 3.3, Test Method for Soil Bearing Capacity</li> <li>(3) Density of retained material maximum 16 kN/m<sup>3</sup></li> <li>(4) Timber poles treated to H5 Standard of normal characteristic stress (fb=38 MPa) for naturally round softwood timber in the green condition</li> <li>(5) For concrete surrounded posts, holes are pre-bored or excavated and the timber posts are surrounded by a 25 MPa concrete with minimum 50 mm cover to the sides and 100 mm to the bottom of the pole</li> <li>(6) For driven poles, poles are assumed to be driven into the ground without pre-boring or prior excavation. Ground surrounding the poles must be firm.</li> </ol>			

Vibrating weeping wall panels have recently entered the market with farm owners advising that they are not susceptible to blocking, unlike some other weeping wall arrangements. Vibration is applied for short periods to the installed stainless steel panel which activates the FDE to separate as it flows through the panel openings.



*Weeping wall (PVC outer panels, vibrating centre panel)*



*Weeping walls (timber)*

*Table 3.3: Sludge Beds with Weeping Walls: Advantages and Disadvantages*

<b>Sludge Beds with Weeping Walls: Advantages and Disadvantages</b>
<p><b>Advantages:</b></p> <ul style="list-style-type: none"><li>• Minimal day-to-day operational labour inputs required</li><li>• Low risk system for breakdowns</li><li>• Passive system with minimal operational costs if site fall allows (no pumps).</li></ul>
<p><b>Disadvantages:</b></p> <ul style="list-style-type: none"><li>• Higher initial capital cost relative to some other separation options</li><li>• Requires more land area than mechanical systems</li><li>• Higher cost where there is a high-water table and an above ground sludge bed is necessary</li><li>• When clean out is required it is a substantial operation involving shifting large amounts of anaerobic solids</li><li>• Higher moisture content of solids relative to some other systems.</li></ul>



### 3.3 SCRAPED SLUDGE BED WITH WEEPING WALL

#### 3.3.1 Feedpad sludge bed design

Where the effluent inflow is slurry or semi-solid then a modified approach should be taken to sludge bed design. A bed, either above (as illustrated for example in Figure 3.4), or below ground with sufficient space around the perimeter for the channelling of separated FDE and excavator access to the bed, has been observed to operate satisfactorily. The time taken for trapped liquid to drain can be variable.

The greatest influences that affect the drying out are pressure and heat, as well as the frequency of re-wetting from rain. Ideally, the bed will be the same width as the feed pad being scraped but this will depend on the calculated volume of FDE solids that needs to be held.

Where feed pads are used throughout the year for only a few hours a day, there is greater flexibility in sizing the sludge bed and the frequency of solids removal. The sludge bed volume however still needs to be large enough to store effluent during wet periods when land application of FDE is not possible. Gates or fencing offset to the front edge should be fixed to prevent animals (and staff) from falling or slipping into the sludge bed.

*Figure 3.4: Concept Design for Scraped Feed pad*

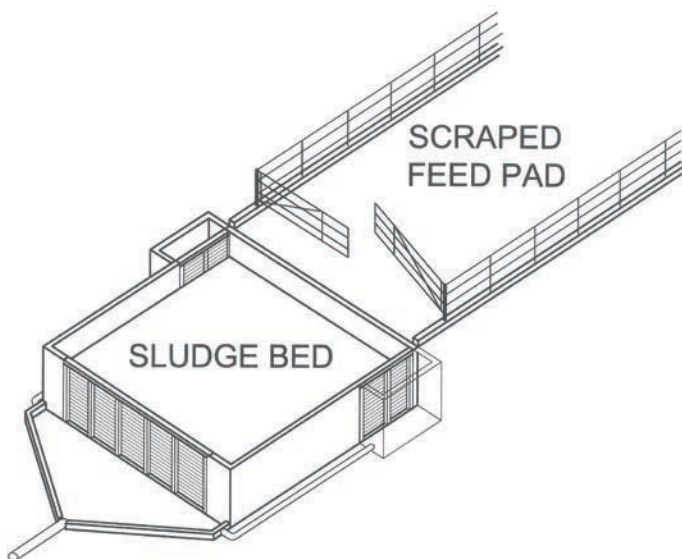

#### 3.3.2 Scraped feed pad weeping wall design

For scraped feed pads, the proposed positions of weeping wall panels determine if horizontal or vertical slats should be used. Where weeping wall panels are adjacent to the scraping direction, horizontal slats are recommended as vertical slats tend to block as the scrapings are pushed passed. On walls opposite the inflow point, either vertical or horizontal slats can be used.

Figure 3.5: Weeping Wall Panel Orientation

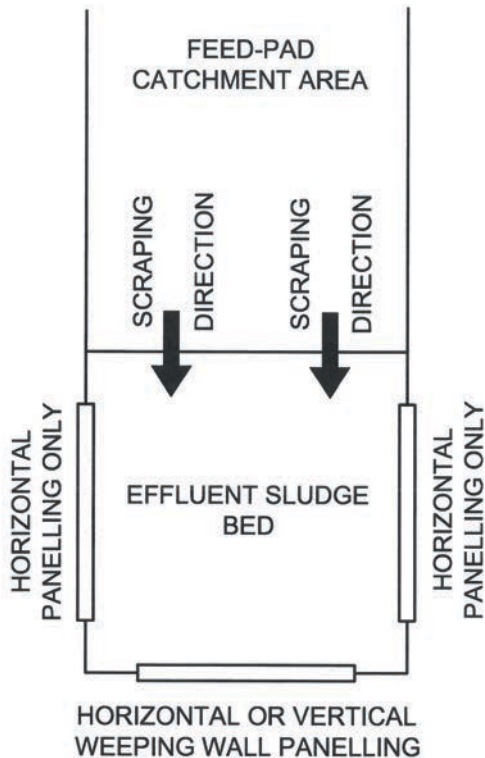

### 3.4 PRIMARY SCREENS

A range of proprietary systems based around screens is available. Screen gaps are typically 0.5 to 2.0 mm and should be considered as primary screens only. However, large amounts of fine solids and short fibre can still pass through these devices depending on screen type and size. These systems can be subdivided into two main types:

1. Passive sloping screens, and
2. Mechanical screening devices where either the screen or an auger is rotating.

When deciding which style of screen and evaluating capital investment, a good way to think of the various systems is as follows:

- A *static screen* and a *rotating drum screen* remove solids from the liquid
- A *screw press* device removes solids from liquid and also removes the liquid from the solids.

For all screen devices, the materials used in construction must be appropriate for FDE with either stainless steel or plastic for all parts and surfaces contacting FDE.

### 3.4.1 Static sloping screens

Static sloping screens comprise a steeply sloping screen of fine stainless wedge-wire. The screen has a flatter section at the base which allows solids to collect and form a dam, before solids periodically slough off to the bunker. Screened water is collected from behind the screen.

Critical factors in the design of an effective sloping screen installation are:

- The shape and curved profile of the screen surface
- The method used to distribute FDE across the screen. Effluent must be evenly applied across the full width of the screen to avoid channelling of the flow. Systems generally use a balance tank at the top and an overflow weir
- The wash system. Screens typically require a clean water wash at start up (to pre-wet the screen) part way, and at the end of the cycle. This helps to remove accumulating fines and leaves the screen clear at the end of the cycle so solids will not dry on the screen. The wash bars and nozzles need to be giving sufficient pressure, typically 300 kPa (or 3 Bar) to dislodge material, but cannot be too close to the screen or they may foul with solids in the FDE. Coverage of the screen by the wash nozzles is important
- Orientation of the screen to the sun can be a factor, with north facing screens reportedly more prone to drying of material on the screen, although this could be a reflection of poor wash efficiency
- Providing a safe access platform for servicing and washing of the screen
- Ensuring the associated bunker drainage will “fail-safe” in event of screen overload.

The wash system can be set up to use “green-water”, that is, screened effluent. However, this does add another level of complication to the wash system and solenoid valves. Generally, a clean water supply to the wash is preferable. The water use of screens is small in the context of the overall FDE system at typically less than 100 to 200 L per cycle. Wash systems can be customised to water availability and cleaning requirements.

*Table 3.4: Static Sloping Screens: Advantages and Disadvantages*

Static Sloping Screens: Advantages and Disadvantages
<p><b>Advantages</b></p> <ul style="list-style-type: none"> <li>• A relatively simple approach with no moving parts that requires little mechanical servicing</li> <li>• Only power requirements are for the initial effluent pumping to the top elevation and for the wash water. Although, this would normally be drawn from the farm supply and not require separate pumping. This is a possible advantage if the bunker is some distance from the power supply</li> <li>• Possibly lower capital cost than mechanical systems.</li> </ul>
<p><b>Disadvantages:</b></p> <ul style="list-style-type: none"> <li>• The screen does not dewater the extracted solids. The percentage of Dry Matter (DM) off a slope screen is typically around 7 to 11 per cent DM, but would be higher if allowed to stand in a stack for several weeks. This is a compostable firm but still very moist material (considerable water is easily squeezed by hand from the solids). Solids in the bunker will continue to leach effluent. Note, one manufacturer offers an option of additional rollers to dewater the solids</li> <li>• Slope screens work best with well-mixed and consistent feed slurry. If the screen overloads, there is no mechanism to prevent FDE running to the solids bunker. This is most unsatisfactory and can overload the return drain from the solids bunker</li> <li>• Some installations can require regular manual wash down (often weekly) in addition to the wash nozzles. In some installations, a gradual build-up of algal slime has been observed, although occasional applications of appropriately diluted dairy shed acid detergent can assist with reducing organic build up. Fat deposits if milk is being wasted to the effluent system may be a problem.</li> </ul>



*Typical static screen and bunker installation*

### 3.5 INCLINED AUGERS

Inclined augers are a screw press variant. An auger rotates within an inclined perforated screen. Effluent enters the machine at the base and is carried up the slope, losing moisture through the screen as it progresses, with solids expelled from the top. As effluent is being lifted by the auger it relies upon the close tolerance between the auger face and the screen to separate out the water (otherwise water just runs back). Machines have a hard rubber or nylon facing to the auger which contacts the screen directly.

These machines are effective when rubbers and screen are in good condition, producing relatively dry (greater than 22 per cent DM). However, they are vulnerable to damage to both the rubbers and the screen from grit. Grit can rapidly wear the auger facing. Grit catches in the screen perforations and then abrades the facing rubbers. The auger can catch a wedged stone and rip the screen. PKE from feed pads is reported as being hard on the rubbers.

Maintenance costs in some situations can be high for inclined augers. An effective stone trap, and its maintenance, is essential for this type of separator.

### 3.6 HORIZONTAL SCREW PRESS

A screw press operates on quite a different principle to the inclined auger. An auger rotates within a horizontal cylindrical wedge-wire screen (typically, with a 0.5 mm gap). The metal auger itself does not contact the screen; some brands of horizontal screw press separators have stiff nylon brushes that sweep the screen as the auger rotates. These brushes capture fibre which also assists with screen cleaning.

The machine relies upon back pressure from plates or doors at the outlet to form a dense plug of fibrous solids at the outlet end of the auger. This plug seals the chamber and prevents water spilling to the manure bunker. As the auger rotates, new solids are continually added to the plug which extrudes out the end. Depending upon the back pressure applied, these machines will produce a dry solids cake (25 to 40 per cent solids), with a dry (that is, no moisture can be squeezed by hand), crumbly material ideal for immediate dry spreading.

Mechanically the machines are relatively simple, small, with an electric motor driving the auger through a sturdy gear drive. Back pressure is applied either through counterweights or spring tension. The motor overload needs to be at a setting that will protect the motor in event of the plug becoming excessively tight.

*Table 3.5: Horizontal Screw Presses: Advantages and Disadvantages*

Horizontal Screw Presses: Advantages and Disadvantages
<p><b>Advantages:</b></p> <ul style="list-style-type: none"> <li>• Screw presses handle varying solids load well. A slug of solids coming through will reduce flow through the screen temporarily and cause the raw effluent to return to the pump sump until the auger catches up</li> <li>• The back pressure can be adjusted to maintain a consistent solids moisture content with seasonal changes to feedstock</li> <li>• Relatively low power cost</li> <li>• The solids produced are dry and easy to store and handle</li> <li>• High solids percentage minimises solids bunker storage volume.</li> </ul>
<p><b>Disadvantages:</b></p> <ul style="list-style-type: none"> <li>• The machine relies upon maintaining the plug as DM per cent changes. If backpressure is not set correctly for the feedstock, the plug can blow/erode out, allowing raw FDE to spill to the bunker</li> <li>• Excessive back pressure can form an overly dense plug leading to elevated wear to the motor, gear box and auger hardening.</li> </ul>

*Typical screw press installation*

### 3.7 ROTATING DRUM SCREEN

These machines are similar in principle to the “contra-shear” screens used for many years for solids removal in municipal and industrial wastewater treatment. The cylindrical screen rotates, FDE is introduced to the inside of the screen and water passes through the screen while the solids pass out by gravity due to the conical form of the screen. High pressure water sprays are used to clean the solids from the screen; these are usually pulsed rather than continuous.

Rotating drum screens are relatively simple machines suitable for high solids loading applications. They do not dewater the solids and hence after processing the material is at higher moisture content than from a screw press. A drum screen is a larger machine than an equivalent screw press.

*Table 3.6: Rotating Drum Screens: Advantages and Disadvantages*

Rotating Drum Screens: Advantages and Disadvantages
<p><b>Advantages:</b></p> <ul style="list-style-type: none"> <li>• High throughput relative to power used/motor size (a 1.5 kW machine can process 50 m<sup>3</sup>/hr)</li> <li>• Self-cleaning with rotating action of drum and water wash spray</li> <li>• Good choice for feed pad situations (with high solids loading) where the dry product produced by a screw press is not required.</li> </ul>
<p><b>Disadvantages:</b></p> <ul style="list-style-type: none"> <li>• Higher moisture content in solids</li> <li>• Water use in wash sprays</li> <li>• Size of unit and cost relative to throughput.</li> </ul>

## 4. SITING OF SEPARATION COMPONENTS

---

### 4.1 MECHANICAL AND PASSIVE SYSTEMS

Mechanical systems are those that require electrical power to operate, passive systems do not. In siting the various solids separation components, whether they are a mechanical or passive system, the following location principles should be adopted:

- The optimal location using a passive system is usually where all FDE produced (for example, from milking shed, feed pad, or stock underpass) can gravity flow into the top of the separation system; and where liquid from the outflow can further gravity flow through the system (for example, Option 2 Figure 4.1). During design, options should be analysed and ranked in order of preference based on pump and energy requirements and system simplicity
- If effluent is to be pumped to the solids removal stage, then a prior stone trap is essential to protect the pump from litter and grit
- Flow rate and sump size needs to be large enough to prevent the sump pump cycling off and on too frequently. Mechanical systems require constant flows to operate the separation equipment; a transfer pump is required to supply these flow rates
- Maximum water level of any sump containing a pump must be lower than the base of the upstream containment structure (for example, solids bunker or sludge bed floor) to ensure the solids remain dried
- Adequate access must be available around the site for machinery to desludge the system in a safe manner, and without damaging any lining.

The options in Figure 4.1 represent the main FDE systems configurations available, although there are variations on these concepts, for example, substituting an anaerobic settlement pond for a sludge bed with weeping wall.

Figure 4.1: Passive System Options: Sludge Bed with Weeping Wall

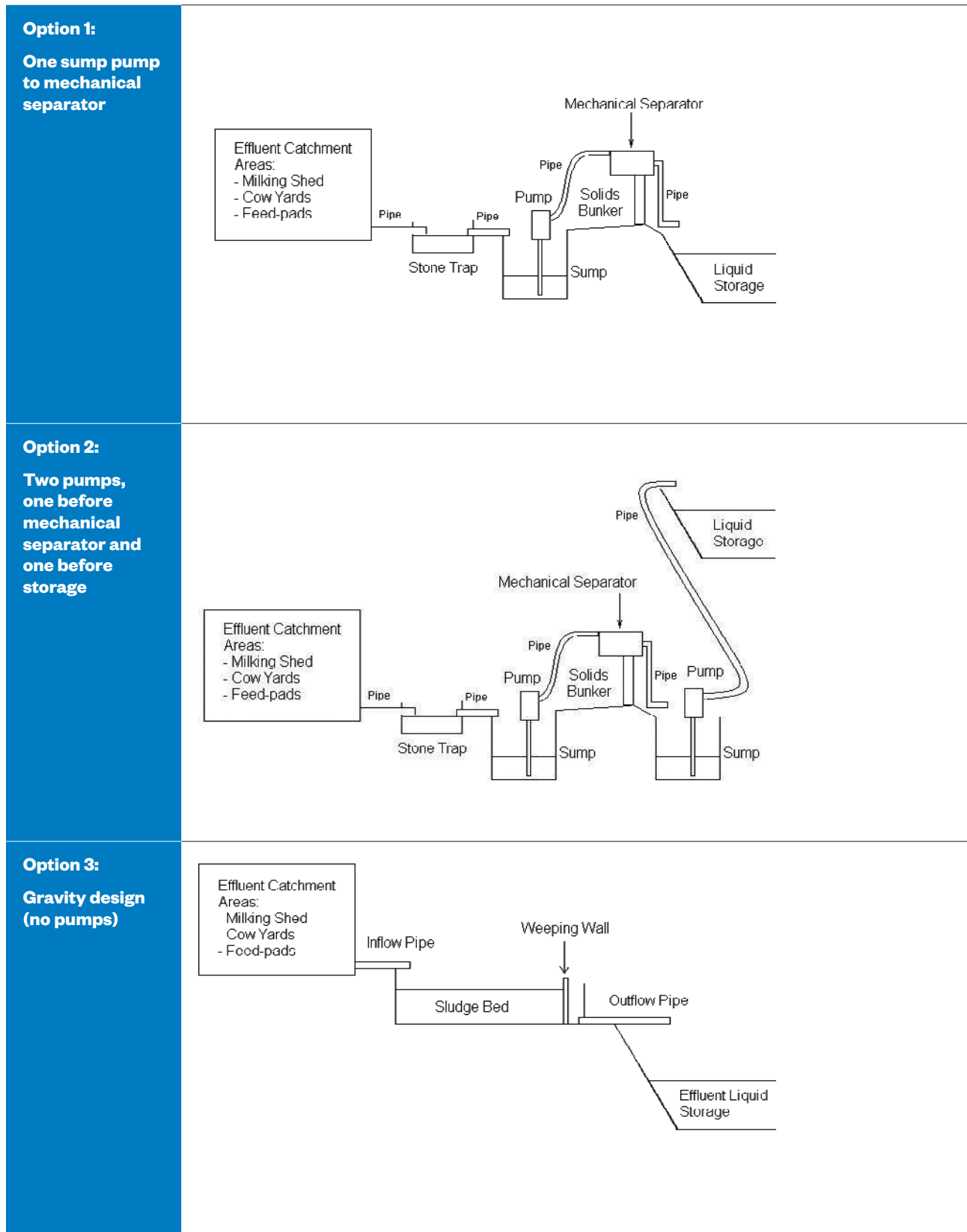



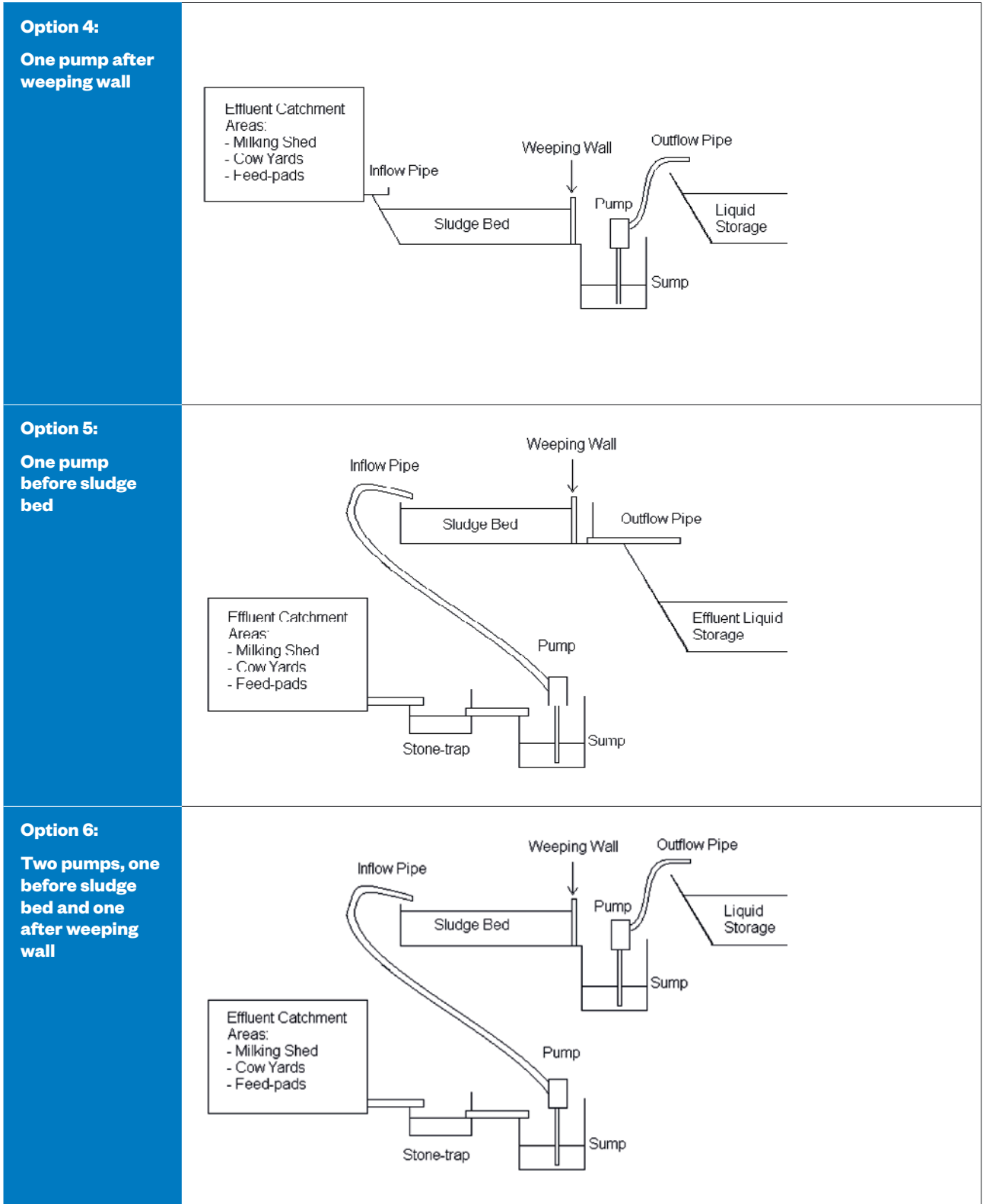

## 5. SUPPORTING INFRASTRUCTURE

MPI in their *NZCP1: Design and Operation of Farm Dairies* describes the minimum standards applicable to ensure that equipment, facilities and services at farm dairies are designed, located, constructed and operated appropriately.

While this Practice Note does not cover the design or construction of the dairy shed building where cows are milked or milk is stored, designers need to be cognisant of *NZCP1* in relation to the infrastructure that supports the milking operation. There are specific requirements for the following infrastructure elements as reproduced in Tables 5.1 to 5.3.

### 5.1 FLOORS, YARD SURFACES AND RACES

*Table 5.1: Excerpt from NZCP1: Design and Operation of Farm Dairies*

#### 4.1 Floors, Yard Surfaces and Races

- (1) All the floors of a farm dairy (i.e. in the milking, milk receiving, and milk storage areas, yards and associated storerooms and offices) must be made of concrete or a similar impervious material. These floors and yards must be:
  - (a) uniformly graded;
  - (b) be able to be readily cleaned after every milking; and
  - (c) have a fall to allow drainage to approved outlet points.
- (2) Farm races must be made of concrete for a distance of 10 m from the milk receiving and milk storage areas, and edges of the pit or milking platform. If these areas are not maintained in a safe and hygienic condition the amount of concrete race required may be extended.
- (3) All concreted areas in, and around the farm dairy must fall to a drainage point connected to the dairy effluent system.
- (4) All farm races must be free draining. Any run-off from the races must not pond within 45 m of the farm dairy.
- (5) The minimum recommended fall for yards is 1 in 50 and for other areas 1 in 80.
- (6) Larger herds may benefit from extending the concreted entry/exit races to 20 m from the milk storage room, milk receiving room and edges of the pit or milking platform.
- (7) For further information on concrete for the farm refer to the Cement and Concrete Association Information Bulletin *IB 55*, "Concrete for the Farm".

Note that the designated farm dairy area is defined as including the milking, milk receiving, and milk storage areas, yards and associated storerooms and offices.

## 5.2 EFFLUENT DRAINS AND SUMPS

Table 5.2: Excerpt from NZCP1: Design and Operation of Farm Dairies

<p><b>4.3 Effluent Drains and Sumps</b></p> <p>(1) Drains, sumps and traps must be of a sufficient size to cope with the total effluent flow. There must be an adequate fall in the drains to the drainage point.</p> <p>(2) Open drains must be constructed of concrete or another similar material so they are easily cleaned and free draining. All drains from the main sump to the effluent disposal point must be fully enclosed and impervious to moisture.</p> <p>(3) If drainage is discharged from a milking pit by either a venturi or a pump, a recess should be provided in the floor. The sides and bottom of this recess must be finished to a smooth surface and sealed to prevent any seepage.</p> <p>(4) Most drains require a minimum diameter of 100 mm, with a fall towards the draining area of 300 mm in every 25 m (1 in 80). Open drains should be rounded off at the bottom to assist with self-cleaning and prevent the accumulation of silt, gravel and weeds.</p> <p>(5) Sumps must be made of concrete or another impervious material and must be designed to be easily cleaned. Sumps must not be located within 10 m of the milking, milk receiving and milk storage areas, unless the effluent is to be pumped away on a daily basis or piped to effluent ponds.</p> <p>(6) Sumps between 10 and 20 m of the farm dairy may have a storage capacity up to but not exceeding 22,500 L and must not have a footprint exceeding 4 m in diameter or a surface area of 12.5 m<sup>2</sup>.</p> <p>(7) Sumps between 20 and 45 m of the farm dairy where storage capacity exceeds 22,500 L are permitted provided:</p> <ul style="list-style-type: none"> <li>(a) storage capacity does not exceed 100,000 L;</li> <li>(b) the structure does not have a footprint exceeding 7 m in diameter or a surface area of 38.4 m<sup>2</sup></li> <li>(c) the level is controlled to a maximum storage volume of 22,500 L; and</li> <li>(d) the structure is not utilised as the primary effluent storage facility.</li> </ul>
---

Note that the closer sumps are to the farm dairy the smaller sump volumes permitted.

## 5.3 STONE TRAPS

Table 5.3: Excerpt from NZCP1: Design and Operation of Farm Dairies

<p><b>4.3 Effluent Drains and Sumps</b></p> <p>(8) Sand traps (also known as stone traps) and associated drainage pads must be made of concrete or another impervious material and must be designed to be easily cleaned.</p> <p>(9) Sand traps must be located at least 10 m from the farm dairy, must not have a capacity exceeding 7.5 m<sup>3</sup>, and must be designed to retain sand and stones with a minimum of effluent solids.</p> <p>(10) Drainage pads associated with sand traps and solids storage bunkers must be located at least 10 m from the farm dairy and, unless 45 m from the farm dairy, must not be used to store more than 5 m<sup>3</sup> of sand trap cleanings or de-watered solids. The drainage pad or solids storage bunker must be constructed so that stored cleanings are effectively contained and any liquid drains back into the effluent system.</p> <p>(11) Sand traps exceeding 7.5 m<sup>3</sup> and drainage pads greater than 5 m<sup>3</sup> and (including weeping wall sludge beds) must be located at least 45 m from all areas of the farm dairy other than any yards.</p>
---

### 5.3.1 Stone trap design

Where FDE is to be pumped, put through a screen or placed into a lined pond, an effective stone trap is essential. Stone traps are also commonly referred to as a sand trap, grit trap or wedge.

Stone traps like other FDE system components must be constructed of impermeable materials. Typically, stone traps are wedge-shaped and made of high strength reinforced concrete that allows drive on access for a front-end loader, or an excavator, to remove the sludge. Concrete ramps down into the trap should have a slope no greater than 1:4 and be grooved or roughened to aid safe reversing out. A concrete apron placed back from the top edge of the ramp will assist in providing traction for a reversing machine with a full bucket. Deep traps greater than 1 m with a steep access grade and a short base length should be avoided.

Sizing of a stone trap is a balance between slowing the incoming flow enough to drop out most of the sand, and not slowing the flow to the point where large amounts of organic solids also settle. Internal baffles (which can be removed for trap cleaning) may assist in dropping sand while directing organic solids to the outlet.

A favoured trap design is one that allows the water level to be temporarily drawn down prior to trap cleaning leaving firmer solids to be picked up. Where gravity allows, this may be achieved by a low-level outlet with a slide gate fitted in a side wall. An alternative is to pump from the stone trap, using the likes of a septic tank vault filter fitted in a chamber to one side of the trap. Yet another option is to provide a low power mixer to the stone trap (1 to 2 kilowatts), sufficient to keep organic fibre in suspension and moving liquid through to the outlet while allowing sand and stone to settle.

To facilitate the dropout of the heavier grit and sand, the trap should be set up so that the current forms a circular flow pattern as shown below.

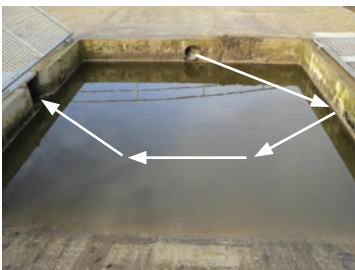

*Typical stone trap installation*

An impermeable draining pad should be provided near the stone trap to allow separated sludge to dewater prior to its removal and disposal. The runoff water must drain back into the FDE containment system. Note there are regulatory requirements covering the size and location of a stone trap (referred to as a sand trap in regulation) and draining pads as reproduced in Table 5.2.

Drain pads should be located as far as practicable from the farm dairy to minimise insect numbers around the dairy shed. The surroundings of farm dairies must be kept clean and tidy to discourage birds, rodents and insects.

## 5.4 SOLIDS BUNKERS

Where a slope screen or mechanical separator is installed, the solids separator is typically mounted on the wall of a bunker, but could also be free standing. The holding volume of the bunker needs to be appropriate to the; separator capacity, herd size and frequency at which the farm management wish to clean it out. Bunkers are usually constructed of reinforced concrete panels or of masonry block construction. Critical design factors are:

- Design sufficient strength into the walls to support the separator, platform, and at least two service personnel, plus a safety factor. Walls will be typically at least 3-metres-high
- Consider where the solids will fall. Solids that accumulate in the centre of the bunker are usually easier to cleanout
- Allow convenient access and turning area for a loader to clean out the bunker. As there is a risk of the loader bucket hitting the platform it is worth considering including a protecting cross beam to safeguard the platform
- Provide sufficient bunker floor area for the solids pile to slump out, especially from static or rotary screens subject to rainfall. The bunker floor must allow for draining back into the FDE containment system
- Provide sufficient drainage capacity. If the solids separator malfunctions for any reason and FDE is released, the floor drainage system must be able to capture the full discharge of FDE flowing from the separator, and return it to the pump sump or other contained storage. Note that any FDE discharge onto a solids pile can cause it flow immediately blocking any drain grating. Failures at solids bunkers are a significant potential non-compliance
- Seal the surface area where the solids are loaded out from the bunker onto farm vehicles such as a spreader.

A bunker of lower storage capacity may be workable if:

- Solids produced are of a higher Dry Matter percentage
- Farming operations allow solids to be removed from the bunker on a daily or similar basis
- The bunker is enclosed to minimise the effects of weather.

Providing a roof over the bunker can be a useful longer term investment, especially in wet climates. It should be noted that building consents are required for all such structures.

## 6. DESIGN CONSIDERATIONS

---

### 6.1 FARM OPERATIONS

Solids separation devices operate as part of the overall system and need to be well integrated with other FDE system components and farm operational practices, therefore:

- Mixers in pump sumps should be sized appropriately to keep a consistent slurry to the machine, for example not thin when the sump is full and thick as the level drops. A well-mixed sump assists with passage of sand through the system. Suppliers' advice should be sought on correct sizing
- Pumps should be sized by the supplier to deliver in the design range of the separation device
- Litter must be removed, typically by a separate coarse strainer at the sump, or dealt with by a chopper pump. Chopper pumps will change the fibre length and consistency and may affect the chosen screen performance.

On-farm operations have a large influence on solids separation performance. This need to be understood by the designer and require close liaison with both the farm staff and separator supplier.

### 6.2 FAIL-SAFE AND CONTINGENCY

The solids management system must be designed and configured to be fail-safe.

Points to specifically design for are:

- Blown plugs on screw presses or blocked slope screens that can quickly drop a large amount of the FDE flow into the solids bunker. Some screw press manufacturers have an option of a control system
- The return line from a screw press must be sized for the full design flow from the pump
- The sump pump and mixer should shut down in event of a solids separator malfunction, for example the sump pump and mixer could be placed on a maximum timer to prevent indefinite recycling of flow, provided sufficient storage/time is allowed to clear heavy rain events
- Sufficient solids storage and drainage capacity in the solids bunker
- In the event of a device malfunction or need for extended service, the plumbing from the sump and to the pond should allow the separator device to be simply bypassed (for example, by switching a cam lock connection).

### 6.3 COST COMPARISON

Determining relative costs between different solids separation options can be difficult because they depend on many site factors, such as whether topography allows gravity fall options. Furthermore, different systems produce different solids dry matter outputs which will affect manure storage and spreading.

A cost comparison without reference to the whole farm system, including solids disposal, is not recommended. Similarly, it cannot be assumed that passive or "simpler" systems such as ponds or weeping walls will necessarily be less costly than mechanical systems. The costs of purchase, installation, operation, maintenance, as well as the whole-of-life costs, are very relevant when making system comparisons. Therefore, the system designer needs to undertake their own comparative cost analysis based on the options best suited to the individual site and the farm operations.

A supply condition of mechanical separator (including static screens) should always be a commissioning by the supplier and a maintenance period of at least six months. A service contract for two to three years where the supplier meets the cost of servicing and parts, provided the farm owner meets their obligations of cleaning out stone traps, sumps et cetera, should also be considered.

## 6.4 USE OF SCREENED FDE IN PIVOT IRRIGATORS

Screened FDE is sometimes put directly through farm pasture irrigation systems, in contrast to using a dedicated FDE irrigation system. This could be with or without dilution with clean irrigation water. Where FDE has been used through pivot irrigators a number of users have experienced blockage problems with screened FDE. Short fibre remaining in the effluent can affect the water distribution by building up on the cages of the irrigator nozzles, blocking non-rotating nozzles, or stopping the rotation of sprays. Anaerobic pond effluents have also been reported to cause sliming with similar effects.

Researchers have suggested that systems perform better when the waste is dispersed to pasture within three to five days and/or stays aerobic. This could be achieved, for example, by pumping FDE to pond storage only on days when there is insufficient available soil water deficit to allow irrigation. Some research suggests macro nutrient nitrogen, phosphorus and potassium levels are better preserved with aerobic systems, and the incidence of foul odours are reduced.

Advice from the irrigation equipment supplier should be sought when irrigation of FDE through pivot irrigators is proposed. It may be that an additional fine screening step will be required in the system. A number of manufacturers are undertaking research on improved primary screening and will lead to improved pivot irrigator operation in the future.

## 6.5 OTHER TECHNOLOGIES

This Practice Note comments on systems in common use at the time of writing. Management of dairy manures is a developing area. The New Zealand rural equipment industry is undertaking extensive research into developing both enhanced and new systems, especially around fine screening for enhanced solids removal. Therefore, designers should make their own assessment of the technologies available at the time.

# 7. SUMMARY

To provide a generalised comparison, the following table compares key common design and operational characteristics between the most widely used solids separation systems available.

Table 7.1: Comparison of Solid Separation Systems

System	% DM in solids by mass (after)	Footprint	Mechanical components	Operational labour input	Typical maintenance and parts	Power usage	Water usage	General tidiness	Potential for difficulties
<b>Anaerobic Settlement Ponds</b>	Crust semi solid, general contents thin slurry <4%	Large pond area required, 4.7-6.5 m <sup>2</sup> /cow (varies with region temperature)	No pump required, (Transfer pump required if gravity fall not available)	Day to day minimal. Maintain solids filter to effluent storage pond if present Periodic (approx. annual) a major cleanout exercise required	Nil	Routine nil. Periodic substantial machine time to agitate, clean out and spread slurry	Nil	Large storage of anaerobic manure	Spreading of odorous slurry. Damage to pond liner during desludging. Sliming of irrigator nozzles
<b>Sludge Bed with Weeping Wall</b>	Variable. Depends on retention and input material. 20-30%	Large surface area required 1.5-2.0 litres/cow/ day	No pump required (transfer pump required if gravity fall not available)	Day to day minimal, some installations require clearing along wall face to maintain flow.	Low. Replace timber wall battens as required (5-yr. minimum life expected in some setups)	Routine nil. Periodic substantial machine time to clean out and spread slurry	Wash down wall panel when sludge bed emptied	Large storage of anaerobic manure	Spreading of odorous slurry. Damage to pond liner during desludging. Blockage of weeping wall



System	% DM in solids by mass (after)	Footprint	Mechanical components	Operational labour input	Typical maintenance and parts	Power usage	Water usage	General tidiness	Potential for difficulties
<b>Static Slope Screens</b>	7-11% initially off screen. Solids contain free water and will continue to leach	Small, solids bunker governs size	Effluent transfer pump. Wash water system. Timers. Solenoid valves	Variable depending on the wash system and FDE input stream. Some installations report weekly wash needed, others only every few months	Wash system	Low power required to provide 3 Bar pressure to wash system (nil if feed from farm supply).	Low typically <100-200 litres/cycle depending on nozzle selection	Good, some manure encrusted around screen itself, solids leach as still high moisture content	If screen overloads or blinds, effluent spills out into solids bunker
<b>Rotary Drum Screens</b>	10-15%. Solids contain free water and will continue to leach	Small, solids bunker size governs. Machine is larger than equivalent screw press	Effluent transfer pump. Electric motor. Gear box. Rotating drum. High pressure wash	Weekly visual check. Annual service check of drive	Bearings	Low (relative to screw press), nominal 1.5kW for 50m <sup>3</sup> /hr capacity	Wash water up to 400 litres/hour depending on drum size and loading	Good, some manure encrusting around screen, solids leach at high water	Blinding of screen causing FDE to flow to bunker
<b>Inclined Augers</b>	22%+	Small, solids bunker size governs. Machine is larger (approx. 3 m long than equivalent screw press	Effluent transfer pump. Electric motor. Gear box. Rotating auger. Back pressure	Weekly visual check. Replace auger facings possibly up to 2-3 times per year. Annual service including check of drive	Some installations report high wear on auger facings and screens	Low - for example 4kW for 72 m <sup>3</sup> /hr capacity	No specific wash water required	Good, solids leach at still moderate moisture content	Auger facing wear and screen damage, resulting in downtime

System	% DM in solids by mass (after)	Footprint	Mechanical components	Operational labour input	Typical maintenance and parts	Power usage	Water usage	General tidiness	Potential for difficulties
<b>Horizontal Screw Press</b>	30–40% Solids dry, no free water can be wrung by hand	Small, solids bunker size governs. Machines are small relative to capacity	Effluent transfer pump. Electric motor. Gear box Rotating auger. Back pressure system	Weekly visual check May need seasonal adjustment of back pressure. Annual service check of gearbox and drive Brushes on auger may need replacing 2–3 yearly	Brushes	1.5kW for 20 m <sup>3</sup> /hr. capacity	No specific wash water required	Excellent, solids dry and non-leaching, all FDE contained in machine.	Loss of plug will spill FDE to bunker. Excess back pressure may stall motor.

**Notes:** This comparison excludes reference to FDE pumps for land irrigation. All mechanical options will require a transfer pump to feed a solids separator irrespective of its type but are not considered as part of this comparison.

# PART 3

## **UNDERPASSES**

---

# 1. INTRODUCTION

---

A stock underpass is an important farm infrastructure asset that allows the passage of stock beneath a road, or railway, while allowing unhindered movement above. While it is a major capital outlay, once in operation an underpass provides major benefits by reducing safety risks, travel delays and inconvenience for both farm owners and road users. There are also environmental and animal health benefits from stock not being held on races while waiting to cross.

Environmental considerations round the operation of the structure must be identified during the investigation phase and solutions developed as part of the underpass design, rather than leaving these to the contractor or farm owner to consider at a later time. Critical to environmental effectiveness is a drainage system that captures and manages any Farm Dairy Effluent (FDE) that might collect in the underpass. Minimising the amount of storm or ground water entering the underpass is also important. Animal welfare and stock flow factors must be considered carefully when designing the approach ramps and floor of an underpass.

Underpasses are available in a range of shapes, sizes and construction materials and can be adapted to meet specific site conditions and operational use. Existing structures such as road bridges may also be modified to provide passage for stock under the road.

Underpass structures need to meet a number of legislative requirements, notably the Building Act 2004 (BA) and the Resource Management Act 1991 (RMA), require consents, and structural design from a Chartered Professional Engineer (CPEng).

Each local council referred to as a Territorial Local Authority (TLA), or the NZ Transport Agency (NZTA) in the case of national highways, has their own policies and procedures on the design, construction, operation, maintenance and inspection of underpasses. Authorities that administer road reserves, across which underpasses are built, such as district councils, are also referred to as a Road Controlling Authority (RCA). They require owners of underpass structures to enter into legal agreements that will state the responsibilities and costs to be borne by each party. The construction of an underpass generally follows three main RCA processes; road opening, deed of grant registered against the property title, and building consent. The installation of underpasses in railway reserve or under railway bridges is outside the scope of this Practice Note.

Farm owners should allow sufficient lead time for their new underpass as the process of arranging agreements and investigations through to design, approvals, and construction can take at least six months. Weather can also impede progress.

## Key Points

- Each RCA has their own policies and procedures which will need to be followed, including:
- Allow sufficient time ahead of when underpass is required, and allow for delays
- Professional engineering guidance is required for design and construction monitoring
- Detailed survey and investigation of the underpass crossing site is critical
- Environmental effects mitigation and effective drainage must be incorporated into the underpass design
- Underpass width, stock flow, approach ramp slopes, and surfacing are key design considerations and can affect animal health
- Different types of underpasses will suit different sites – suppliers should be consulted
- Only experienced contractors should be engaged to undertake installation.

## 2. PRELIMINARY

---

It is important that both farm owner/client and designer develop an agreed understanding on all the performance requirements of the new underpass. This is likely to evolve through discussions with the RCA, regional council and other affected parties. There will be an expectation from the farm owner/client that the structure will provide good stock flow with minimal maintenance, possess long-term durability and be continuously available for use. The RCA on the other hand will have an expectation that road users will be provided long-term safe and uninterrupted passage at minimum cost. Affected parties will include service providers, for example electricity and telecommunications providers, who have their assets located in the road reserve. These and other various parties must be consulted at an early stage.

### 2.1 RCA REQUIREMENTS

If a stock underpass is to pass through a road reserve then permission will first be required from the governing authority, either the local authority for local roads or NZTA for State Highways. The governing RCA bodies will require payment for the approval process as well as guarantees that the roads will be reinstated to a certain minimum standard. They may require a bond in order to recover any costs from the farm owner and their agents, including contractors, if satisfactory completion is not provided.

All RCAs have slightly different procedures and it is necessary at the outset to check what these specific requirements are. Most RCAs have their policies and approval processes, including application forms, on their websites.

RCAs will generally require:

- That the land on both sides of the road reserve be owned by the same owner. (If there are two owners, but one owner leases land to the other, there is the potential difficulty if one owner sells, of the sale leaving a redundant underpass. Who then takes the responsibility for maintaining or removing it?)
- The appropriate structural design is to be arranged (and paid for) by the owner and will be suitable for the safe crossing of future traffic loading
- The landowner enters into formal binding agreements with the RCA, for example Construction Agreement and Use Agreement
- The underpass meets specific design standards for structures consistent with its intended use and “Importance Level (IL) (as specified in the NZTA *Bridge Manual*)
- The structure be designed by a CPEng and constructed by an experienced contractor in accordance with the Building Act 2004 and the Building Regulations 1992
- That any resource consents required under the Resource Management Act 1991 (RMA), are obtained by the owner from regional council. Note that in addition, some district councils may require a land use consent depending on issues such as, the volume of earthworks and separation distances to dwellings
- The underpass construction is commenced only after receiving an approved Corridor Access Request and a Work Access Permit from the RCA
- The installation meets the requirements of the Health and Safety in Employment Act 1992. A Site Safety Plan will need to be submitted to the RCA for acceptance, prior to any work commencing in the road reserve
- The underpass contractor carries out the work under an RCA approved Traffic Management Plan that conforms to the Code of Practice for Temporary Traffic Management (COPTTM)
- Installation of any owner’s ancillary services across the road (for example, water pipes, electricity supply) is approved under a Deed of Grant for private services

- After construction completion, the RCA will manage the structure as a bridge on their roading network
- The underpass structure will be operated by the landowner in a safe manner and be properly operationally maintained at their cost.

The Stock Crossings Working Group of the Road Controlling Authorities Forum (New Zealand) Incorporated has produced their “*Best Practice Guidelines for Stock Crossings*” as guidance (refer to References section of this Practice Note). From this document a flowchart which demonstrates the typical RCA approval process is reproduced in Figure 2.1.

## **2.2 COST APPORTIONMENTS, AGREEMENTS AND OWNERSHIP**

### **2.2.1 Who pays?**

If it is primarily the land owner who wants the underpass, then they will generally have to pay all the costs involved. However, subsidies to the landowner from the RCA may be available but will likely depend on:

- Whether the RCA or farm owner initiated the enquiry
- RCA subsidy policies
- RCA’s budget availability status
- Annual average daily traffic counts (AADT), usage and IL of the road.

If the underpass is subsequently removed then this will usually be undertaken by the RCA with costs, including road reinstatement, borne by the landowner who takes back ownership of the physical structure itself.

### **2.2.2 Legal arrangements**

Legal agreements will be required. A Memorandum of Encumbrance which ties the structure to the adjoining land, or a Deed of Grant containing standard conditions, are methods which may be used.

Most RCAs prefer to take over ownership of the underpass structure and will meet the repair cost of any structural defect, provided it is not attributable to the landowner’s activities. Any maintenance and repairs required, such as fencing and drainage, will usually be at the landowners cost and covered by a separate underpass use agreement.

Figure 2.1: Flow Chart for Underpass  
 (from: RCA Forum – Best Practice Guidelines for Stock Crossings App 8)

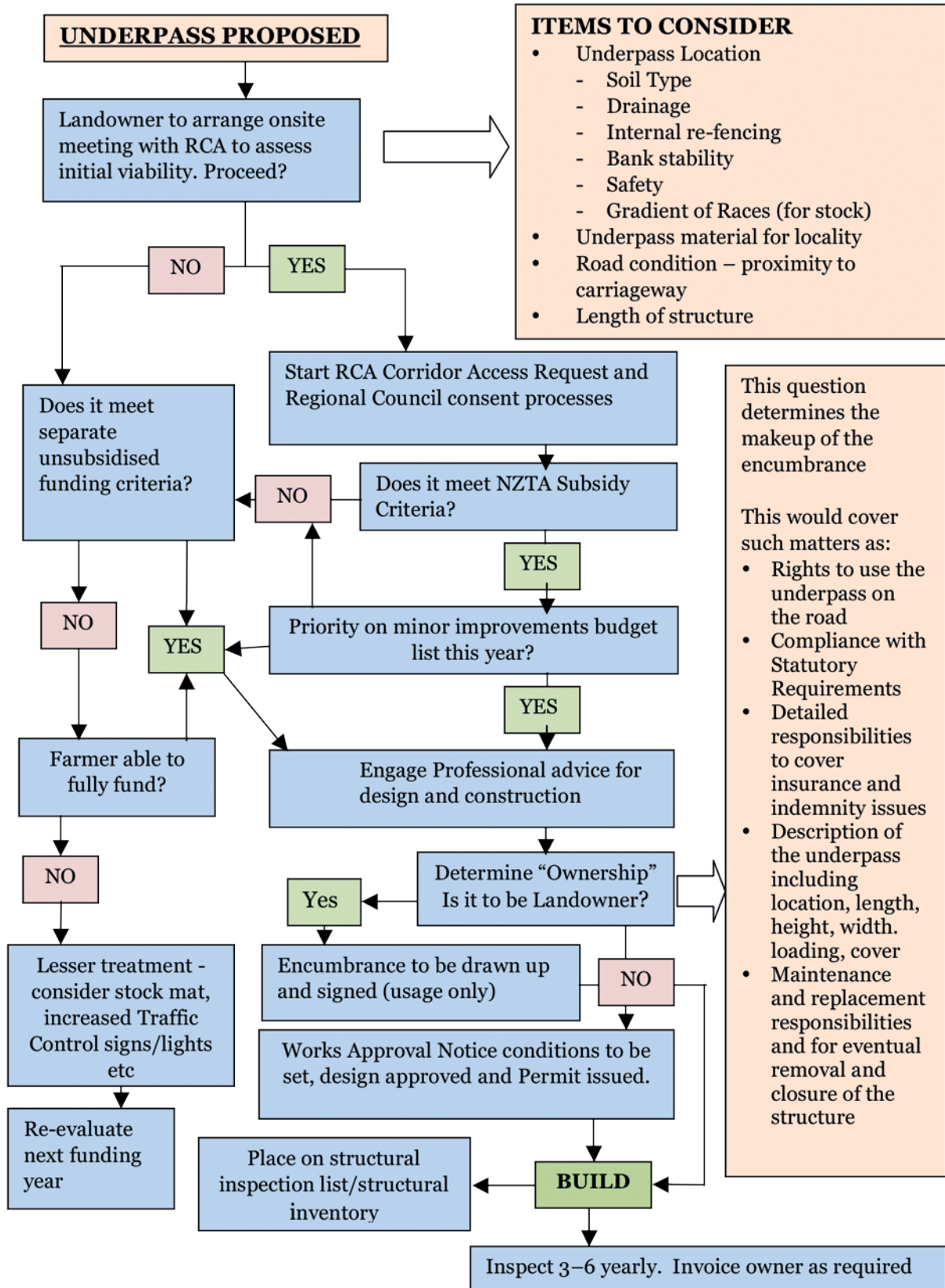

## 2.3 PROGRAMME

Obtaining all the required approvals prior to underpass construction can take many months and farm owners need to allow sufficient lead time ahead of when they intend first using their new underpass. There are many factors that can affect the programme including:

- Extent (and outcome) of consultation required with affected parties
- Manufacturing schedules of underpass product suppliers
- Weather, as some sites will be unsuitable for underpass construction in winter
- Road bypass availability during construction
- Conformance with RCA approval processes
- The RCA may restrict construction to certain times of the year to reduce road user inconvenience
- Availability of specialist contractors and equipment (for example, crane) for the site location.

For general guidance, Figure 2.2 provides a typical timeline.

Fig 2.2: Timeline for the Installation of a Stock Underpass (Typical)

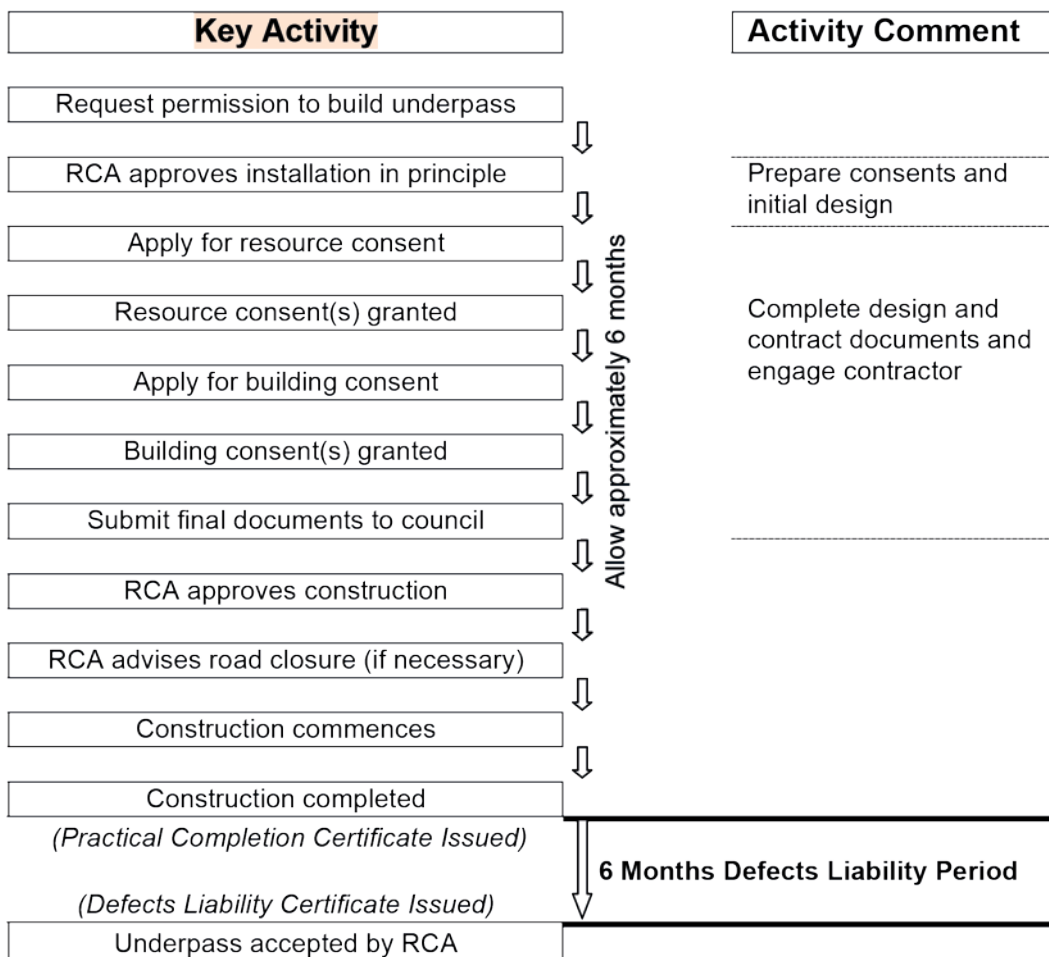



## 2.4 DOCUMENTATION

Table 2.1 provides a list of typical documents that may need to be supplied to the RCA.

*Table 2.1: Documentation Required (Typical)*

Documents to be provided to RCA
<ul style="list-style-type: none"> <li>• Certificate of Title for each property serviced by the underpass</li> <li>• A geotechnical (foundation) report giving evidence that the underpass sub-base is sufficient to support the structure</li> <li>• Unsigned schedules from conditions of contract (NZS 3910)</li> <li>• Underpass design drawings and specifications (site, drainage, cross sections, roading) from a CPEng.</li> <li>• Underpass manufacturers drawings and specifications</li> <li>• Building consent and Project Information Memorandum</li> <li>• Resource consent(s)</li> <li>• Designer(s) producer statement(s)</li> <li>• Signed construction agreement</li> <li>• Signed use and subsoil lease agreement</li> <li>• Proof of contractor's insurance</li> <li>• Contractor's Health and Safety plan</li> <li>• Corridor Access Request and a Work Access Permit</li> <li>• TMP completed by a qualified Site Traffic Management Supervisor (STMS)</li> <li>• Bond (if required)</li> <li>• Any further conditions the RCA may apply</li> <li>• Fees payable on application</li> </ul>
Utility provider documentation
<ul style="list-style-type: none"> <li>• Utility provider documentation</li> <li>• Telephone (may be more than one)</li> <li>• Energy (for example electricity and gas)</li> <li>• Water</li> <li>• Sewer</li> <li>• Gas</li> <li>• Land Information New Zealand</li> </ul>

## 2.5 NEED FOR PROFESSIONAL ENGINEERING GUIDANCE

Installing an underpass requires completion of a number of tasks including; surveying, geotechnical investigations and materials testing, resource management planning and consenting consultation with various parties, structural design, construction drawings and specifications, estimates, tendering, construction contract management, testing and measurement, and preparing producer statements at completion.

As this process can be complex a competent designer should be engaged. There are a number of design and construction approaches that will provide this as shown in Table 2.2.

*Table 2.2 Design and Construction Approaches*

Design and Construction Approaches	
<b>Design then Build</b>	A structural designer designs the underpass, and (on behalf of their client) and administers a contract to build it
<b>Design and Build</b>	A structural designer is engaged by their client for both the design and build of the underpass
<b>Alternative</b>	A competent civil engineering contracting firm may manage the project, but contract out required specialist professional inputs where these are not available “in-house”.

Constructing stock underpasses and completing ancillary works is a specialist activity and should only be undertaken by an experienced civil engineering contractor.

Like most other built structures, the design of each underpass structure and their foundations must be carried out by a CPEng. A Producer Statement (*PS1 – Producer Statement – Design*) signed by this engineer accompanies the building consent application.

Underpass construction is best administered as a contract under, for example, NZS 3910 Standard Conditions of Contract for Building and Civil Engineering Construction. This standard defines the various roles and responsibilities of the principal, contractor and Engineer. The construction industry promotes the use of NZS 3910 in its standard form which is an equitable form of contract that is well tested, fair and provides certainty to all parties. NZS 3910 is further explained in *Practice Note 21* Part 1, section 9.

The construction is monitored by a person competent in this role, usually by a CPEng or someone working under their direction. At project completion, they will complete a *PS 4 – Producer Statement – Construction Review* to confirm that the structure has been built as detailed in the project drawings and specifications. As-built drawings and engineering test results on the excavated base below the underpass will also usually be required. Following construction and upon providing all completed documentation required by the RCA, a Code Compliance Certificate will be issued. Again, this process can be complex and is best handled by a project manager.

## 3. INVESTIGATIONS

---

### 3.1 LOCATION

At the outset, it is preferable to determine both the most likely position as well as an alternative crossing point option. Selection of the most suitable underpass site is likely to be a compromise that considers the following desirable factors:

- The land on both sides of the road reserve is in the same ownership
- No likelihood of flooding
- The underpass base level will be above the highest known ground water table level
- The base has suitable foundation bearing capacity to support the structure
- A gully at right angles to the road with a continuous downslope over its length so as to avoid ponding within the underpass
- The location and operation of the underpass, ramps and access races will not affect surrounding surface drainage
- A straight section of road with good horizontal and vertical geometry where there is a low risk of errant vehicles leaving the highway and impacting the underpass
- The new underpass will cross the road without altering the horizontal or vertical alignment of the carriageway
- The profile of the underpass roof will not protrude up into the pavement or surface profile of the road shoulder.

Other site location considerations include:

- A safe alternative road crossing point is available should the underpass be temporarily unavailable
- Alignment with existing farm race network
- There are no significant underground services in the road corridor that are costly to relocate (for example, fibre optic cables)
- Availability of a natural gully alongside the road, which will reduce the quantity of excavation required
- Presence of trees, road culverts, power poles and other physical features
- Sufficient separation distance from dwellings and other certain buildings
- Availability of power, if required (to operate sump pump and lighting)
- The underpass is able to cross at right angles to the road (to minimise underpass length and cost)
- Availability of suitable bedding and backfill materials on site
- Proximity of the underpass effluent sump to the Farm Dairy Effluent (FDE) storage and irrigation system
- Sufficient area around the underpass site to construct a temporary bypass during construction
- The proposed underpass does not encroach on a known archaeological site.

The RCA may have specific policy requirements that could affect final location and configuration, for example:

- Minimum underpass length allowable; for example, some RCAs may require the underpass to span the full width of the road reserve, while others may allow it to be reduced if the risks to road user safety is mitigated, for example, with safety barriers
- Provision for pedestrians and cyclists
- Side protection requirements, for example, approved guard railing
- Minimum depth of basecourse cover over the top of the underpass unit for example 100 mm
- Rationalisation of existing access places along the property road frontage required
- Consent required to alter a water course
- Location does not compromise foreseeable future work (for example, road widening or realignment)
- The stability of any cut/fill slopes supporting the road is not compromised
- Minimum clearance distance available between the edge of the carriageway and the end of the underpass
- The underpass is able to be drained and kept free of water (and effluent) at all times.

## 3.2 SURVEY

RCAs usually require detailed plans of the proposed stock underpass site as part of the required application documentation. Similarly, the designer needs to know the position and level of all physical features so they can optimise the road crossing position and develop construction plans. This is best achieved with a detailed topographic survey that picks up features such as gullies, water courses, culverts, gates, fence lines, races, road centreline, pavement edges, accesses, trees, and road corridor utilities.

An experienced engineering surveyor can confirm where the legal boundaries are and what the land ownership arrangements are. Legal easements and underground utilities that might affect the underpass location can also be investigated.

## 3.3 GEOTECHNICAL INVESTIGATION

As with any project that involves earthworks, there is a need to know what the geological and engineering properties of the soil are. This is best undertaken by a geoprofessional. The following stepped approach is similar to that described in *Practice Note 21* Part 1, section 4 for the site investigations for FDE ponds.

*Table 3.1: Investigation Steps for Underpasses*

<b>Investigation Steps for Underpasses</b>	
<b>Step 1</b>	Assess and record the site's overall terrain. Need to note slope stability, surface water, trees, other features
<b>Step 2</b>	Excavate test pits (at least one on each road side) to at least 1 m below the proposed base of the underpass and determine materials present. Undertake continuous scala penetrometer testing down through the test pit to infer foundation bearing strength. Determine highest ground water level. Note any collapsing of the test pit sides as this may be an indicator of cut slope stability issues
<b>Step 3</b>	Log and photograph soil materials present and take representative samples of potential fill materials for laboratory testing
<b>Step 4</b>	Prepare a geotechnical report

### **Checklist: Site Selection**

- Base of the underpass is above ground water level
- Extent of earthworks cutting for underpass and ramps able to be minimised
- Base area has sufficient soil bearing capacity
- Site drainage will be unaffected (or can be remediated) by the works
- Power available to the site
- Poned FDE can be captured, stored and irrigated
- Land on both sides of the road is in the same ownership
- RCA accept proposed location, design and construction.

## 4. UNDERPASS STRUCTURE OPTIONS

There are a number of different underpass structures available in a wide range of sizes from suppliers throughout New Zealand. Precast concrete is the most popular type but there are other options in alternative materials such as galvanised steel and aluminium.

Underpasses are usually assembled by bolting or tying together units of standard length either partially in the factory, or on site depending on the site conditions. The limiting issue is often the accessibility for lifting equipment of the required lifting capacity to the underpass site. Accessibility challenges can include; soft ground conditions, ground slopes, turning circles, gate widths, overhanging trees, overhead powerlines, and drainage features.

Water pipes, power cables and other on-farm services are best contained underground within PVC ducts that are placed parallel to, and outside of the underpass wall, and exit through the wingwalls. This design arrangement reduces the likelihood of damage to services by vehicles or stock.

### 4.1 CONCRETE

Precast or *in situ* poured concrete underpasses have some advantages in that they can be engineered to situations where a minimum pavement cover over the top of the underpass is desired. An example of this is where a high ground water level would otherwise restrict the available opening size of the underpass.

Concrete floors can be shaped to assist in channelling FDE to a cut-off trench, sump or similar FDE containment facility.

*Figure 4.1: Precast concrete underpass unit options*

*Top Left - Twin U culvert*

*Bottom Left - Box culvert, under construction*

*Right - U culvert and base*

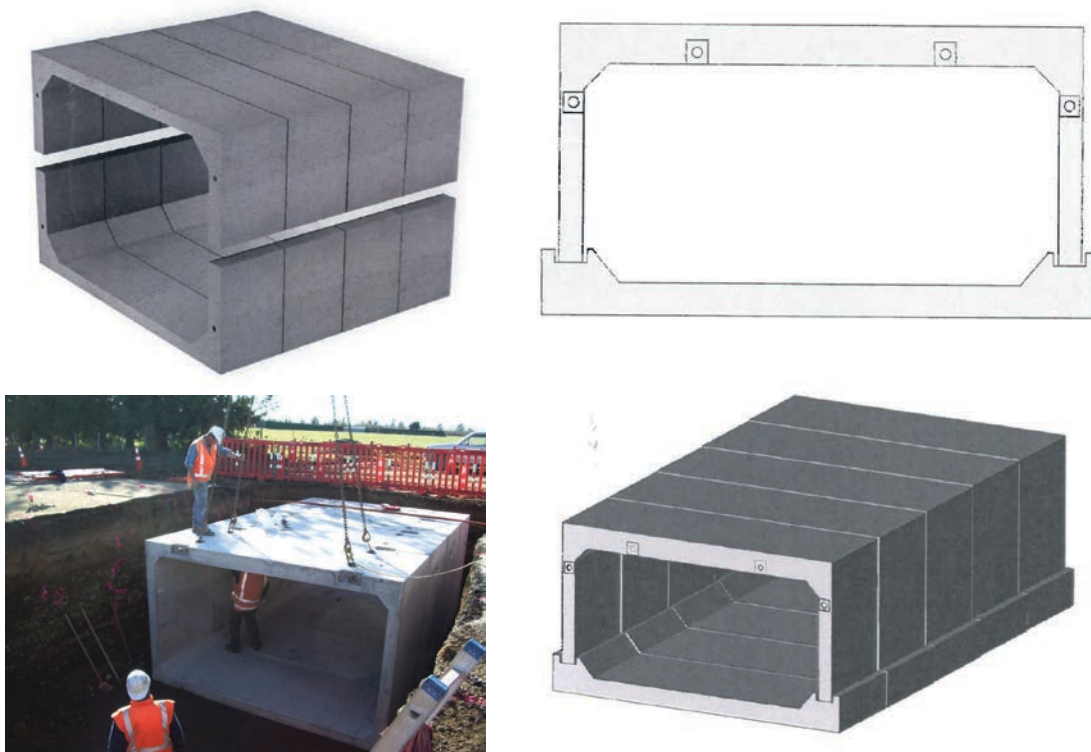

Box culverts can be specifically designed to provide the required foundation strength under the road pavement. As the internal base of the box is the floor of the underpass, boxes provide some construction savings by eliminating the need to pour an *in situ* base. Interconnecting precast wingwalls and headwalls are available. Starter bars can be cast into end units so as to tie into *in situ* poured wingwalls or apron floor slabs. Various joint sealing options are available.

One advantage that precast concrete units have over galvanised steel or aluminium underpass options is that less width and depth of excavation and backfilling is required. For safety, the pouring of concrete floors into steel or aluminium units require cutting batters further back, which is not such an issue for the premade concrete units.

For difficult or unusual sites, an *in situ* poured concrete underpass may be an option. However, it will be more expensive than other precast options because of the one-off nature of its design and construction.

While concrete underpasses have a higher capital cost than other options, they are considered to be the most resilient and longest design-life option where FDE and groundwater needs to be contained while still providing durable interior surfaces for stock and vehicle passage.

## 4.2 STEEL AND ALUMINIUM STRUCTURES

### 4.2.1 Corrugated pipe

Buried helically corrugated metal structures, typically corrugated galvanised steel or aluminium pipes, are defined in AS/NZS 2041 as Class 1 and are manufactured with continuous locked seams with annular corrugated ends. The sections of pipe are joined by coupling bands. They are suitable for smaller structures with standard spans up to 1.2 m although up to 3.6 m is available on request. However, because of their relatively small diameter, Class 1 structures are unsuitable for stock underpasses.

### 4.2.2 Multiplate systems

Class 2 structures are defined as steel and aluminium multiplate structures, which are assembled by bolting together corrugated galvanised steel or aluminium plates to create a continuous structure. They do not require a coupling band and have a span from 1.5 m up to 6 m and are manufactured in lengths to suit.

Key features of multiplate structures are their durability, and the lightness of the plate sections which allow; ease of handling, relatively quick construction with minimal plant, and onsite assembly using bolts. They can be a good option for remote areas where site access is difficult and partial pre-assembly of lengths can reduce installation time.

Aluminium plate structures are manufactured from a marine grade aluminium alloy, which offers better resistance to corrosion in both fresh and marine water environments than galvanised steel. When mechanically damaged the aluminium oxide coating surface reforms. In contrast, galvanised steel structures in abrasive stock underpass situations will continue to corrode slowly, although this can be reduced by the use of epoxy coatings.

Multiplate systems are not suitable however for locations prone to high water tables or groundwater inflow as the plates do not provide sufficiently watertight joints. Not only does the groundwater need to be cut off from flowing in through the wall but FDE must not be able to flow out through the plates and potentially into groundwater.

A poured concrete floor within the structure should be included to provide a durable surface for stock and vehicles to travel on. Under the floor, at the lowest point of the internal cross section, a subsoil drain within a bedding of free-draining granular fill should also be installed to provide effective drainage capture.

All buried corrugated metal structures derive their strength through interaction of the surrounding backfill while providing important side drainage. Competent design and construction monitoring is essential.



*Galvanised steel corrugated multiplate culvert underpass under construction*

Multiplate typically requires a minimum of 900 mm of cover and the approved backfill must be carefully selected and compacted so to provide support to this flexible structure while avoiding damage to the lightweight plates. The person doing the construction monitoring needs to ensure that assumptions made at the design stage match on site realities and that backfilling is in accordance with the manufacturer’s specifications. Only a manufacturer approved contractor should be installing these types of structures.

*Figure 4.2: Typical Cross Section for Multiplate Structure*

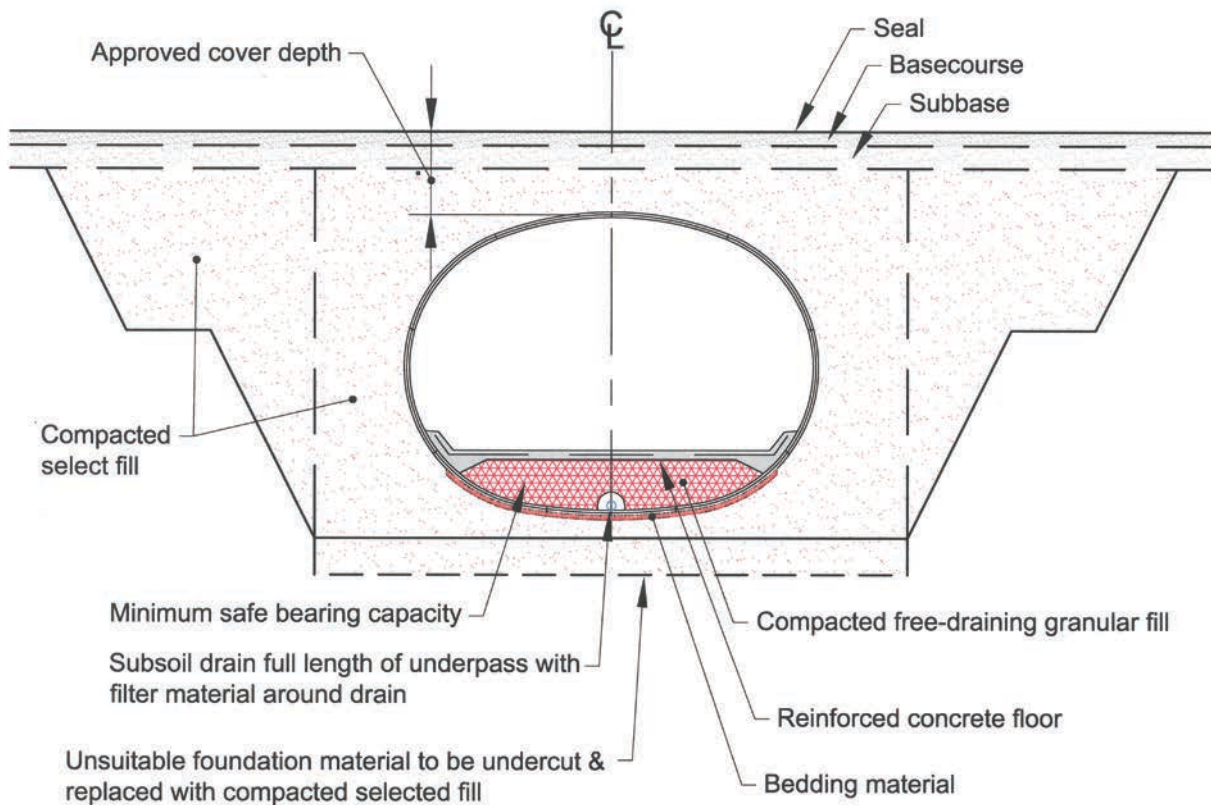



### 4.3 MODIFICATION TO AN EXISTING BRIDGE

Where there is sufficient clearance under an existing bridge to construct a dairy race this may prove to be a cost-effective option. However, the challenge will usually be what to do with the stormwater and FDE that collects on the race as there is a risk that it will flow into an adjacent waterway or to groundwater. A specially designed sump system is recommended that pumps the contained stormwater/FDE away to storage and irrigation.

Figure 4.3 provides an example design of how this could be accomplished.

Figure 4.3: Example Design for an Underpass beneath an Existing Bridge

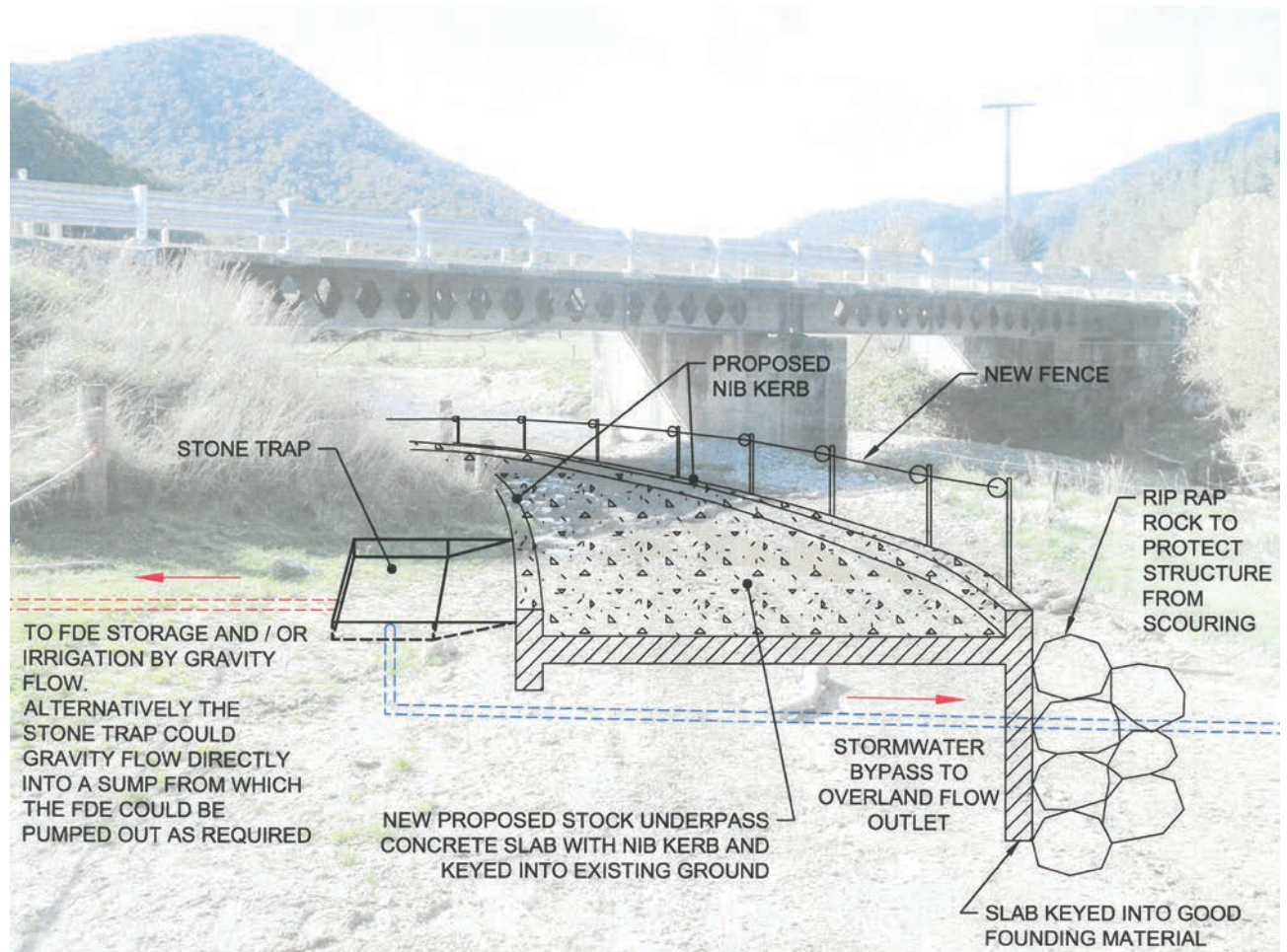

### 4.4 GENERAL COMMENTS

Many suppliers offer generic drawings and specifications to be included with building consent applications. While these will be satisfactory for many sites, they may not be for others and so there is a potential trap here. Often generic drawings and specification assume the underpass base is founded on “good ground” as defined by NZS 3604, or that the subgrade allowable bearing pressure is 100 kPa. Where the ground is not “good” then it will be necessary for the structural designer to analyse the standard foundation detail supplied, and determine whether it needs to be modified to suit the particular site. Figures 4.4 and 4.5 illustrate typical underpass plan and cross sections.

Figure 4.4: Example Underpass Design – Plan

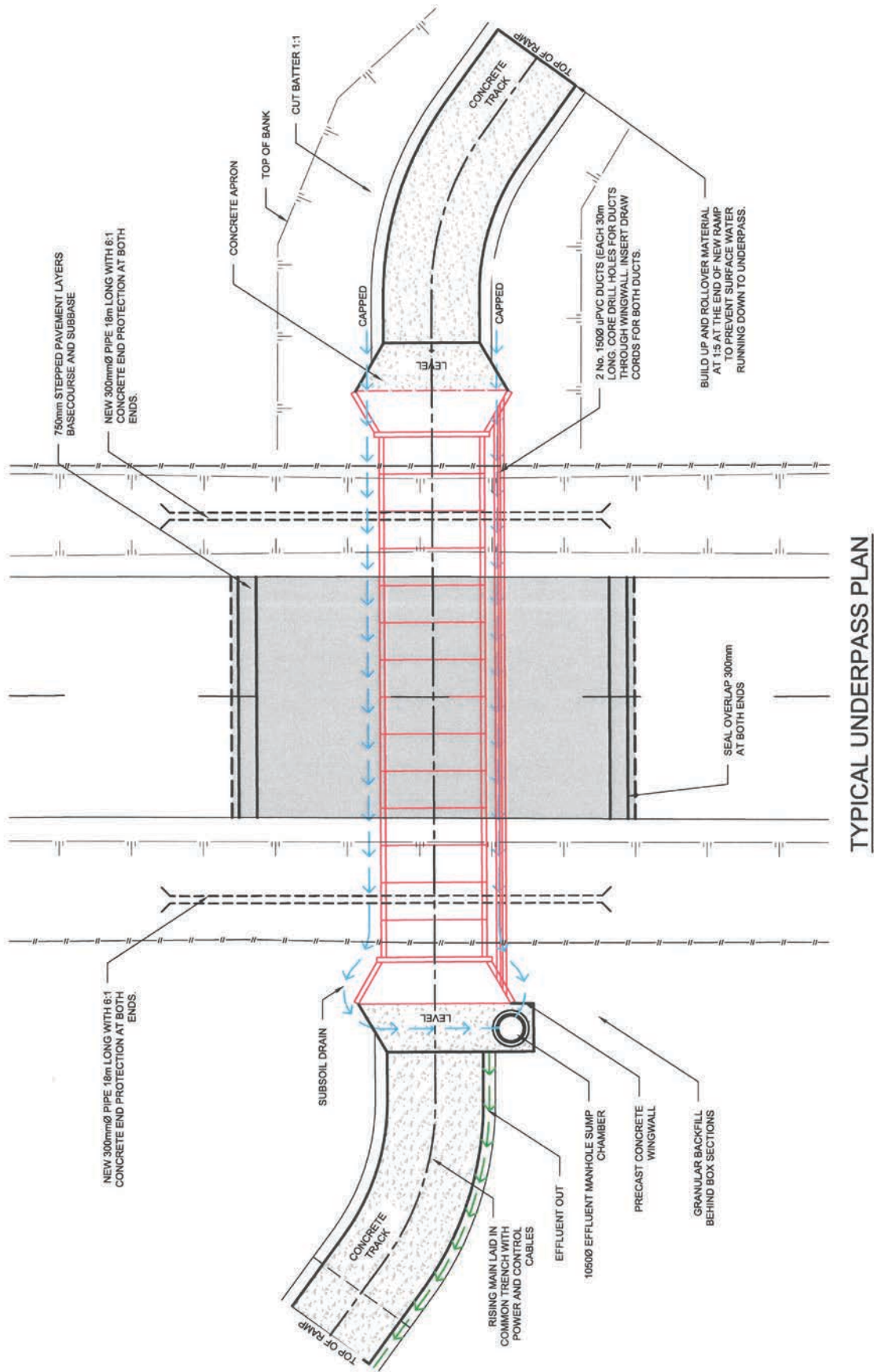
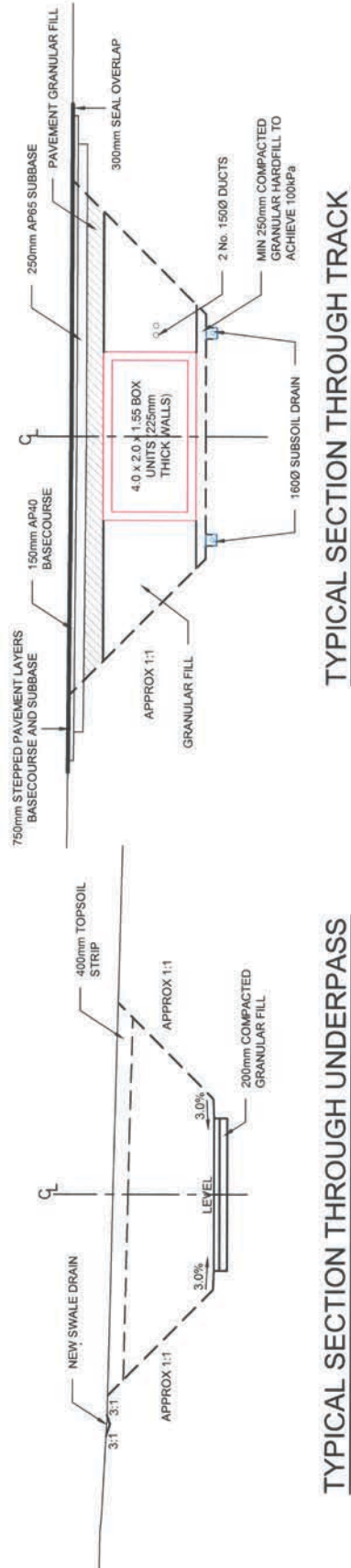
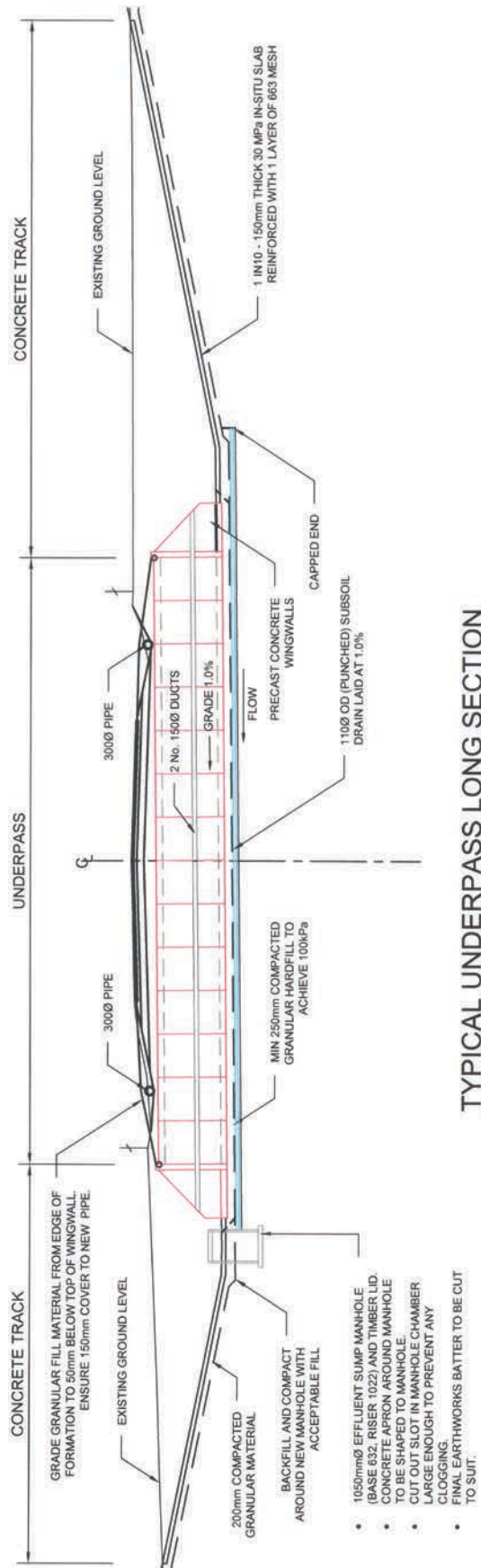

Fig 4.5: Example Underpass - Sections



## 5. DESIGN

---

### 5.1 DESIGN INTRODUCTION

A stock underpass structure must be designed to meet the multiple and, at times, competing requirements of the RCA, road users, utility owners and the farm owner. Their design and construction needs to be of a high standard to ensure that not only is it effective in form and function but allows safe passage of road users for many years with minimal maintenance. A rigorous design, construction, and completion process is required to achieve this.

The designer's drawings need to show:

- A plan, long section and sections through the underpass, for example as shown in Figures 4.4 and 4.5
- Gradients of approach ramps, location of the top and bottom of any side batters and their gradients, and how slopes are to be retained
- Design levels and the amount of cover over the underpass to the road pavement and shoulders above
- The location of existing and proposed culverts, watertables, drainage channels or water courses, and how roadside drainage will be controlled during and after construction
- Location of legal boundaries, buildings that may be affected, power poles and other road furniture
- Location of any utilities present at the site (for example, power, telephone, water) and any easements within the property that may be affected by the location of the underpass
- Any fencing and/or barriers alongside the road
- Details of the storm water drainage system, including the level and position of subsoil drains and water channels discharging from the underpass
- Details of the FDE capture system for the underpass floor and ramp surfaces, how FDE is contained and subsequently discharged, including relevant details of the pumping system proposed if the grade of the floor and ramps do not allow a gravity flow system
- For higher trafficked roads, details of road safety barrier systems to be adopted
- Reinstatement details of the pavement including how pavement joints are to be constructed to provide a smooth road surface transition.

Particular attention is required around the separate design and management of both the stormwater and FDE. This includes consideration of removal of surface water, mud, and FDE from the lowest point of the underpass. The design of the storm water system should be such that if it overflows it does not enter and overload the FDE system.

Difficult engineering conditions such as a periodic high water table will require specific design, for instance; anti-flotation design, hydrostatic pressure relief, differential displacement provision, groundwater control and additional subsoil drainage.

While proper investigation and design will substantially reduce known risks, it is important to identify these before construction other risks that might arise. These risks need to be identified and discussed between the parties and an appropriate contingency for additional time and cost allowed for.

### 5.2 NZTA BRIDGE MANUAL

RCA's will almost always require the structure to be designed in accordance with NZTA's *Bridge Manual* as underpasses are designed as if they are a bridge structure. The design requirements are summarised in Tables 5.1 and 5.2.

Table 5.1: The Basis of Design, (Adapted from NZTA Bridge Manual)

Design actions	Basis of Design
Design loading	NZTA HN-HO-72, or 0.85HN for lightly trafficked rural bridges (refer Appendix D)
Wind, snow and flood actions	Importance Level category as per AS/NZS 1170
Earthquake actions	Bridge Manual section 5: Earthquake resistant design of structures
Other actions	Statistical distribution appropriate to a 100-year design working life. Where reinforced concrete is used, the cover to steel and maximum crack widths are to be designed to provide this

The greater the Importance Level (as shown in Table 5.2), the higher the designed structural capability required of the underpass. It is important that the underpass supplier is aware of the actual intended location and the Importance Level of the road so that the underpass supplied meets the required design criteria.

Part 4, section 4.1 of this Practice Note touches on the key requirements for reinforced concrete; that is design based on ultimate (ULS) and serviceability (SLS) limit state principles.

Table 5.2: Importance Level and Annual Probabilities of Exceedance for Wind, Snow, Floodwater and Earthquake Actions for Bridges (Adapted from NZTA Bridge Manual), Section 2: General Requirements, Table 2.1

Bridge Usage	Importance Level (as per AS/NZS 1170)	Design Working Life (Years)	Annual Probability of Exceedance for the Ultimate Limit State	Annual Probability of Exceedance for the Serviceability Limit State (SLS)	
				SLS 1 for wind, snow and flood water actions	SLS 2 for floodwater actions
Bridges on no-exit or loop rural roads, not serving a through road function, and serving populations < 50	1	100	1/500	1/25	1/25
Normal bridges, not falling into other levels. Footbridges	2	100	1/1000	1/25	1/50
Bridges on primary lifeline routes categorised on the basis of: <ul style="list-style-type: none"> <li>Volume of traffic carried</li> <li>Route strategic importance (e.g. inter-connection of centres of population)</li> <li>Redundancy of the regional roading network</li> </ul>	3	100	1/2500	1/25	1/100

### 5.2.1 Roadside protection

To reduce the safety risk of vehicles leaving the road and dropping over either end of the underpass, the RCA may require a barrier system to be installed. The NZTA *Bridge Manual*, Appendix B: Bridge Side Protection provides definitive guidance. NZTA's *M23B Specification for Road Safety Hardware Systems* Appendix B: Bridge Barrier Systems also provides details of approved barrier system types as an interim appendix to M23.

Where the underpass extends across the full road width and a flexible system (for example, wire rope safety barrier) or semi-rigid system (for example steel guardrail) is not required, a rigid barrier will still need to be placed along the boundary and extend past the ends of the underpass above road batters to provide roadside protection. These can be made of concrete but often they are constructed of timber depending on the site location and traffic volumes. The design criteria for complying timber rigid traffic barriers are included in section B6 of the *Bridge Manual*.

Positions where guardrail anchor posts are fixed to the top of the underpass need to be designed into the structure, not considered as a retrofit after thought. If a vehicle hits a side barrier this can place a significant sudden horizontal force onto an affixed anchor post and cause the concrete around the anchor hold-down bolts to shear off damaging the structure itself.

Width (bridge end) markers (RM-6) are required if the end post comes within the clear or trafficable approach width of the road. Hazard markers will also need to be installed if there is a reasonable probability of the side barrier being a hazard. NZTA's *Manual of Traffic Signs and Markings* (MoTSAM) Part 2: Markings section 5.02 provides detailed definitive guidance.

Adequate fencing and gates should be constructed to control stock movement when they enter or leave the underpass so they are unable to escape onto the road.

### 5.2.2 Settlement slabs

The *Bridge Manual* specifies that a settlement slab shall be provided at every abutment unless they are agreed with the RCA to not be necessary. Examples where a settlement slab may not be necessary are abutments with no earth filling or low volume or low speed environmental. However, underpasses are generally buried structures and so these will require settlement slabs.

These slabs are simply supported along one edge of the abutment. They should be at least 2 m length and sloped to divert surface water from flowing down into the abutment/soil interface.

## 5.3 UNDERPASS SIZING

To maintain cow flow, the underpass internal width, that is opening size, is best determined by considering a combination of:

- Herd size
- Frequency of use
- Vehicle access requirements for example, motorcycle or tractor
- Access ramp width
- Distance from the dairy shed.

It is essential that cross section area size be sufficiently large to ensure cows will not slow as they enter the underpass because of passage constriction or lack of exit visibility. As the underpass internal width increases so does its capital cost, but this has to be offset against the decreased travel time and the risk of cow lameness over the life of the underpass.

The recommended race width table (Table 5.3) provides some guidance for underpass width depending on herd size. However, because of the cost of underpasses, some reduction from these race widths is appropriate and each farm owner will need to make their own assessment as to what underpass width will be satisfactory for their particular farm operation. Preferably the herd should be managed to allow the cows to walk at their own pace to avoid bottlenecks at the underpass. Irrespective though, significant narrowing of the race on approach to the underpass should be avoided.

*Table 5.3: Race Width Recommendation – From DairyNZ – Efficient Tracks*

Cow Numbers in Mob	Race Width (m)
<120	5.0
120 – 250	5.5
250 – 350	6.0
350 – 450	6.5
>450	Varies depending on the split of the herd

Closer to the dairy shed farm owners usually opt for a wider underpass as it provides better stock flow, especially with larger herd sizes. As a further guide, an underpass supplier should be able to advise the most suitable size for a dairy farm operation based on farm owner feedback from underpasses previously installed.

## 5.4 COW FLOW

Cows have well developed senses and rely heavily on visual stimulation. While they have a wide field of vision, they are poor judges of detail and distance. They also have poor depth perception which explains why they are reluctant to enter dark or shaded underpass areas. Cows have a tendency to move towards light but are sensitive to harsh contrasts of light and dark. Consistency of lighting through a building, such as an underpass, is as important as level of illumination (light intensity).

Cows are less sure footed when walking on downward slopes and prefer to move up gradual ramps rather than steep slopes. A surface that is excessively rough will impair cow flow and contribute to lameness. Slick surfaces will increase the number of slips and falls. Cows may be hesitant to walk on a bare smooth concrete surface inside the underpass. Some spreading of sand or crusher dust may alleviate this, but may create issues downstream in the FDE system due to the presence of these coarse particles. Some solutions for slippery floors are covered in Part 4: Concrete Structures.

The ponding of runoff within an underpass can create cow flow problems as the herd want to slow down because they are unable to see where they are placing their feet. Furthermore, water, mud and stone in an underpass can contribute to lameness.

Designing underpasses that minimise changes in lighting, flooring and slope, as well as providing good drainage will improve cow flow.

## 5.5 RAMPS AND APRONS

Inappropriately designed approach ramps and aprons at the entrance to an underpass can affect cow flow. This can be reduced by ensuring:

- Ramps and aprons are of adequate width for the herd size
- Any narrowing of approaches to the underpass are gradual
- The ramp and apron surfaces are kept clean and are drained to an FDE sump
- A sufficiently long apron that transitions the surface grade from that of the ramp to that of the underpass will improve underpass entrance acceptance by stock and vehicles
- No turns or narrow races on approaches
- As flat as possible approach slope but not steeper than 1:10
- No steep or sudden changes in ramp slope
- The use of post and wire fencing instead of electric fences. Cows naturally bunch when races narrow such as when entering an underpass. If electric fences are used to provide the narrowing, then cows can become scared affecting their travel time and welfare
- Ramps and aprons are constructed with a slip resistant surface. Concrete is preferable over crushed aggregate or “pit” gravel. It is more durable and provides a more impermeable surface on which to collect FDE and stormwater.

To provide structural integrity, the concrete apron is designed to tie the headwall and wingwalls together as an integrated assembly.

## 5.6 HEADWALLS AND WINGWALLS

As part of the design, it is important to consider the potential for scouring of any new batters. Protective retaining structures such as headwalls and wingwalls will assist in preventing or minimising the effects of scouring and damage to side slopes, as well as providing support to the road pavement itself.

Headwalls should be cast onto the end of the culvert, or precast and bolted, and be a minimum of 300 mm in height to sufficiently retain fill over the top of the underpass structure. This is particularly important where the culvert end is close to the edge of the road.



*Box culvert underpass near completion*



The backfill materials behind headwalls and wingwalls need to be assessed to ensure they will provide sufficient stability and bearing capacity under both horizontal and vertical loads. Furthermore, an analysis needs to be undertaken to confirm that settlement and displacement will be within acceptable limits during the design life.

Where a cut surface is to be left above retaining structures, the designer will need to confirm what cut slope angle is appropriate for the *in situ* material and whether a protective covering such as rip rap rock or shotcrete is necessary. Batters should not exceed a maximum slope of 1:1 without professional advice. Wingwalls can be manufactured with either flat or tapered tops.

It is often a safer and a lower cost option, from both a geotechnical and constructability perspective, to extend the length of the underpass rather than having higher retaining wing-walls and steeply cut batters.

The structural designer will need to derive the design loads on the retaining structures, taking into consideration the flexibility and likely deformation. Careful consideration will need to be given to the interaction between the structure, the ground and foundations; under static, dynamic, earthquake and construction conditions.

Earth retaining systems are further explained in section 4.9 of the NZTA *Bridge Manual*.

## 5.7 DRAINAGE

### 5.7.1 Ground water level

The underpass and any sump or pump chamber structures installed must be designed to remain anchored in the event of a high-water table from groundwater, flooding or high rainfall intensity event. Structures such as sumps and some concrete underpass units can be designed with some anti-flotation capability. If there are high water tables, then to achieve the greatest possible internal height, concrete units are preferable over aluminium and galvanised steel culvert pipe options as a reinforced concrete option allows less pavement cover, thereby allowing a higher base level installation. Furthermore, the higher the underpass base level, the shorter the overall structure length required to cross the road. Moreover, less earthworks quantities are required, and flatter access ramp slopes can be designed.

The ideal site is where there is natural fall from one side of the road to the other so that stormwater is able to gravity flow away. However, groundwater running along the base of banks, alongside and at the top of ramps still needs to be cut off (for example by a side wall), captured and channelled away to stormwater, and kept separate to any effluent falling onto ramps. Storm and ground water could flow to an open gully, a grassy swale or constructed wetlands, but there are environmental risks with flowing directly to a water course. Installing subsoil drains (wrapped in filter cloth to avoid clogging) within the drainage fill at the base of the underpass walls can provide effective capture of ground water.

If the chosen site water table height is a real issue, and there are no other crossing place alternatives, then a lower final cost option to consider is negotiating with the RCA to allow reinstatement of the pavement to an increased road height, and taper the elevated surface level back to the existing road level either side of the underpass over an agreed length.

### 5.7.2 Road surface water channels

To avoid stormwater flowing down from the road into the entrance of the underpass, surface water channels alongside the existing road will need to be replaced with a means of allowing continued uninterrupted road drainage in the downslope direction. This could be achieved with a new lined water channel, or by installing a pipe incorporating end headwalls to capture stormwater and have it flow over and beyond the underpass. Similarly, surface water running off from the road surface should be collected in a water channel inside the top edges of the new underpass and channelled away. A concrete headwall along the edge is recommended as it will also assist in avoiding the spilling of pavement aggregate into the underpass entrance.

Any drainpipes installed in the road must have sufficient strength to withstand the combined loads from heavy traffic and compacted backfill. Care must be taken so that pipes and other underground services are not damaged during construction from vibratory compaction and other heavy equipment.

### 5.7.3 Nib walls

A concrete nib wall should be constructed into and across the top of a ramp to direct stormwater away to a drainage channel rather than allowing it to flow down the ramp into the underpass where, if it ponds, it must be captured and treated as FDE. For nib walls over which cows will walk, the recommended dimensions are a square (not rounded) step 50 to 75 mm high and 300 mm wide.

Figure 5.1: Correct (and Incorrect) Nib Wall Design



## 5.8 EFFLUENT MANAGEMENT

### 5.8.1 FDE systems options

Stormwater or groundwater from cut batter slopes that enters or collects in the underpass will mix with sediment and FDE when stock pass through. Irrespective of the volume of stormwater mixed with FDE, it must all be treated as FDE.

If FDE is not contained at, and reticulated from, the underpass it may permeate into the groundwater and the land owner may be subject to a regional council non-compliance action.

A number of FDE capture, transfer, storage and irrigation options are available. Typical options are illustrated conceptually in the Figure 5.2 and described further in the Tables 5.4.

Figure 5.2: Underpasses – FDE System Options

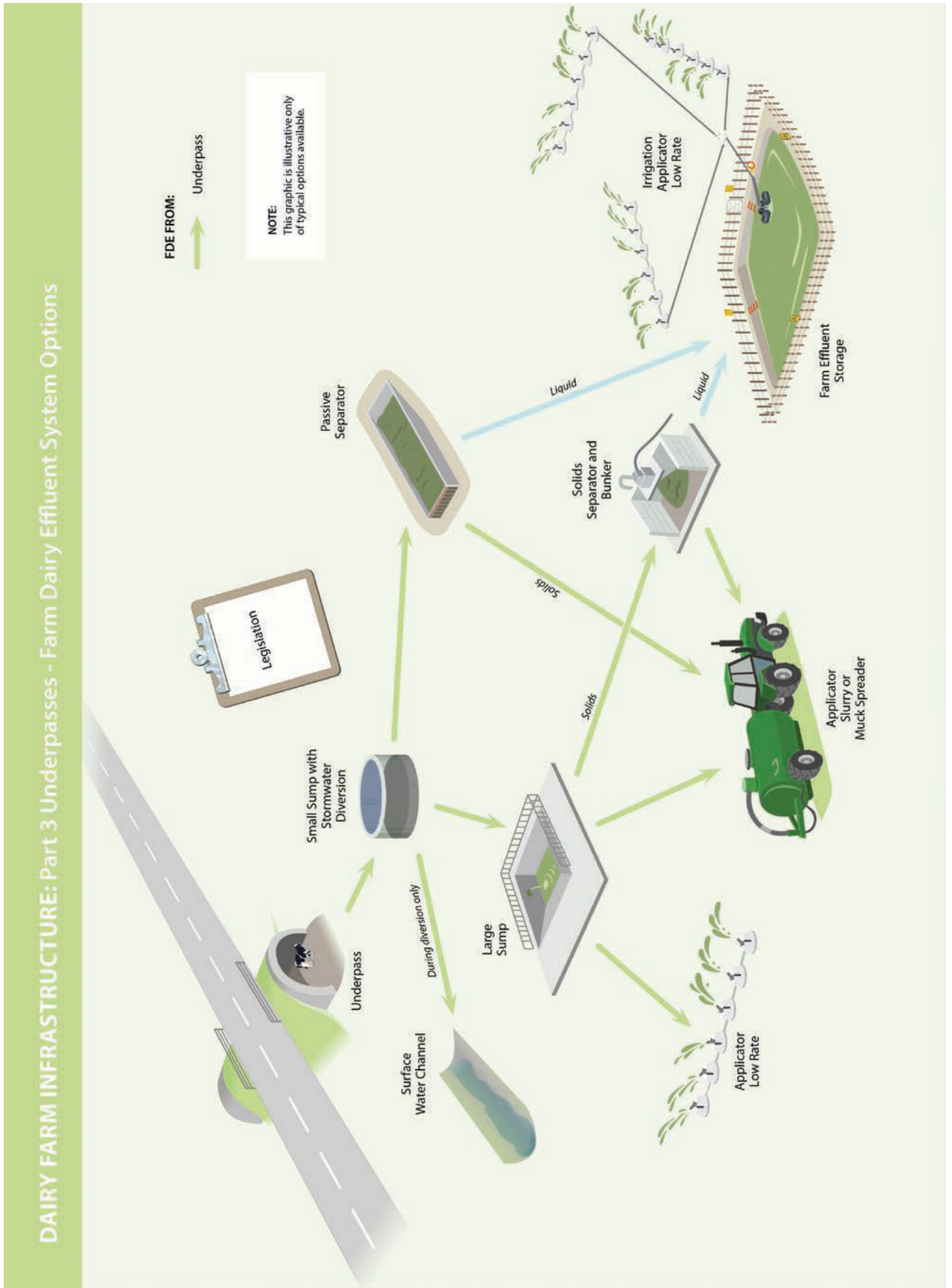
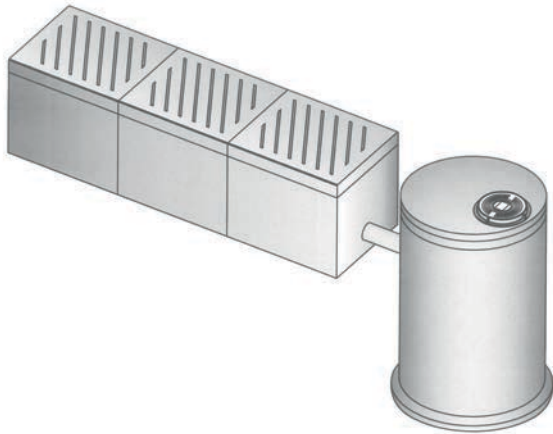

Table 5.4: FDE Capture, Transfer, Storage and Irrigation Options

FDE Capture Options	
<b>Channel to Sump</b>	If space and levels allow, it is advantageous to position a primary sump (or chamber) outside the ramp into which the FDE can gravity flow from the underpass. Solids can also be scraped or hosed along a concrete channel and into this sump.
<b>Interception Grate (For example, Figure 5.3)</b>	Proprietary precast concrete systems are available that can be installed at the lowest level on the underpass approach. Covering the full width of the underpass exit, these capture FDE through a grated cover over a duct. The duct gravity feeds into a sump or chamber from which a submersible sump pump (typically incorporating a stirrer) draws the FDE out when it reaches a pre-set level. The sump can incorporate a stormwater diversion capability which can be manually set.
FDE Transfer Options	
<b>To Stormwater Diversion</b>	All captured FDE should run through a sealed pipe or channel containing a valve, gate or other system which allows stormwater to be reticulated away from the FDE system during the times of the year when the underpass is not being used. Depending on the design, the diversion function may be incorporated into a holding sump.
<b>To (Larger) Sump</b>	If a small sump or chamber is installed a much larger secondary sump in the underpass FDE system is recommended as it can provide a greater temporary storage volume, flow buffering and a suitable location to pump from.
<b>To Stone Trap</b>	A concrete draining pad constructed alongside the stone trap allows the semi-solid muck to spread out while allowing the liquid portion to drain back into the sump. The drier solids can then be more easily removed and spread onto pasture. The stone trap should be installed to operate as described in this Practice Note in Part 2: Solid Separation, section 5.
Storage Options	
<b>To Temporary Storage</b>	Where power reticulation to the underpass FDE storage is not viable, one option is to install a much larger sump or tank at the underpass but use a tractor Power Take-off to pump the FDE back to the main pond or tank using an irrigation mainline. While this type of pump can be used to power a travelling irrigator, they can be costly to run. They are best suited to short-term high volume pumping, not for low rate irrigation systems.
<b>To Main Storage</b>	It is usually preferable for the underpass FDE to flow to the same pond or tank as the FDE generated from around the dairy shed and yards. This option presumes there is sufficient spare capacity to allow for the additional underpass volumes.
Irrigation Options	
<b>Sump to Applicator/Muck Spreader</b>	If the underpass is a very long distance from main storage, one option is to install a separate sump or tank near the underpass but use a slurry tanker to pump out the FDE and irrigate directly to pasture. However, this can be labour intensive and does not provide the same flexibility as a deferred storage system.
<b>Sump to Irrigator</b>	Again, if the underpass is some distance from the main irrigation system it may be more cost effective to irrigate directly from the underpass sump to pasture with a low rate applicator.

Figure 5.3: Example FDE Interception System



### 5.8.2 Stormwater diversion

During times of the year when the underpass is not being used, a stormwater diversion capability should be designed into the system to avoid groundwater and stormwater discharging unnecessarily into the FDE system. Diversion systems usually consist of an inlet pipe where surface water and FDE from the underpass flows into a chamber or sump. There are two pipe outlets from this chamber, one to stormwater and one to the FDE system. The direction of flow out into one pipe, or the other, is usually controlled using a manually operated valve. There are a number of options available including a slide or splitter type valve as illustrated in Figure 5.4.

Figure 5.4: Some Stormwater Diversion Valve Options

Slide Valve	Splitter Valve
 <p data-bbox="204 1877 692 2022">Simple push or pull movement required to open or close the valve. However, the handle needs to be enclosed in a protective chamber to avoid jamming up from surrounding fill</p>	 <p data-bbox="754 1877 1445 1962">Provides discharge to one outlet pipe or the other, but not both at same time. This provides some confidence in avoiding inadvertent FDE discharge to stormwater</p>

In considering which valve option to adopt the following factors should be taken into account:

- The ground and surcharge loadings (for example from farm vehicles) that the valve is required to support
- The maximum fluid operating pressures that the valve is designed for
- Does the valve need supporting, for example with a concrete block underneath?
- Will there be an advantage (or disadvantage) in being able to close off only one outlet at a time?
- How will the valve be cleaned or replaced if it becomes jammed?
- Can the valve be operated easily from the ground surface, or does it require a specifically designed long shafted handle, or other arrangement, to access the valve?
- Can the valve be locked or secured in such a way that it will not be able to ‘creep’ open, and that only authorised staff have access to?
- Is the valve of sufficient quality for the intended use and life of the system as recommended by the manufacturer?

### 5.8.3 FDE storage calculation

As the total volume of FDE captured on the farm will increase because of the underpass, a check needs to be made using the Dairy Effluent Storage Calculator (DESC) to ensure sufficient storage is available in the farms main FDE pond or tank.

The DESC makes allowance for the underpass area. The stormwater catchment area that flows to the underpass sump, typically the ramp areas, is entered in the “Other areas” field under the “Catchments” tab on the online calculator. If the FDE system for the underpass allows stormwater diversion, the catchment area entered into the DESC should be manually reduced in proportion to the part of year the diversion is not in place.

### 5.8.4 Consents

While direct irrigation to adjacent pasture from the sump is possible, there will be some wet days where some regional council rules or consent conditions will not allow irrigation to take place, and underpass FDE will need to be temporarily stored. Furthermore, depending on the local regional council rules, a resource consent may be required if farm owners intend to discharge FDE to specific areas of the farm. Part 1 of this Practice Note which discusses legislation together with *Practice Note 21* Part 1, section 3 describes relevant legislation and regulations in greater detail.

### 5.8.5 FDE systems references

Effluent irrigation is not included in the scope of this Practice Note as there are a number of industry documents which cover this subject area. Recommended are DairyNZ’s – *Farm Dairy Effluent (FDE)* systems publications, some of which are included in the References section of this Practice Note. Of particular relevance are:

- *Planning the right system for your farm*
- *A farmer’s guide to building a new effluent storage pond*

Involving an accredited dairy effluent system designer at the planning stage is recommended to help ensure the most effective design is selected as retrofitting an effluent system to an underpass is often difficult and expensive.

Accredited designers can be found on the Farm Dairy Effluent System Design Accreditation programme website: [www.effluentaccreditation.co.nz/accredited-companies](http://www.effluentaccreditation.co.nz/accredited-companies)

## 6. CONSTRUCTION

### 6.1 INSPECTIONS

Since RCA's are usually taking ownership of the underpass structure and it will become an asset requiring long-term maintenance, they will want to ensure the underpass is sitting on "good ground", has effective drainage and is constructed in accordance with the drawings and specification supplied. They will also want to ensure that any reinstatement of the road following underpass installation will be completed to at least the same condition as before. RCAs may wish to carry out inspections themselves, or rely on the person carrying out the construction monitoring to confirm the designer's requirements have been met through the issuing of producer statement(s).

Inspection items might include:

*Table 6.1: Inspection Items*

Inspection (or Document)	Check
<b>Underpass set out</b>	Orientation, length, depth, ramp slopes, pavement cover
<b>Temporary traffic management</b>	Approved TMP, signage set out, traffic flow, night time provisions
<b>Site</b>	Health and safety plan, underground services location (and relocation), temporary fencing and stock control, Ministry of Business, Innovation and Employment (MBIE) notifications
<b>Earthworks materials</b>	Compaction density and water content control
<b>Underpass trench base</b>	Acceptable foundation condition, allowable bearing pressure achieved, stable cut slopes
<b>Underpass bedding</b>	Suitable bedding material, level, compaction, effective drainage
<b>Concrete unit installation</b>	Alignment, joints, reinforcement, surface finish
<b>Underpass backfilling</b>	Suitable material, compaction, subsoil drainage
<b>Pavement materials and compaction</b>	Complying basecourse (to NZTA M/4) and subbase aggregates, compaction density and water content
<b>Surfacing</b>	Temporary surfacing, seal joints, texture, removal of loose sealing chip
<b>Ramps</b>	Slope, surface finish, width
<b>Effluent management</b>	Sumps, pumps, irrigation, procedures
<b>Road reinstatement</b>	Road markings, signage, drainage
<b>Roadside reinstatement</b>	Permanent fencing, side protection, side safety barrier system, clearing and regrassing

Inspection (or Document)	Check
Inspection (or Document)	Check
Defects Liability	Practical completion certificate, final inspections, defects liability certificate, producer statements, records
Warrantees/guarantees	From underpass supplier and contractor

## 6.2 ROAD CORRIDOR ACCESS

Contractor’s dump sites, equipment storage and other activities should as far as possible be on private land. The work area within the road boundaries needs to be restricted to a minimum so as to limit possible damage to the pavement, underground services and drainage facilities within the road reserve.

Prior to construction contractors must determine the location of underground utilities around the underpass site. Company *beforeUdig* provides a New Zealand wide online service to assist contractors. This service assists in protecting people from underground hazards as well as protecting assets during earthworks.

[www.beforeudig.co.nz](http://www.beforeudig.co.nz)

The New Zealand Utilities Advisory Group have produced a National Code of Practice for Utility Operators Access to Transport Corridors which sets out the processes and procedures for accessing the road corridor.

## 6.3 TRAFFIC MANAGEMENT

Options for temporary traffic management should be discussed with the RCA months ahead of when construction is proposed.

*Table 6.2: Traffic Management Options*

- Bypass the site using adjacent local roads
- Periodic road closures
- Constructing a bypass road at the underpass site.

In determining their preferred option, RCA’s will consider:

- Traffic densities, number and type of vehicles affected by the works
- Service provider requirements
- The capability of the proposed temporary traffic management contractor and demonstration that they have sufficient personnel and equipment
- Speed restrictions and increased travel times
- How often any queued traffic would be let through
- Proposed health and safety around the site
- Whether sufficient notice advertising road closures can be given.

All sites will require a Traffic Management Plan (TMP) meeting NZTA’s Code of Practice for Temporary Traffic Management (COPTTM) prepared by a qualified Site Traffic Management Supervisor (STMS) and approved by the RCA.



## 6.4 CONSTRUCTION ISSUES

### 6.4.1 Affected parties

Service providers, whether they be for power (overhead and underground), telecommunications, gas or water, will have policies around minimising interruption of supply to their customers. Advanced warning of the days and times of supply interruption may need to be communicated to their customers and some coordination will be required between service providers. Local emergency providers such as fire, ambulance and police will require notification as will milk processing and other rural service companies such as Fonterra, transport and mail delivery companies. A local letter box drop is recommended to keep locals informed in advance.

### 6.4.2 Safety

Installing an underpass can be a hazardous activity, not only for the contractor's staff working around the site but also for road users moving through it. There are also real risks around managing the safety of the site at night when no contractor personnel are present. Having a bypass route using other local roads significantly reduces the contractor's safety risks. However, constructing a temporary bypass road that is sufficiently distanced from the worksite may be the only option available. Depending on the traffic volumes, speed environment and subgrade condition, the RCA may require a pavement of greater width, depth and length for the project duration than envisaged and this could add significant cost to the project.

Constructing in one side of the road while vehicles are travelling on the other can be very risky as it requires stable or supported cut slopes below the road surface unaffected by the vibration of both site and passing vehicles.

A crane with a capacity significantly higher than for the load being lifted is usually required. It is unsafe to have the crane jacks founded close to the edge of the underpass trench as there is a risk of destabilising the trench wall during lifting. Therefore, a larger crane with a longer reach is desirable with the advantage that the additional reach will reduce the number of crane setups.

A specific health and safety plan needs to be developed by the contractor for the site. This must identify the hazards and how these will be mitigated. These must include protecting the likes of cyclists and pedestrians, but also stock from entering the work site using temporary fencing and other barrier systems.

### 6.4.3 Backfilling

The backfill material selected needs to be competent free-draining gravel so water does not become trapped behind the underpass walls. Sufficient compaction of this material is equally important otherwise there is a risk of differential pavement settlement over time creating an unacceptably rough road surface above. Careful compaction equipment choice, with advice from the manufacturer if necessary, is needed to determine the maximum vehicle weight and compactive effort that can be applied without damaging the underpass structure, especially for aluminium or galvanised steel units. This risk can be reduced using clean granular hardfill from known sources of competent material.

#### **6.4.4 Groundwater pumping**

Pumping out groundwater from the underpass base while undertaking earthworks and preparing the base can cause various issues:

- Destabilisation of the cut batters, as water is drawn down and out. This movement can increase the amount of backfill needed to replace the material unintentionally removed by pumping
- It is near impossible to adequately compact fine grained soils and sandy materials directly on top of a soft base so as to provide a firm surface on which to place and compact the bedding material for the underpass
- Decreases the stability and hence safety of the batters.

The key to avoiding these issues is to select a site that does not have a high-water table.

#### **6.4.5 Joints**

For precast concrete units, all joints between elements usually need to be waterproofed. Simply tying all the units together (for example by post tensioning) will not provide this waterproofing. As waterproofing can be damaged particularly in the floor by stock, the manufacturer should be notified of the requirement for sealed joints at the time of ordering, as they are best placed to recommend a jointing system for their product.

#### **6.4.6 Road surface sealing**

Cutting off road surface water that can penetrate through the bitumen seal into the overlying pavement will reduce the amount of water that can enter the underpass. A bitumen membrane seal sprayed at a rate of about 2 L per m<sup>2</sup> on the compacted basecourse surface, out to and including the formed water channels, will greatly assist in directing water away from the underpass. Surface water channels across the underpass area need to be sealed, continuous and at a constant grade.

First coat chip sealing of a newly constructed pavement, whether it consists of one or two different chip sizes, will not provide a sufficiently waterproof surface and needs to be followed up with a second coat seal about a year later. As an alternative, many contractors find it more convenient to apply a thin asphaltic concrete (AC) surfacing layer, such as a 35 mm layer of AC14 mix. The main advantages are that a return site visit is unnecessary and the AC is more tolerant of pavement settlement than a chip sealed surface.

# PART 4

## **CONCRETE STRUCTURES**

---

# 1. INTRODUCTION

---

Concrete is a very versatile material that can be moulded into any shape and adapted for a multitude of farm uses. It is a composite construction material formed with aggregates, cement, water and chemical additives. By combining different ingredients in different proportions, and using different construction methods, concrete design and materials can be optimised to meet specific operational requirements on the farm.

While concrete construction for farm infrastructure may appear straightforward, there are many influences which can become quite damaging or corrosive to concrete surfaces on farm structures, such as wear and tear from farm vehicles and animal hooves; and acids in effluent, milk and other substances. Health and environmental effects on people and stock must also be considered in the concrete design.

Concrete is only as good as its design and construction to meet the specific farm application. For many structures the costs of the concrete materials and construction are relatively small proportions of the overall cost. Therefore, cutting corners in materials and construction practice may slightly reduce the total project cost but significantly reduce long term performance. The design and use of concrete in structures is highly regulated and appropriate expertise must be used. It is recommended that a structural designer who is a Chartered Professional Engineer (CPEng) be engaged to advise and provide “fit for purpose” cost effective solutions.

Ready mix concrete suppliers can produce a range of concrete mixes suitable for different applications, and the Cement and Concrete Association of New Zealand (CCANZ) can provide advice on materials and construction practice.

A combination of good design, a selection of appropriate concrete materials and good construction practice, will help to ensure a concrete structure meets both regulatory and operational requirements and is safe, functional and durable.

## 1.1 SCOPE

This part provides general guidance for the design and construction of concrete structures, highlighting the aspects that must be considered to ensure they function as intended in the dairy environment. It is not intended as a design guide for specific structures with specialised requirements, such as milking sheds and dairy housing. It also excludes design for fire and storage of dangerous goods.

This part of *Practice Note 27* is intended for rurally-focussed civil engineering practitioners and contractors with some concrete experience. It is also for technically aware farm owners, and their farm consultants, who are responsible for infrastructure decision making. It is not directed toward those who are already intimately acquainted with concrete infrastructure (for example, structural designers, major concrete suppliers, specialist concrete contractors), although they may find the document a useful reference.

CCANZ's Information Bulletin *Concrete for the Farm (IB 55)* explains in practical terms how to design, mix and place concrete structures on the farm. Because it provides valuable complementary information, *IB 55* is reproduced in full as an appendix to this part and should be read in conjunction with it.

## 2. REGULATIONS FOR CONCRETE STRUCTURES

It is important that all designs use current standards and designers are aware of all updates and amendments to relevant standards

Part 1 section 5.0 of this Practice Note further explores the Building Act 2004 (BA) and includes commentary on compliance with the Building Code.

### 2.1 ENVIRONMENTAL REGULATIONS

Concrete construction must comply with the Resource Management Act 1991 and regional and district council plans and regulations. (Refer Part 1, section 3.0 for further information). These include regulations for disposing of construction waste, such as washwater from cleaning equipment used to mix and place the concrete; and unused concrete. The aim of these regulations is to avoid contaminating waterways and soil, where fish, invertebrates and micro-organisms would be harmed by the high alkalinity of washwater and fresh concrete. *IB 55* section 7.8 gives general information on the disposal of waste from concrete construction.

### 2.2 CONCRETE STANDARDS

The key New Zealand Standards which affect and control the design of reinforced and prestressed concrete are as follows:

*Table 2.1: Key New Zealand Standards for Concrete Construction*

<b>AS/NZS 1170: Structural Design Actions parts 0,1,2,3 and NZS 1170 Part 5</b>
Sets out all the loading requirements for a structure that must be considered in a design, including permanent (or dead) load, imposed (or live) load, snow and ice, wind and earthquake loads.
<b>NZS 3101: Concrete Structures Standard</b>
Gives the key requirements for the design of concrete elements and whole structures to resist the required loadings and to promote durability. This standard in turn references other standards which cover such aspects as specialist design requirements, the production and placement of concrete, and the types and quality of reinforcement which may be used.  Part 1 specifies minimum requirements for the design of reinforced and prestressed concrete structures. Part 2 explains the provisions of Part 1.
<b>NZS 3104: Specification for the Production of Concrete</b>
Prescribes minimum requirements for fresh and hardened concrete and the materials used to make it. Concrete for structures covered by the Building Code must be manufactured in accordance with this standard, which provides requirements for ready mix suppliers as well as mix designs suitable for site mixing.

**NZS 3106: Design of Concrete Structures for the Storage of Liquids**

Provides design information that meets the requirements of the Building Code. It provides a basis for designing liquid-retaining concrete structures that will require only limited periodic maintenance to remain serviceable for their design life, and will not allow loss of the contents in extreme events. It includes containment structures for storing water and wastewater. It does not cover precast concrete pipes, fibre impregnated concrete and bins, or silos for storage of dry bulk materials.

**NZS 3109: Concrete Construction**

Provides minimum requirements for the construction of reinforced, unreinforced, prestressed concrete or combinations of these, in any building elements or structures.

**NZS 4210, NZS 4229, NZS 4230**

**Design and Construction of Concrete Masonry Buildings**

NZS 4210 gives requirements on materials and workmanship for construction of masonry structures.

NZS 4229 prescribes non-specific design requirements for single storey masonry structures up to 600m<sup>2</sup> floor area.

NZS 4230 covers the design of reinforced concrete masonry structures.

Other standards cover the:

- Quality of cement
- Aggregates and water suitable for use in concrete,
- Admixtures which may be used to achieve specific properties
- Reinforcement types
- Welding of reinforcement
- Testing of concrete and concrete constituents.

Australian, British and European standards are used for some applications where suitable New Zealand Standards do not exist.

For farm or rural bridges and underpasses, the NZ Transport Agency *Bridge Manual* sets out the general requirements for loading and design.

## 3. SAFETY

---

### 3.1 SAFETY

The following table is a summary of some hazards presented when working with concrete. Part 1 section 2 explores Health and Safety more fully.

*Table 3.1: Some Concrete Related Hazards*

Hazard	Mitigation
<b>Burns</b>	Cement and fresh concrete can cause severe chemical burns if they come into contact with skin or mucus membranes. Burns can be insidious as injury is not always obvious.
<b>Heavy lifting</b>	Concrete and the materials used to make it are heavy and can easily cause back injuries if lifted or handled incorrectly.
<b>Contamination</b>	Stored materials used to make concrete must be protected not only to prevent contamination and deterioration but also to prevent injury caused by inadvertent contact or access by stock workers visitors to site children or machinery.
<b>Vehicles</b>	The site must be made safe for the equipment that will be used in construction; including deliveries of concrete which may necessitate building temporary access roads.

For the welfare of both people and stock, a designer must consider operational safety needs including those in Table 3.2. *IB 55* also provides some basic guidelines for preventing injury and protecting stored materials.

*Table 3.2: Stock Operations Safety Factors*

<b>Stock Operations Safety Factors</b>
<p><b>Toxicity</b></p> <p>Materials used to build the structure must not cause injury or illness when contact is made with the surface, or contents of the structure (for example, liquids, or bulk stock feed).</p>
<p><b>Hygiene</b></p> <p>In combination with the right materials, surface finish, and treatment of joints, an appropriate cleaning regime must be adopted to ensure structures harbouring organisms that could cause injury or illness to stock or people, meet minimum hygiene requirements.</p>
<p><b>Slip resistant and Durable Surfacing</b></p> <p>Preventing injury through applying appropriate slip resistant and durable surfacing for stock and workers is critical. Floor surfaces must have a slight texture to prevent slipping, but must also be resistant to abrasion and easy to clean. Grooved, scabbled, or stamped textures may be more suitable than raised textures such as a broomed finish, provided that trapped dirt can be removed by normal daily cleaning procedures.</p>
<p><b>Note:</b> While fibre reinforced concrete may improve strength and crack control, it should not be used for surfaces in contact with stock. As the surface wears, fibres protruding from the surface may injure animals.</p>

Safety features in concrete structures such as fire and seismic resistance are achieved via structural design. These features will provide safe egress for occupants and users during and immediately after a fire or earthquake. The structure may be designed to remain fully functional afterwards, to require repair or rehabilitation to restore original functionality, or to require demolition.



## 4. REQUIREMENTS FOR REINFORCED CONCRETE CONSTRUCTION

---

In addition to the safety features described in section 3, a concrete structures designer must consider durability and functionality. This section outlines the key factors to ensuring both these aspects are addressed for any given application.

### 4.1 DURABILITY

The stronger and less permeable the concrete surface and cover concrete are, the more durable the element will be. NZS 3101 includes provisions for durability design to prevent premature damage caused by common levels of exposure to freeze-thaw cycles, abrasion, chemicals and reinforcement corrosion. They involve optimising the following aspects for the anticipated service conditions:

- Concrete compressive strength
- Concrete constituents and mix design
- Depths to which reinforcing is embedded in the concrete.

The designer may need to seek specialist advice for more extreme environments. CCANZ, specialist consultants, and major ready mix concrete suppliers will be able to provide appropriate solutions. *IB 55* section 3 describes the principles of concrete materials and mix design and how they impact on durability.

Concrete's resistance to abrasion, chemical attack, freeze-thaw attack and reinforcement corrosion is strongly influenced by the hardness and permeability of the exposed surface. This is determined not only by the mix design and materials, but also by the methods used to finish and cure the concrete. Irrespective of the quality of the mix design itself, inappropriate curing and finishing techniques will result in a cracked, weak, permeable or delaminating surface. NZS 3101 and NZS 3109 specify methods for finishing and curing, which are also described in CCANZ *IB 55*. Curing is also discussed in section 4.5.

In addition, detailing that physically protects the element from aggressive agents will improve durability. For example, features such as smooth surface finishes, falls, and drip formers will help water and waterborne chemicals to readily drain from the surface rather than ponding and being absorbed into the concrete.

### 4.1.1 Specified intended life

A key question for farm owners should be, “How long do I need this structure to last?”. The Building Code Clause B2 sets out requirements for durability. Its intent is to ensure that a structure will remain functional, safe, and serviceable throughout the period for which it is proposed to be used for its intended purpose.

This period is known as the structure’s “specified intended life”, sometimes referred to as its “design life” or “service life”. As to a definition of what this actually means, there is a harmony across New Zealand legislation, regulation and standards. Examples of definitions of structure ‘life’ are given in Table 4.1.

*Table 4.1: Structure “Life” – Definitions*

<b>Specified Intended Life: Building Act 2004 section 113 (3)</b>
“In relation to a building, means the period of time, as stated in an application for a building consent or in the consent itself, for which the building is proposed to be used for its intended use.”
<b>Design Working Life: AS/NZS 1170:2002 section 1.4.23</b>
“Duration of the period during which a structure or a structural element, when designed, is assumed to perform for its intended purpose with expected maintenance but without major structural repair being necessary.”
<b>Specified Intended Life: NZS 3101: Part 1:2006 section 1.5</b>
“For a building or structure, the period of time for which the building is proposed to be used for its intended use as stated in an application for a building consent.”

The Building Code requires that building elements of a structure must, with only normal maintenance, continue to satisfy the performance requirements of the Building Code for its Specified Intended Life, or less in certain circumstances. Refer to Table 4.2 which has been extracted from Building Code Clause B2 Durability.

Concrete elements in a building usually provide structural support, may be difficult to access or replace, and may be hidden by claddings, linings, services or mechanical plant. Therefore, the default life of at least 50 years usually applies unless the specified intended life is shorter. NZS 3101, the standard for concrete design, is based on providing a 50 or 100-year service life. 100-year life applies to bridges or important structures while 50 years would be the normal default for rural structures subject to building consents.

Dairy farm structures are often designed to shelter or support specific plant items, or service a particular activity; however, such operational functions may be well superseded within 50 years. Therefore, for simple structures such as paths, roads and ancillary buildings, a “life” of less than 50 years will often be appropriate if the structure can easily be repaired, modified or demolished once the owner’s needs change.

*Table 4.2 Clause B2 Durability, extracted from the New Zealand Building Code contained in the First Schedule of the Building Regulations 1992 and amended by the Building Regulations 1997.*

**Performance**

**B2.3.1** *Building elements* must, with only normal maintenance, continue to satisfy the performance requirements of this code for the lesser of the *specified intended life* of the *building*, if stated, or:

- (a) The life of the building, being not less than 50 years, if:
  - (i) Those *building elements* (including floors, walls, and fixings) provide structural stability to the building, or
  - (ii) Those *building elements* are difficult to access or replace, or
  - (iii) Failure of those *building elements* to comply with the Building Code would go undetected during both normal use and maintenance of the *building*.
- (b) 15 years if:
  - (i) Those *building elements* (including the *building* envelope, exposed plumbing in the subfloor space, and in-built chimneys and flues) are moderately difficult to access or replace, or
  - (ii) Failure of those *building elements* to comply with the Building Code would go undetected during normal use of the *building*, but would be easily detected during normal maintenance.
- (c) 5 years if:
  - (i) The *building elements* (including services, linings, renewable protective coatings, and *fixtures*) are easy to access and replace, and
  - (ii) Failure of those *building elements* to comply with the Building Code would be easily detected during normal use of the *building*.

## 4.1.2 Factors affecting durability

The key to achieving durable concrete is identifying potential durability risk factors for the particular site at the design stage, then selecting appropriate means to address them.

The more significant durability factors are presented in Table 4.3 along with suggestions as to how they might be controlled. Further guidance is provided in NZS 3101.

Table 4.3: Factors Affecting Durability

Factors Affecting Durability	Durability Improvement
<p><b>Freezing and Thawing</b></p> <p>Concrete surfaces exposed to continuing cycles of freezing and thawing may delaminate and erode depending on the number of cycles experienced, and the exposure to moisture and abrasion.</p>	<p>Freeze-thaw resistance is improved by the use of appropriate mix design and introducing controlled amounts of microscopic air bubbles into the concrete by adding an air-entraining admixture to the fresh concrete mix.</p>
<p><b>Chemical Attack</b></p> <p>Concrete is an alkaline material, therefore inherently resistant to most alkaline and neutral pH substances. However, it is not resistant to acids or sulphates. Consequently, concrete surfaces in contact with acidic materials such as lactic acid (in milk), silage, manure, fertiliser, contaminated soil, some cleaning fluids, or even just soft ground-water can breakdown and erode quickly, particularly if also exposed to abrasion or flowing water. Sulphates can cause the concrete to expand and heave before disintegrating.</p>	<p>Chemical resistance to mild exposure can be improved by appropriate concrete mix design and materials. Concrete exposed to highly aggressive chemicals such as hydrochloric, nitric or sulphuric acids must be protected by barrier coatings or linings resistant to the specific chemicals of interest. Such coatings usually need to be applied by specialist applicators, and will need regular maintenance to remain effective.</p>
<p><b>Abrasion Resistance</b></p> <p>Abrasion resistance is an issue where the concrete is exposed to traffic by steel wheels, hard plastic wheels or hooved animals; or to scraping, scoring and impact by machinery such as front end loader buckets. Abrasion is exacerbated when the surface is also exposed to chemical attack, freezing and thawing, and/or running water such as when cleaning concrete surfaces by hosing or water blasting.</p>	<p>Abrasion resistance is improved by using higher strength concrete than is needed for structural purposes alone, and by careful attention to finishing and curing practices.</p>

Factors Affecting Durability	Durability Improvement
<p><b>Corrosion of Reinforcement</b></p> <p>Reinforced and prestressed concrete are composite materials, relying on both the concrete and the reinforcement to provide the desired structural performance (see section 5). Therefore, the durability of the reinforcement also must be considered. The most common and widespread concrete durability problem in New Zealand is corrosion of steel reinforcement. Steel embedded to sufficient depth in alkaline concrete does not normally corrode, but it will corrode if the concrete surface exposed to moisture and is porous, damaged, or exposed to seawater, sea spray or some specific chemicals, including certain fertilisers. Reinforcement corrosion often causes cracking and spalling of the overlying concrete. Cracks trap dirt, and allow aggressive substances into the concrete matrix thus accelerating corrosion and other deterioration mechanisms. Irrespective of whether the steel corrosion damages the concrete, eventually it will significantly reduce the effective cross section area of reinforcement in the structure, which can affect its load bearing capacity. Minimising the risk of reinforcement corrosion is therefore a fundamental part of the design of concrete elements and structures.</p>	<p>Corrosion of steel reinforcement is managed by optimising the concrete compressive strength, type of cementitious binder, and cover depth to reinforcement to reduce the ability of water and chloride ions to migrate through the cover concrete to the steel surface. More corrosion resistant reinforcing materials may also be used.</p>
<p><b>Crack Control</b></p> <p>Although reinforced concrete is designed to crack, cracks and inadequately detailed joints can allow the ingress of water and waterborne substances, and thereby aggravate the durability problems described above. They also harbour dirt and micro-organisms, which can cause hygiene problems.</p>	<p>Crack control and joint design risks can be managed by attention to at the design stage, construction techniques, and good maintenance practice.</p>
<p><b>Surface Finishing and Curing</b></p> <p>Concrete's resistance to abrasion, chemical, freeze-thaw attack, and reinforcement corrosion is strongly influenced by the quality of the concrete and particularly the exposed surface. The quality of the surface is determined not only by the mix design and materials, but also by the methods used to finish and cure the concrete. Inappropriate curing and finishing techniques can result in a permeable, cracked, weak or delaminated surface irrespective of the quality of the concrete mix itself. The outer layer (or 'cover') concrete protects the steel reinforcement from corrosion; therefore, its ability to prevent the ingress of moisture and other harmful elements is crucial to the life of the structure.</p>	<p>Some types of concrete are more susceptible than others to shortcomings in finishing and curing. For example, in warm or windy conditions concrete designed for chemical resistance may crack while it's setting. The concrete supplier will be able to give advice on appropriate methods for finishing and curing the concrete supplied for a particular application, particularly if durability of the surface is important.</p>

## 4.2 FUNCTIONALITY

Functional or “serviceability” requirements include the strength, stability, ductility and stiffness of structures and their individual members. Meeting these requirements is part of the structural design process outlined in section 5.1.

### 4.2.1 Cracking

Cracking is a major aspect of serviceability that’s considered as part of the structural design. Reinforced concrete is designed to crack in predetermined locations under tensile and flexural stress. To minimise durability and hygiene problems, maintain water tightness of liquid retaining structures, and to avoid unacceptable visual effects, the designer specifies the amount and position of reinforcement and joints to control crack widths and locations.

Concrete may also crack unexpectedly as a result of physical overload, inadequate design or construction practice, or poor resistance to environmental conditions during construction or in service. For more information see *CCANZ IB 73: Cracking*.

## 4.3 COMPRESSIVE STRENGTH

The minimum compressive strength required is determined by structural requirements. Typical compressive strengths required for general purpose concrete construction range from 20 to 50 MPa. The designer will determine the minimum compressive strength required for a particular structure.

To provide adequate abrasion resistance on slabs exposed to abrasive actions, a higher strength may be needed than for structural purposes alone. Table 4.4 provides guidance for minimum strength requirements for abrasion resistance in different environments.

*Table 4.4: Selection Guide for Concrete Slab Floors (adapted from NZS 3101: Part 1: 2006, Table 3.8 – Requirements for Abrasion Resistance for a Specified Intended Life of 50 Years.)*

Service Conditions	Application	Finishing Process	Curing	Min. Specified Compressive Strength at 28 days (MPa) (f' )
<b>High Abrasion</b>	Cow standing areas subject to feed out and scraping vehicle movements, (for example feed pads)	Power floating and at least two passes with a power trowel before applying a	7 days’ water curing using ponding or covering; or the use of curing	40 MPa
<b>Moderate Abrasion</b>	Cow standing areas with light vehicular traffic only, (for example dairy yards)	slip resistant surface texture	membrane that meets NZS 3109	30 MPa
<p><b>Note:</b></p> <ul style="list-style-type: none"> <li>• 30MPa with supplementary cementitious material (SCM) (or type GB cement instead of type GP plus SCM) is generally considered acceptable for durability in chemically-aggressive farm environments, particularly for design life 50 years or less.</li> <li>• If the SCM is slag (or slag cement) rather than microsilica it would be more appropriate to specify 30MPa at 56 days.</li> <li>• Microsilica is usually added at about 8% replacement of the type GP cement.</li> <li>• Concrete containing SCM needs wet curing, and is susceptible to plastic shrinkage cracking before setting unless precautions are taken.</li> </ul>				

The mix designs needed to provide other durability requirements (for example resistance to acids and other chemicals, or ingress of chloride ions) are also often stronger than needed for structural purposes. For example, a 50 MPa concrete may be provided for a slab exposed to acidic conditions even though only 30 MPa may be needed for structural purposes. The concrete supplier will determine the strength of concrete to supply to meet both structural and durability requirements.

**Note:** The mix design guidelines in *IB 55* section 3.3.2 categorise concrete in terms of five applications referred to as Mixes A to E. The indicative strengths quoted in parentheses for each of these categories are minimum strengths for structural purposes, and do not account for durability requirements.

## 4.4 SPECIFYING CONCRETE

Larger volumes and structural concrete are best supplied by a ready mix concrete plant in accordance with NZS 3104. The ready-mix supplier will be responsible for the mix design and ensuring every batch of concrete delivered is of satisfactory quality. It is **never** appropriate for a designer or purchaser to specify mix design parameters such as water to cement ratio or aggregate grading for ready mixed concrete stronger than 25 MPa. Therefore, this Practice Note does not provide information on mix design other than the general principles and the guidance for site mixed concrete presented as in *IB 55*.

The designer or purchaser may, however, specify one of the NZS 3104 Prescribed Concrete mix designs for concrete of compressive strength from 10 to 25 MPa. Prescribed Concrete can be supplied as ready mix or mixed on site.

*Table 4.5: Terms Used When Specifying Concrete*

### Terms Used When Specifying Concrete

“**Normal Concrete**” is specified by workability (“slump”) and compressive strength. Normal Concrete is suitable for most structures subject to specific design. It covers compressive strengths from 17.5 to 50 MPa.

“**Special Concrete**” is specified by workability, compressive strength and any other property required. It is used where properties such as; reinforcement corrosion resistance, chemical resistance, freeze-thaw resistance (and sometimes abrasion resistance) are important, or where particular types of concrete are used (see section 5.2). If supplementary cementitious material (SCM) such as microsilica is added, then the concrete is specified as Special Concrete.

The **specified compressive strength** ( $f'_c$ ) is the minimum strength required to meet structural needs. To provide the required durability, the compressive strength supplied may be higher. For properties, other than strength and slump, the means of assessing compliance also need to be specified. Some ready mix concrete plants may be unable to produce Special Concrete to meet the specific project requirements.

**Note:** *IB 55* differentiates between structures covered by the Building Act and those that aren’t. Although the consequences of inadequate concrete performance may be less severe in a structure not covered by the Building Act, this Practice Note takes a conservative approach by assuming all concrete structures are covered by the Act.

Because of the risks and time involved, most farm owners will find it more convenient to engage a concrete placing contractor, or order ready mixed concrete, rather than trying to mix their own. However, if the concrete must be mixed on site, the concrete ingredients and mix designs recommended in *IB 55* should be followed. These are based on NZS 3104 Prescribed Mix requirements, and provide for minimum strength requirement only, not for durability.

### 4.4.1 NZRMCA Certificate of Audit

The New Zealand Ready Mixed Concrete Association (NZRMCA) operates an independent audit scheme that issues a Certificate of Audit to ready mix plants. The scheme covers most concrete plants in New Zealand. A list of plants holding current NZRMCA Certificates of Audit NZRMCA can be found at:

[www.rmcpplantaudit.org.nz/rmca/rmca-audited\\_plants.htm](http://www.rmcpplantaudit.org.nz/rmca/rmca-audited_plants.htm)

For the supply of structural concrete with compliance to *NZS 3109 Concrete Construction* and *NZS 3104 Concrete Production* and hence the NZ Building Code, a plant with a current Certificate of Audit for the specific strength and type of concrete required should be selected for concrete supply. A plant Certificate of Audit is valid for up to 12 months and provides purchaser assurance that the specified concrete delivered to site has been produced in accordance with NZ standards. Note that some ready-mix suppliers, including some NZRMCA members, are uncertificated and will be unable to demonstrate this compliance.

## 4.5 CURING

*IB 55* describes placing, finishing and curing methods.

Concrete hardens not by drying but by a chemical reaction between the Portland cement and water. This reaction is called 'hydration'.

As concrete dries, it shrinks. Shrinkage generates tensile stresses within the concrete. If the shrinkage stress exceeds the tensile strength of the concrete, then the concrete will crack. Concrete slabs have a large surface area to volume ratio therefore are particularly sensitive to inadequate curing.

In warm or windy weather\*, concrete needs to be protected from drying during the finishing process otherwise it may crack while it is setting. This is achieved by applying a fog spray or by coating the surface with an anti-evaporation aid.

\*A rule of thumb is if it is good weather for drying your washing on the clothesline then the concrete will be susceptible to cracking before it sets.

Some types of concrete are more susceptible than others to shortcomings in finishing and curing. For example, in warm or windy conditions high strength concrete or concrete designed for chemical resistance may crack while it's setting. As well as advising on the appropriate mix design after considering site conditions and the application, major concrete suppliers should also be able to provide advice on appropriate methods for finishing, early age care and curing concrete supplied for a specific application, particularly if surface durability is important.

Proper 'Curing' is about maintaining satisfactory moisture content and temperature immediately following concrete placing and finishing to optimise the hydration of the cement.

### 4.5.1 Moisture control

Curing to retain moisture after the final surface finish is applied, or the formwork removed, involves either:

- Applying water continuously to keep the entire concrete surface wet (wet curing), and
- Tightly covering the exposed surface and edges with an impermeable sheet material to prevent evaporation of the mix water (covering); or
- By applying a chemical curing compound to prevent evaporation.

High strength concrete or concrete for particularly aggressive conditions (that is most Special Concrete) must be wet cured.



## 4.5.2 Temperature control

In hot or cold weather, extra precautions may be needed to minimise the temperature difference between the internal concrete, the surface concrete, and air immediately above the concrete surface temperature. Temperature differences exceeding about 15 degrees C may cause uncontrolled surface cracking. Cool temperatures reduce the rate of hydration and hence strength development.

*Table 4.5: Effect of Curing Temperature on Rate of Hydration*

Effect of Curing Temperature on Concrete Strength	
< 10 degrees	Unfavourable for the development of early strength
< 4 degrees	Development of early strength is greatly retarded
< 0 degrees	Little or no strength develops.

## 4.5.3 Strength development

Concrete strength gain is initially rapid but then slows over time. It will continue almost indefinitely provided the concrete retains sufficient water for the cement to hydrate. Further, the rate of strength development depends on the curing temperature, as shown in the following figure.

*(Note: data is typical only and assumes continuous wet curing for 28 days)*

*Figure 4.1: Effect of Temperature on Rate of Compressive Strength Development.*

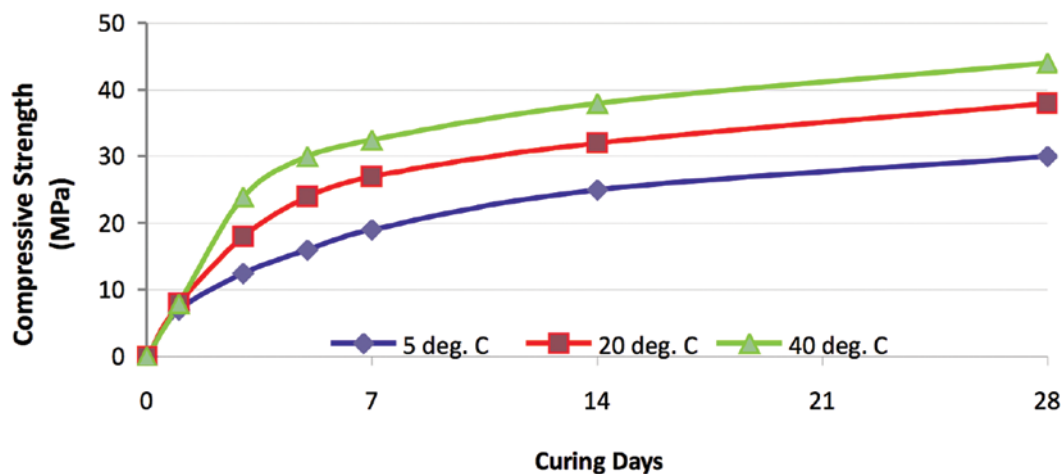

Proper curing through moisture and temperature control is essential to ensure the required durability and strength is achieved, and is particularly important for surface durability.

# 5. REINFORCED CONCRETE DESIGN

## 5.1 REINFORCED CONCRETE

### 5.1.1 Theory

Concrete is very strong in compression but relatively weak in tension. Typically, steel bars of various sizes are used as reinforcement to improve tensile performance in concrete. Other materials can also be used, such as fibres made from steel, glass or plastic. Concrete has reasonable strength in shear and shear resistance can be further increased by reinforcement. Under load (as illustrated), the concrete on the tension side of a member will crack. In reinforced concrete, the cracks allow the reinforcement to stretch and take up its part of the load.

Figure 5.1: Crack Pattern in Concrete under Load, Without and With Reinforcement

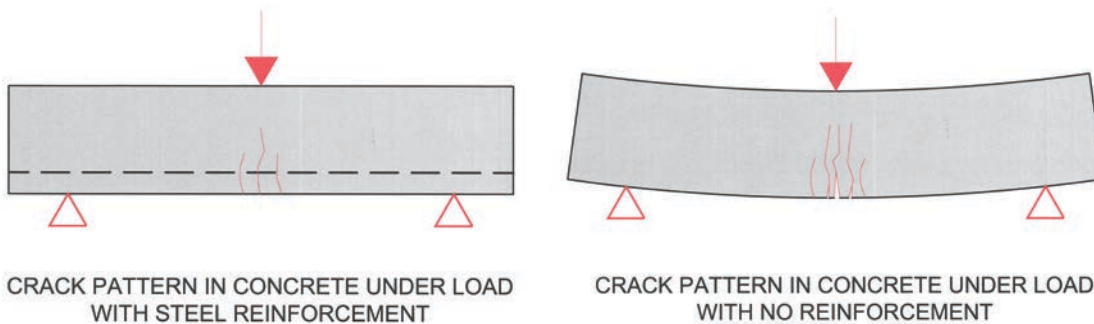

### 5.1.2 Structural design

Reinforced concrete structures are generally developed based on what is known as their limit states (as defined in Table 5.1) and some key design requirements (see Table 5.2).

Table 5.1: Concrete Design Terms

Limit States
<p><b>Serviceability Limit State (SLS)</b></p> <p>The state at which a structure becomes unfit for its intended use through deformation, vibratory response, degradation or other operational inadequacy.</p>
<p><b>Ultimate Limit State (ULS)</b></p> <p>The state at which the strength or ductility capacity of the structure is exceeded, or when it cannot maintain equilibrium and becomes unstable.</p>
<p>The structural designer develops a particular design by meeting these limit state requirements while taking into account:</p> <ul style="list-style-type: none"> <li>• Site conditions</li> <li>• Design working life</li> <li>• Intended use of the structure</li> <li>• Design codes that need to be complied with</li> </ul>

Table 5.2: Key Design Requirements for Reinforced Concrete

Key Design Requirements for Reinforced Concrete
<p><b>Ultimate Strength</b></p> <p>The reinforced concrete must develop the required ultimate strength in bending, compression, tension, shear and torsion to resist a given set of load conditions to suit the structure's requirements. The stresses developed within the structure under load must be within the safe permissible limits.</p>
<p><b>Serviceability</b></p> <p>The structure must satisfy the serviceability requirements to limit any deflections to within agreed or specified limits, and to limit cracking. It must also be designed to ensure it can resist environmental loads and maintain its serviceability throughout its expected lifetime – that is it is durable.</p>
<p><b>Safety</b></p> <p>The structure must have adequate safety from overturning or sliding, buckling and vibration, and able to resist any vertical or lateral loading imposed on it by the environment such as snow, wind and earthquake, soil and water pressure. Components which provide safety to users may also have to be designed into the structure (for example, protection from falling).</p>

### 5.1.3 Reinforcement design

In determining the required type, size and location of reinforcement in a concrete element the following two essential calculation steps are required:

- **Firstly**, the element's **Ultimate** strength is considered, that is the strength at which the reinforcement will just begin to yield, and
- **Secondly**, the **Service** conditions are considered. This is to check that in normal loading conditions it will have satisfactory resistance to deflection, cracking and vibration.

These steps, as explained in AS/NZS 1170, are summarised in Table 5.3.

Table 5.3: The Reinforced Concrete Design Process

Reinforced Concrete Design Process Steps	
<b>Preliminary</b>	<ul style="list-style-type: none"> <li>• The self-weight and permanent loads of the member are calculated</li> <li>• The imposed (or live loads) appropriate to the structure, its use, importance, and expected life are sourced from NZS 1170.0–5, as well as any manufacturers' requirements for machinery or other items supported by the member. This also includes wind, snow and ice and earthquake loads as appropriate</li> <li>• These loads are combined in several loading combinations as set out in AS/NZS 1170.0 to create a series of Ultimate and Service loads</li> <li>• The stresses (bending moments, shear, torsion, tension, and compression produced by the various combinations of these forces) are calculated.</li> </ul>
<b>Firstly</b>	<ul style="list-style-type: none"> <li>• The <b>Ultimate</b> strength capacities of the proposed section in relation to these forces are calculated and then factored by the relevant strength reduction factor in accordance with NZS 3101</li> <li>• The imposed actions and the capacities are compared and, provided that the factored capacity is greater than the imposed actions, the section is satisfactory.</li> </ul>
<b>Secondly</b>	<ul style="list-style-type: none"> <li>• A second set of load combinations is then considered for the <b>service conditions</b> or <b>serviceability cases</b>. These will be reviewed to ensure that the member and total structure do not deflect too much under normal loading, that crack widths are within reasonable limits, and that any likely vibrations within the structure or the structural elements are acceptable and comfortable to people and stock.</li> </ul>

## 5.2 TYPES OF CONCRETE

In addition to the traditional concretes used for most types of construction, specialist ready mixed concretes have been developed to improve ease of placement, crack resistance, rapid commissioning, and other properties. Examples of these are included in Table 5.4.

*Table 5.4: Some Different Types of Concrete*

Some Different Types of Concrete
<p><b>Pneumatically Sprayed Concrete</b> such as “shotcrete” or “gunite”, which may be suitable for constructing retaining walls.</p>
<p><b>Self-compacting Concrete</b> may be suitable for heavily reinforced structures or where a high quality finished surface is needed for durability or hygiene (CCANZ <i>IB 86</i>).</p>
<p><b>Shrinkage Compensating Concrete</b>, which if appropriately restrained and reinforced, can prevent shrinkage cracks opening up between contiguous pours, for example, large floor area pours.</p>
<p><b>Fibre Reinforced Concrete.</b> Fibres can be used in place of all or some of the steel reinforcing to reduce the risk of the concrete cracking while it is setting, or to improve abrasion and impact resistance. Fibre reinforcement avoids the problems associated with corrosion of conventional steel reinforcing bars and therefore may be beneficial in aggressive environments on the farm (CCANZ <i>IB 39</i>).</p>
<p><b>Note:</b> Fibres will protrude from the concrete surface once it starts to wear, so some types of fibres such as steel may not be suitable for concrete surfaces in direct contact with stock.</p>
<p><b>Concrete with Improved Resistance</b> to mild exposure from acids and sulphates is useful for structures such as milking platforms and silage storage.</p>
<p><b>High Early Strength Concrete</b> can receive traffic within a short time of placement, which may help to minimise disruption to daily operations when modifying existing floors, or in cooler weather.</p>

## 5.3 PRESTRESSED CONCRETE

Prestressing works on the general principle that steel or tendons can be stretched and anchored so to apply a compressive preload on the concrete member. The principle is that if the concrete is kept completely in compression by the prestressing, it is capable of resisting a higher loading than with reinforcement alone. It is also used to reduce or eliminate cracks. Prestressed concrete offers many benefits, as shown in Table 5.5.

*Table 5.5: Advantages of Prestressing*

Advantages of Prestressing
<ul style="list-style-type: none"> <li>• It can be developed for a variety of applications, for example, beams and lintels, panels for bunkers, tanks and retaining structures</li> <li>• Required loading capacity can be achieved with a reduced concrete depth. Prestressed members have a higher span-to-depth ratio than conventionally reinforced members</li> <li>• The extra load resistance and reduction in cracking makes it particularly useful for large floor areas, especially on poor ground</li> <li>• The reduction in cracking improves durability</li> <li>• The reduction in cracking that might otherwise reduce water tightness makes prestressed concrete very useful for liquid retaining structures.</li> </ul>

As illustrated diagrammatically, stressing may be carried out either as:

- **Pre-tensioning:** tendons are tensioned to the required force prior to the concrete being poured; or
- **Post tensioning:** tendons are pulled through ducts in the concrete and tensioned after the concrete has hardened. Ducts may be filled with grout after the tendons have been tensioned.

Figure 5.2: Post Tensioning

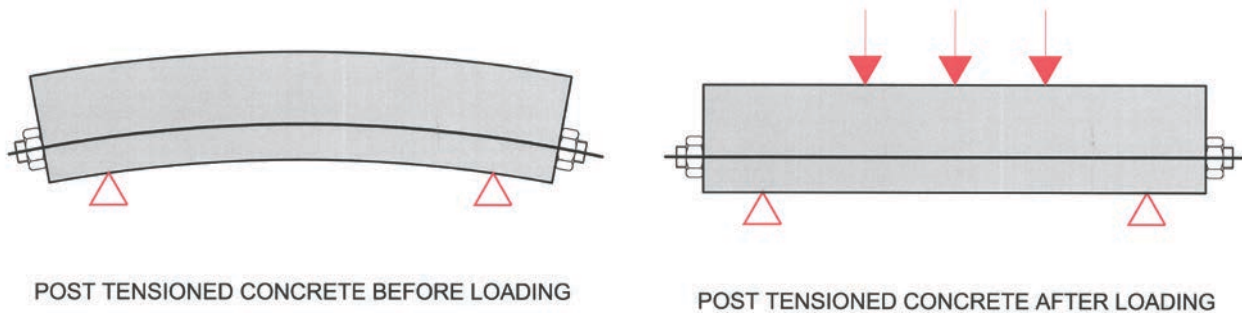

## 5.4 PROPRIETARY PRODUCTS

Precast concrete products are manufactured by processes that can achieve more efficient consolidation and curing than in cast *in situ* concrete. Precast concrete may therefore be less permeable and consequently more durable.

Many precast concrete products are available for use on farms, including general purpose elements such as beams, pipes, water tanks, septic tanks, culverts, underpasses and utility poles. Also available are special purpose units such as troughs for water and feed, stone traps, dry storage bunkers, slatted floor units, stock control grids, loading races, well liners, site-assembled effluent holding tanks.

All precast units that form part of a building subject to Building Code requirements must comply with relevant standards.

Coatings, linings and other materials marketed for protecting concrete surfaces must be specifically designed for the application being considered, and applied strictly in accordance with the manufacturer's recommendations.



Reinforced concrete storage bunker with draining pad, stone-trap and sump

## 6. MASONRY CONSTRUCTION

---

### 6.1 MASONRY CONSTRUCTION

Structures constructed from concrete masonry blocks are common on farms and include structures such as bunkers, ancillary buildings, sumps and stone traps. Furthermore, masonry walls are often built to physically support other structures such as platforms, ladders and equipment.

Most masonry forms of construction will require a building consent. In particular, it will be necessary to demonstrate that they can comply with Building Code Clause B1 (Structure) and B2 (Durability) as well as other parts of the code which may be applicable depending upon the use.

It is recommended that for all but the simplest structures, a specialist be engaged to assist with the design and specification of the blocks, reinforcement, mortar and concrete infill for masonry design. Structures up to one storey designed to NZS 4229 are required to have a designer who on the basis of experience or qualifications is competent to design structural elements. Most farm masonry structures will come under NZS 4229. A CPEng is necessary for specific design to NZS 4230.

Materials and methods for masonry construction are specified by NZS 4210.

### 6.2 UNREINFORCED MASONRY

Concrete masonry blocks may be solid or hollow. Hollow blocks used in unreinforced masonry walls are usually left unfilled. Unfilled hollow block walls can often be used for small independent structures, such as walls and low retaining walls up to about 600 mm high.

Some buildings may be able to be constructed with unreinforced masonry, but they are very vulnerable to wind and seismic loadings and therefore have to be specifically designed to ensure that they are strong enough to meet Building Code requirements to resist these loads. Inserting reinforced concrete bond beams in the design will assist with the strength and stability, but their use and extent and the reinforcement that goes into them, needs to be professionally designed.

Unreinforced masonry can be supported by building piers into the masonry, or by some kind of secondary framing such as timber, concrete or steel, (although this may well begin to make the structure uneconomic). Commonly, the main frame of the building is in another material so that the masonry tied to it just becomes a veneer to provide a finish and weatherproofing.

Unreinforced brick or block veneers must always be tied back to the main structure of the building to ensure that they have support and will stay in position during a seismic event. This may entail leaving movement gaps at discrete locations, or making the ties strong enough and accepting that in some cases localised cracking of the veneer will occur.

### 6.3 REINFORCED MASONRY

Reinforced concrete masonry walls can provide strength and versatility. The hollow units are generally built up from a reinforced concrete footing with steel starter bars extending upwards from the foundation. The blocks are placed over the starter bars and mortared into place. As the wall rises, more reinforcing bars are introduced to lap onto the starter bars. The hollows are filled with a grout or special concrete mix which is compacted around the reinforcement.

Most hollow block units contain partial height webs so that horizontal reinforcement can be placed into the wall, wired to the vertical reinforcement, and cast with the concrete infill. This creates a complete grid of reinforcement within the wall and makes for robust construction. The system can be used to build foundations for larger buildings, create buildings of more than one storey and retaining walls several metres in height. However, they can be unsuitable for the containment of liquid storage in an acid environment, or FDE because they are not sufficiently impermeable without a suitable geomembrane or durable waterproof and (if necessary) chemically resistant lining.

Some reinforced masonry walls will require either piers to provide extra support, or some form of structural framing. Whenever reinforced or unreinforced masonry is built up against a building frame, it is normal to tie the masonry to the frame. This helps to provide support for the masonry and in some cases bracing for the frame.

NZS 4229 describes a number of reinforced concrete masonry types (standard designs) that do not require specific design. However, if a particular structure is outside of these categories, then a specific design is required and must comply with NZS 4230. It is the task of the design professional to establish, given specific criteria, whether a specific design is required or not. The advantage of showing that the requirements meet a standard design is that professional design time is significantly reduced and approval is usually more straightforward.

Input from a CPEng will be required to review suitability of standard design and to complete all specific, that is, non-standard designs to NZS 4230.

## 6.4 MASONRY WALL VERSUS PRECAST CONCRETE PANEL

For farm applications, both precast concrete panels and masonry wall construction can offer advantages, but a decision will need to be made as to which approach to choose.

Differences between using masonry construction and precast concrete panels are summarised in the following table.

*Table 6.1: Masonry versus Precast Concrete: Advantages and Disadvantages*

	Masonry Wall Construction	Precast Concrete Panels
<b>Advantages</b>	<ul style="list-style-type: none"> <li>• Smaller scale masonry construction is generally cheaper than using precast concrete</li> <li>• Generally, small projects can be undertaken on a ‘do-it-yourself’ basis or with the assistance of a small building company</li> <li>• Can be built in small sections so that the work can be progressed as and when required</li> <li>• Does not require heavy lifting equipment</li> <li>• Some work will not require building consent</li> <li>• Most work can be produced from the non-specific designs of NZS 4229 (but will still require building consent)</li> <li>• Masonry can be used to provide the edges for ground slabs and provide a foundation base for a building or structure above</li> <li>• Foundations for masonry can be simple and often can be built up from a reinforced concrete ground slab.</li> </ul>	<ul style="list-style-type: none"> <li>• Precast panels can be produced off site and brought to site for erection onto prepared foundation reducing the actual construction time</li> <li>• Precast panels are very good for forming tanks, storage bins and retaining structures with waterproof joints, but the size of the project would need to warrant its use</li> <li>• Precast tilt up slabs can be used to form large buildings and may be used as part of the structural framing</li> <li>• Precast panels can be used as cladding units by bolting onto a frame – this helps to reduce construction times</li> <li>• Generally, precast units can be designed to resist seismic forces without imposing restrictions on the size of structure which can be developed.</li> </ul>
<b>Disadvantages</b>	<ul style="list-style-type: none"> <li>• There are limitations on the sizes and types of blocks available and this does therefore create limits on the size of structure which can be developed</li> <li>• Seismic design consideration may limit the size of blockwork panels which can be used</li> <li>• To build blockwork above about 1.5 m in height, a scaffolding platform will be required</li> <li>• Not suitable for the containment or storage of liquids such as FDE (without geomembrane lining).</li> </ul>	<ul style="list-style-type: none"> <li>• In general, precast concrete panels will require a specific design reviewed by a CPEng.</li> <li>• Precast concrete tends to be more expensive than masonry especially for smaller projects</li> <li>• Generally, requires heavy lifting equipment to position precast units</li> <li>• Foundations for precast units tend to be heavier although they can be incorporated with a properly designed reinforced concrete ground slab.</li> </ul>



## 7. CONCRETE STRUCTURES FOR THE FARM

When a structure of any kind is required, it is not uncommon to think in terms of quick and easy construction with whatever materials and labour are available. Often these types of *ad hoc* structures, particularly walls for bunkers, effluent sumps, retaining walls and even nib walls, are not fit for their purpose and as a result can deteriorate rapidly requiring continuing repair. Incorporating appropriate design standards at the beginning of a building process will reduce risk and be cheaper in the long term.

### 7.1 RETAINING WALLS

Retaining and bunker walls not properly designed and constructed have the potential to become dangerous in use. Accidents do happen where retaining walls overturn because of inadequate foundations or wall design. Apart from the risk to personnel working under or near the walls, there is always the added cost of dealing with failed structures, clearing debris, possible loss of materials and reconstruction.

For significant walled storage areas where mechanical plant will be used to stack and dig solids against walls, reinforced concrete specifically designed for the purpose is recommended. Standard precast concrete units are available which can be incorporated together to produce this type of structure, subject to cost and transport, and may be beneficial in terms of construction time and ease.

Figure 7.1: Retaining Wall Options

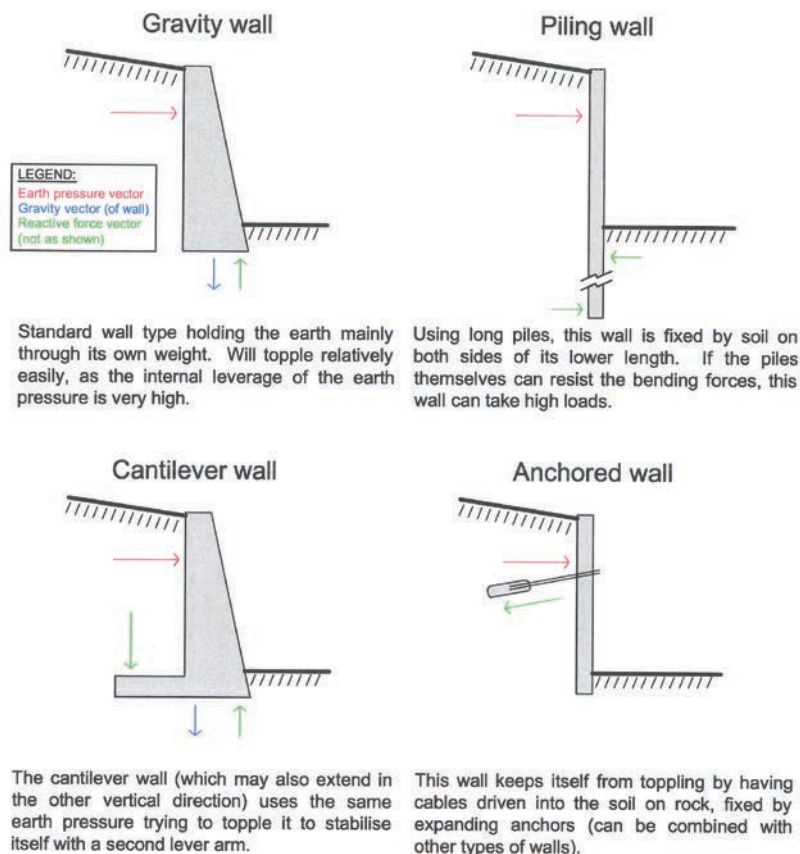

Most wall structures will require a building consent to confirm that they function correctly and are in accordance with the Building Code. Choosing to ignore this requirement can put the farm owner at risk.

### 7.1.1 Segmental retaining walls

Segmental retaining walls are an option (as illustrated in Figure 7.2) where earth needs to be retained such as for roads, bridge abutments, culverts and underpasses. These are gravity retaining walls that rely primarily on their mass for stability. The system consists of concrete masonry units which are placed without the use of mortar and rely on a combination of mechanical interlock and mass to prevent overturning and sliding. The units may also be used in combination with horizontal layers of soil reinforcement which extends into the backfill to increase the effective width and weight of the gravity mass. Unlike rigid retaining wall structures which may crack when subject to movement, the flexible nature of these types of walls allows the units to move and adjust without visible signs of distress. However, they are unsuitable as liquid or bulk containment structures.

Figure 7.2: Segmental Retaining Wall (SRW) Options

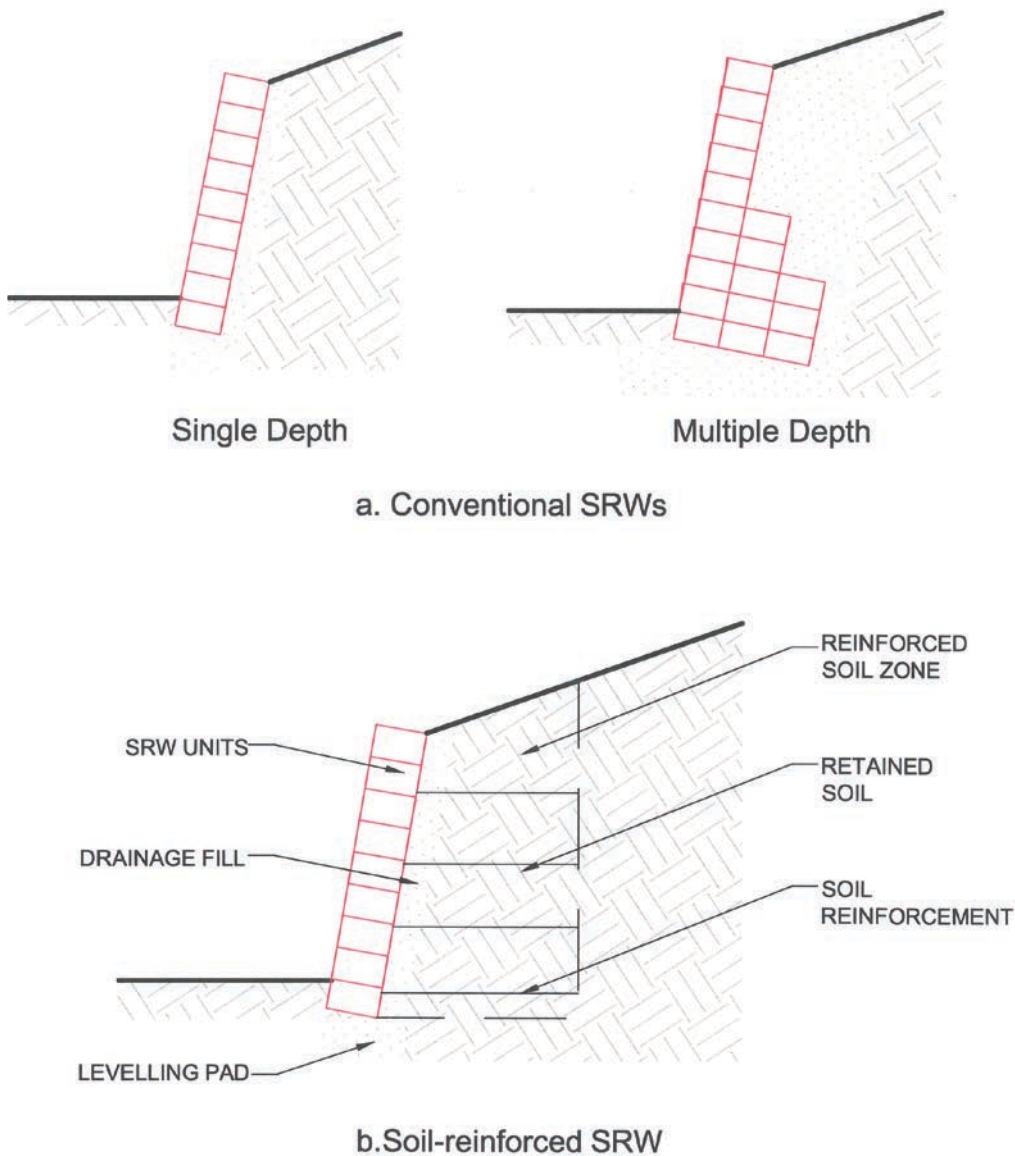

## 7.2 SIMPLE BUILDINGS

Most building structures are required to comply with the Building Code which requires that all sources of imposed loads are considered. These could be categorised as use (human, animal, mechanical) and environmental (wind, snow, seismic loading etc.). Their structural frame may be of timber, steel or concrete (or in some cases aluminium or alloys).

## 7.3 STORAGE STRUCTURES

Storage tanks, sumps and bunkers for solids, semisolids or liquids can take many forms but are typically constructed from reinforced or prestressed concrete, either cast *in situ* or precast.

The most common type of storage structure employed on farms is a circular (or square) tank generally formed into the ground so that the outer walls are partially supported by the soil. The walls are normally formed with precast concrete sections, which are erected onto a reinforced concrete ground slab or platform, and joined together with some form of capping beam. These can be very cost effective, but it is important that they are designed correctly to ensure that they are capable of containing the fluids without leakage. Tanks can often be supplied with a roof made from lightweight materials such as steel and corrugated sheeting, or from heavier precast concrete sections.

Critical in the design of storage structures is appropriate design for the ground conditions in or on which the structure will sit. *Practice Note 21* Part 4 provides guidance for the design and construction of ponds and tanks built on peat.

The design of reinforced and prestressed concrete for the storage of liquids is specified by NZS 3106. This standard makes requirements for the designer to consider the loading effects of the stored liquid, and the condition when the tank is empty. It also requires that the loads imposed by wind and snow are considered, as well as seismic loading. Fluids tend to “slosh” in a seismic event and will impose extra loadings onto the walls and foundations of the tank.



*Storage tank, precast reinforced concrete panel construction*

Tanks containing FDE will require a higher liquid tightness (crack control) than those carrying only water in order to meet permitted regional council leakage (seepage) rates. “Off the shelf” concrete tanks designed for the storage of water may not be suitable for other liquids. Tanks designed as free-standing may not be designed for being buried in the ground and having fill materials compacted up against them, especially if they hold FDE. NZS 3106:2009 Table 3 shows liquid tightness classes and tightness standards. A method for testing of liquid retaining structures is shown in NZ 3106: 2009 Appendix C3.

Another important consideration is the temperature effects on the tank. Tanks can be very exposed, and temperature changes cause concrete to swell and shrink. This may induce significant cracking if the concrete has not been designed to cope with changes in temperature. The expansion and contraction of the individual elements of a concrete tank can also impose significant loads on other parts of the structure and these loads need to be considered and evaluated.

## 7.4 FOUNDATIONS

Buildings require foundations to transmit the loads into the ground and to maintain and support the building. Simple buildings may have timber or steel posts connected to a concrete base, or be socketed, or posts embedded into the ground below with a concrete surround.

*Table 7.1: Considerations – Foundation Post Design*

Considerations – Foundation Post Design
<ul style="list-style-type: none"> <li>• Ground conditions</li> <li>• Ground water level</li> <li>• Post type – timber or steel</li> <li>• Post treatment</li> <li>• Post diameter and length</li> <li>• Hole depth and diameter</li> <li>• Concrete strength.</li> </ul>

To design foundations and specify a suitable floor slab, it is critical that subsoil conditions including ground water level are considered. This will require some form of site investigations prior to the design being undertaken. In farm conditions, it is particularly important to consider the risk of ground contamination due to the presence of fertiliser or other acidic or sulphate-rich materials. These can attack the concrete or cause the ground under the concrete to heave. Good quality hard fill for placement under the slab may also need to be sourced.

## 7.5 FLOOR SLABS

Some buildings will require the support of a concrete pad foundation, which may or may not be reinforced, depending upon the loading requirements and the subsoil conditions. Others are able to be founded on a reinforced concrete ground slab which can serve as the floor as well as the support of the building. Commonly, the slab is thickened at the edges to assist with the support of the building

The general exposure of concrete to sun in the summer months, and frost, ice and snow in the winter months can significantly influence floor slab durability (see section 4.1). If not designed for, thermal movements can create problems over time.

For a storage facility or hard-standing area where trucks or other large vehicles may have access, a site specific concrete ground slab may need to be designed. The *in situ* ground conditions in the area where facilities are placed also need to be considered to ensure that any long-term uneven concrete settlement will not affect surface drainage flow paths.

Part 5: Feed Pads, describes in detail considerations for concrete slabs specifically for feed pads. These are equally relevant for floor slabs for other functions around the farm. *IB 55* section 4.0 further describes general design and construction issues for concrete slabs.

A common construction defect following the completion of concrete slabs for stock standing areas is the inadequate reconstruction of the junction area where gravelled entry or exit races meet at the concrete. It is important that a suitable contractor:

- Digs out unsuitable race material
- Installs drainage, for example subsoil drains or surface water channels
- Places sufficient depth of compacted gravel
- Compacts and trims the race surface.

Without good race construction, stormwater can flow onto this junction area, and with cow hoof action cause the race surface and underlying pavement to deteriorate.

## 7.6 NIB WALLS

Nib walls (also known as kerbs) create an edge to storage areas for:

- Channelling FDE and stormwater away to drainage collection
- Retaining thin layers of solid or semi-liquid material (such as FDE on concrete races)
- Providing a hard edge for machine pickup or scraping against.

To ensure the nib wall is fit for purpose, careful consideration should be given to the intended use of the wall prior to deciding how it should be constructed, for instance:

- What materials are to be retained? Specifically, consideration should be given to the likely durability of the concrete in contact with these materials
- How will material be removed – along the wall or by digging towards the wall?
- Will the removal be by hand or machine, for example, a front loader?
- What are the drainage requirements?
- What washing down arrangements are proposed?

From these and other use considerations, a brief for the design of the nib wall can be developed. Depending on its use, a nib wall can be constructed in either reinforced blockwork or concrete. The use of unreinforced building materials is not advisable as they tend to be unable to withstand horizontal forces from mechanical equipment.

Nib walls should be constructed with a suitable foundation to ensure they have the ability to resist the forces imposed on them without overturning. This will generally mean some form of slab foundation which will extend out on both sides and may well be connected to the base slab of the loading area or farm building which they serve.

In addition, *NZCP1: Design and Operation of Farm Dairies* makes the following points in Table 7.2 in respect to kerbing.

*Table 7.2: NZCP1: Code of Practice for the Design and Operation of Farm Dairies section 4.2, Kerbing*

#### 4.2 Kerbing

- (1) The perimeter of all the yards and of all races, concreted as required in clause 4.1 Floors, Yard Surfaces and Races, must have a kerb which is a minimum of 150 mm above the level of the surface of the yard. The exception is where kerbs can be reduced to 50 mm at the yard entrance area and bail exit area. The kerb must be made of concrete or another similar material.
- (2) Coved kerbing is effective, easy to clean and is less likely to cause injury to animals. The purpose of a kerb around the yards and at the sides of concrete races is to prevent soil and dung being washed over the sides of the yards and races.
- (3) The 50 mm kerb nib across the end of the race will help prevent soil and dung from being brought into the yards and may prevent yard washing water from causing heavy pugging at the end of the concrete race.

Recommended dimensions for nib walls over which cows are expected to walk are a square (not rounded) step 50–75 mm high and 300 mm wide.

*Figure 7.3: Correct (and Incorrect) Nib Wall Design*

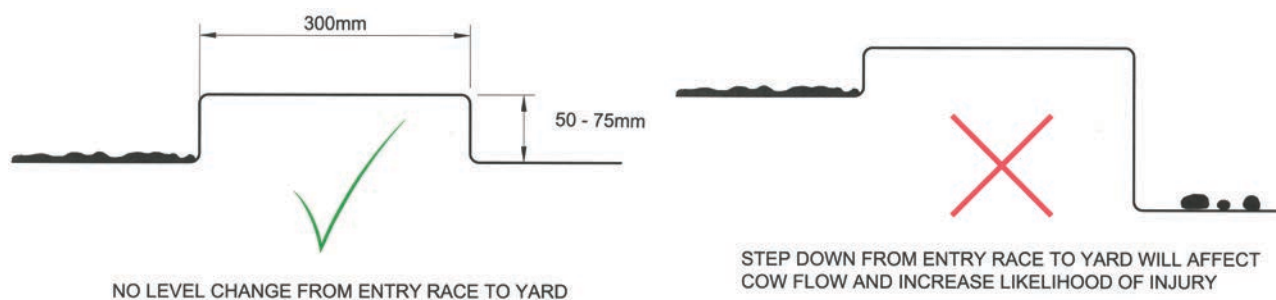

## 7.7 SURFACING

Concrete surfaces subject to stock traffic, such as races and feed pads, might appear to be simple structures, but need to be specifically designed, considering the factors listed in Table 7.3.

*Table 7.3: Concrete Surfacing Considerations*

#### Concrete Surfacing Considerations

- Incorporate water and waste collection into the floor design
- Determine the required texture (rough for good grip, smoother for easier cleaning, or somewhere in between)
- Design in sufficient slopes across floors to ensure adequate drainage and to facilitate washing
- Ease of maintenance, cleaning and loading out from
- The required service life of the structure
- Containment and reticulation of FDE, and stormwater (if not roofed).

### 7.7.1 Floor slopes

FDE accumulates on concrete floor slabs on which cows walk, eat and rest. Therefore, floor slabs and associated surfaces need to be cleaned regularly by hosing and/or scraping. All surfaces should be easy to clean and provide sufficient slip resistance when wet or covered in FDE. Permanently wet floors can increase cow lameness, impede cow flow and reduce hoof hardness. They can also increase the floor's susceptibility to abrasion and to chemical attack from acidic dairy effluent or leachate from silage. A fall across the surface of 2 per cent or greater will prevent water, FDE and aggressive fluids ponding in localised depressions. Table 7.4 provides further guidance on floor slopes.

*Table 7.4: Yard Slope and Drainage Typical Values*

Yard Slope and Drainage Typical Values
<p>The degree of slope in a holding yard can affect cow flow and comfort. It also has an effect on cleaning and drainage.</p> <ul style="list-style-type: none"> <li>• 3% to 4% slopes (1:33 to 1:25) angled towards the dairy, encourage cows to face the dairy, and are also better for cleaning</li> <li>• Greater than 4% slopes (1:25) lead to increased wear at the yard-platform intersection. As the concrete wears smooth, the incidence of slips and falls will increase. Steep upward slopes also cause weight to be transferred from the cows' front to rear legs which is undesirable as it can result in injury</li> <li>• Where steep upward slopes are unavoidable, steps are preferable to a slope. Cows prefer to walk up well constructed steps than on a steep slope because their foot placement is onto a safe level surface</li> <li>• Cows are often reluctant to go down slopes exceeding 5% (1:20). Steps will provide surer footing and cows will flow far more readily than down a sloped ramp.</li> </ul>

### 7.7.2 Slippery floors

Slippery floors such as from new or smooth-surfaced concrete may also cause sideways pressure on hooves or cow sole injury. There are many industry options available for improving traction and reducing slippage on concrete floors including grooving and rubber matting. Grooving is more durable than a raised texture.

One successfully used approach is to level and smooth the fresh concrete surface, apply a broom finish, and after curing, grind off the sharp edges by dragging a concrete post or similar over the surface. A few weeks after placement for new surfaces, or for existing slippery surfaces, arrange for a diamond wheel concrete grooving contractor to cut sharp-square groove patterns into all cow flow areas. Grooving needs to take place when the facility is not being used by stock because of the significant noise, dirt and waste water created during the work.

Acid etching, a process in which an acid solution is applied over a concrete surface exposing sand and fine aggregate and giving a sandy grainy texture, is not recommended as it does not provide an effective means to reduce floor slipperiness for cows.

In the UK to provide skid resistance for cows walking in variable directions and to eliminate the adverse effects of high pressures on the hoof, a hexagonal pattern as shown in Figure 7.4 can be formed in newly laid concrete. The hexagonal pattern can be created by tamping a pre-formed rubber template into the floor and removing the template as the concrete cures. If cow flow is one directional, parallel grooves can be formed on the concrete at right angles to cow movement.

If an existing floor is to be improved, it is normal to adopt either parallel grooves if cow flow is in one direction, or a pattern of regular squares or diamonds if the movement direction is more random. For long feed pads and yards with a grade of 2 per cent or less, grooves should be in the down slope direction to assist with drainage. For ramps and surfaces with grades of 4 per cent or more then the grooves should be cross slope to provide maximum hoof friction.

Groove depths should be a minimum of 6 mm deep but usually not more than 10 mm. Any increase in depth attributable to the pattern upstand should be discounted when considering minimum cover to steel reinforcement.

Parallel grooves have been found to be preferable, as squares and diamonds increase the number of pressure points on the cow’s foot without any benefit in slip resistance.

Figure 7.4: Concrete Floor Pattern Options

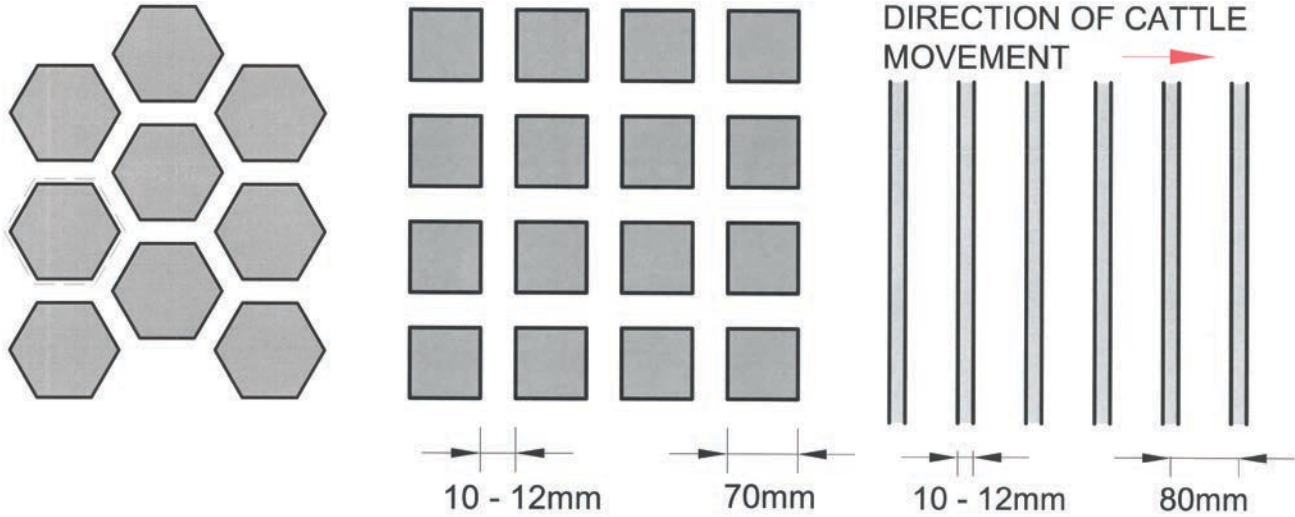



## 8. STRUCTURAL ENGINEERING GUIDANCE

---

For all types of construction, except for the very simplest, it is recommended that the farm owner/client discuss the project at the outset with a CPEng to identify the technical requirements and agree on a brief for the work. In most circumstances, this will lead to a clearer understanding of the project and how it may best be developed to the benefit of the farm. In many cases, a simple consultation may be all that is required. In other cases, the client will be able to develop a brief with the designer to ensure that the project proceeds smoothly with the best advice and without unnecessary expense.

The time taken to produce designs and obtain Building Consent Authority approval can be crucial to project delivery, as will be the economics which govern it. This can be discussed with the designer at the outset so that a realistic programme, scope of work and fee can be agreed to.

Furthermore, it is wise for the farm owner to take independent advice to confirm that a concrete product proposed by a product supplier will deliver the intended outcomes and will not create structural or durability issues in the future. Usually a building consent will be needed, requiring a CPEng to certify designs by means of a Producer Statement – Design (PS1). A CPEng will also be required to monitor the construction and confirm its compliance on completion by issuing a Producer Statement – Construction Review (PS4).

Reinforced concrete design should be reviewed by a CPEng with competence in structural design. They are bound by ethical guidelines to only engage in work that they are competent in. IPENZ has a process for holding engineers to account if they do not fulfil their ethical obligations.

Farm structures are a significant investment and they must be well designed, durable and fit for purpose. Repairs and replacements can be costly in terms of both time and money. It is therefore important for the farm owner to obtain the right professional advice from the outset.

# 9. APPENDIX:

## 9.1 CCANZ INFORMATION BULLETIN: IB 55



### CONTENTS

1.0	Introduction	1
2.0	What's Special about Concrete on the Farm	1
3.0	What Concrete is Made From	2
4.0	Design and Construction Issues for Concrete Slabs	7
5.0	Getting Ready to Build	10
6.0	Planning for Concreting	10
7.0	Placing Concrete	15
8.0	How to Choose and Supervise a Contractor	20
9.0	References	21
	Appendix A	22
	Appendix B	23

### 1.0 INTRODUCTION

Concrete is an extremely versatile material that lends itself to many uses, from major civil structures such as dams and viaducts, to small, highly engineered units such as pipes and utility poles, to relatively low tech uses such as domestic paths and supports for fence posts.

However simple or complex the application, the concrete needs to meet certain expectations. The builder needs just the right consistency and setting time to cast the required shape and produce the desired surface finish. Once cast, the concrete needs to gain strength fast enough for the next stages in construction to proceed. Finally, the concrete needs to be strong enough for the structure to withstand applied loads with no loss in performance, and it needs to be durable so that its performance is maintained throughout the life of the structure.

On the farm, concrete is often used in relatively small and simple structures so it is easy to think that its performance is not as critical as in more complex structures like motorway bridges and high rise

buildings. Nevertheless, concrete structures such as milking shed floors represent a large investment, and decommissioning and replacing or repairing a damaged or inadequate concrete structure can involve considerable time, inconvenience and expense. In addition, some structures on the farm are exposed to conditions that may rapidly damage concrete of inadequate quality.

Good concrete and bad concrete are made from the same materials. This IB explains how to design, mix and place concrete so that concrete structures on the farm will last as long as intended. It concentrates on concrete that is cast in-situ, rather than masonry, precast concrete products, roading materials or cement stabilised soil.

For further information refer to the list of CCANZ and other publications at the end of this IB.

### 2.0 WHAT'S SPECIAL ABOUT CONCRETE ON THE FARM

Concrete is used for many applications on the farm that are no different from other residential or civil structures, for example driveways, footpaths, drinking water supply, septic tanks, culverts, and bridges. The same materials and practices can be used to build these structures on a farm as anywhere else.

Some farm operations however are quite corrosive to concrete. Concrete is an alkaline material and is attacked by the acids in manure, milk and silage. Acid attack softens the exposed surface of the concrete so that it is easily worn away by water or abraded by hooves, vehicles, steel wheels and scraping machinery. Thus concrete floors or races exposed to manure will abrade faster than floors and paths not exposed to acid, and the floor of a silage pit subject to scraping by front-end loaders will wear more than a concrete floor used to store dry materials.

The roughened, more porous surface that results from acid attack will trap dirt, creating a hygiene problem or making the surface slippery for animals and people to walk on. Stones protruding from the damaged concrete can inflict injury to stock and

damage equipment. Concrete in this condition may be unacceptable to the user, even though the structure itself is still strong enough.

Acid environments on the farm can be just as corrosive as industrial sites such as food processing plants and waste water treatment plants, where special concretes or surface treatments are often specified to protect concrete surfaces exposed to acid. On the farm, however, the structure may be smaller and easier to replace (such as precast cattlestops or grids over effluent traps), or not expected to last as long. So although conditions on a farm may be corrosive, a lower level of protection than on an industrial site may be acceptable.

Many structures on the farm need to comply with the New Zealand Building Act (2004). The New Zealand Building Code provides the means of complying with the Building Act. New Zealand Standards for light timber framed construction (NZS 3604), concrete structures (NZS 3101), concrete supply (NZS 3104) and concrete construction (NZS 3109) provide acceptable solutions to the requirements of the New Zealand Building Code. Structures that are covered by the Building Act must be built in accordance with either these Standards or alternative solutions acceptable to the approving territorial authority, including all aspects relating to concrete.

This IB primarily aims to satisfy requirements for structures covered by the Building Act (2004). No harm will be done in following its recommendations for minor concrete work such as footpaths, mowing strips and patios around the house that are not covered by the Act, and in fact significant benefits may be obtained for the slightly greater cost involved. However, it also acknowledges that concrete that would not be accepted for structures covered by the Building Act, may be perfectly acceptable for this type of minor work, and so it also gives guidance for such applications.

## 3.0 WHAT CONCRETE IS MADE FROM

### 3.1 What is Concrete? What Makes it go Hard?

People sometimes use the term cement when they mean concrete. Cement is the powder which when combined with water forms the 'glue' in concrete. It is the most expensive ingredient in concrete. However, when we are referring to site operations, typically we should be using the term 'concrete'.

Concrete is a mixture of sand and gravel held together by a binder containing Portland cement. The binder is formed by mixing Portland cement and water, which combine to form a hard, stone-like mass. A wide variety of concrete properties can be obtained by blending different amounts and types of sand, gravel, cement and water, sometimes with the addition of other materials as well.

Fresh concrete has a fluid or plastic consistency. It remains mobile for a limited time, during which it is worked into the required shape. The mobility of fresh concrete is known as its "workability". Workability is measured by a test called the "slump test". The higher the slump, the more fluid the concrete. Most farm concrete is supplied with a slump around 100 mm.

The hardening process begins with the concrete losing its mobility. This is known as "setting", and generally takes a few hours once the concrete is mixed. Until the concrete has "set" (or "gone off") it can be placed, moulded, compacted and finished without difficulty and is said to be "workable". Once the concrete starts to set it must not be remixed.

Once concrete has set and can no longer be worked, it remains weak and easily damaged and needs to develop strength before it can be put into service. Concrete that has not yet developed significant strength is often referred to as "green concrete". The strength development process is known as "hardening". Concrete develops about three quarters of its ultimate strength in around a week depending on conditions. Most of its strength is achieved after a month, although hardening can continue indefinitely in the right conditions. Concrete strength is therefore defined as the compressive strength of laboratory samples tested 28 days after they are cast. Compressive strength at 28 days is the property most often used to distinguish different types of concrete.

Concrete sets and hardens not by drying but by chemical reaction between Portland cement and water. It will even set and harden under water. Drying will not make concrete set and harden faster or stronger, in fact it will do exactly the opposite because it removes one of the chemical reactants. Consequently it's very important to prevent concrete from drying at early ages. There are several ways to ensure that sufficient water is retained in new concrete – these processes are collectively known as "curing".

Heat speeds up the chemical reactions involved in

setting so concrete sets faster in warm weather and slower in cool weather. Warm temperatures will increase also initial strength development but the rate of hardening will then slow. Concrete hardened at elevated temperatures is ultimately weaker than concrete made from the same mix type cured at lower temperatures. At temperatures less than about 5°C, however, strength development is negligible. Temperature is therefore a critical factor in concrete construction, determining the times at which concrete is finished, formwork is removed and the structure put into service.

### 3.2 What is Concrete Made From? How do the Ingredients Affect the Final Product?

#### 3.2.1 Water

NZS 3121 *Water and Aggregates for Concrete* requires that water used to mix concrete must not contain impurities that affect the setting or hardening of the cement or the strength or durability of the concrete. Potable water, including drinking water supplied by local authorities is suitable for use in concrete.

Ready mixed concrete suppliers recycle wash water, from cleaning of truck mixers and general ready mix plant cleaning, as mix water into subsequent batches of concrete. This water is very alkaline and cannot be discharged into the environment.

A certain amount of water is required for the chemical reaction with cement. To make the concrete suitable to mould into shape however, extra water is required. This poses a dilemma because as more water is added the ultimate strength of the concrete decreases and the ultimate permeability of the concrete increases. **Figure 1** shows how concrete strength decreases rapidly with increases in the ratio of water content to the cement content. W/C is an often used ratio to characterise a particular concrete. **Figure 2** shows how the concrete's permeability increases with the ratio of water to cement.

What have water content, strength and permeability got to do with concrete in the farm situation?

Strength is required for the concrete to carry load without distorting or cracking. It also provides abrasion resistance. Permeability indicates how easily liquid can penetrate the concrete, so the more permeable the concrete the more it will absorb water and liquid chemicals that attack the concrete.

Neither the cow, the farmer nor the concrete expert can tell the difference between a weak or permeable

concrete floor and a strong or impermeable concrete floor just by standing on it, but repeated exposure to abrasion or aggressive chemicals will quickly show up any deficiencies.

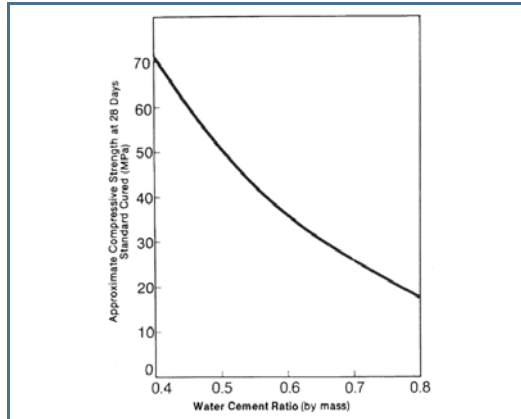

**Figure 1:** Approximate compressive strength of concrete made with various water/cement ratios

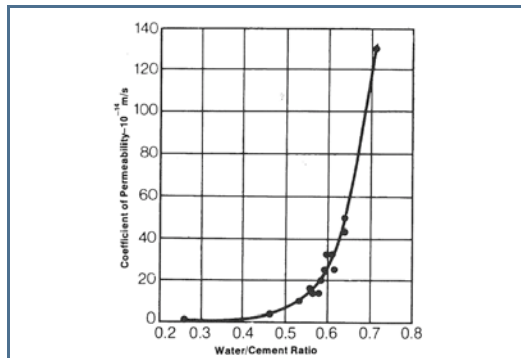

**Figure 2:** Relationship between permeability and water/cement ratio for mature cement pastes

Hooved stock or steel wheels on a gate will soon abrade a path in a weak floor surface.

Acid cowshed waste will quickly penetrate and soften the surface of a poor quality concrete floor so that it is easily worn away by cattle walking over it. The less permeable the floor the better it will be able to resist acid attack.

The concrete's workability can also affect strength and permeability:

- Too little water and the concrete will be too stiff to place and compact properly, leaving voids in the hardened concrete that will reduce its strength and increase its permeability.

- If the mix contains too much water the cement and water mixture will be too liquid to support the sand and gravel, which fall to the bottom of the concrete, leaving a cloudy liquid on top. The bottom part of the hardened concrete will not contain enough cement binder so will be weak. The top part will have too much water so will harden to form a weak, cement rich layer known as “laitance”, which will crack as it dries out and be quickly abraded.

The ultimate strength and durability of concrete thus depends largely on the amount of water used to make it. Because of these effects, ready mix suppliers closely control the amount of water added to the concrete and only a small amount is permitted to be added if the concrete is too stiff to place easily when it arrives on site. Just as much care must be taken not to add too much water to site-mixed concrete.

Mixes designed to be placed by concrete pump tend to have smaller aggregate and may be more prone to shrinkage, but this should not be problem if the structure is well-designed and the concrete properly placed.

### 3.2.2 Sand and Coarse Aggregate

Sand is termed “fine aggregate” and crushed aggregate or gravel (natural aggregate) is known as “coarse aggregate”. Sand and Coarse Aggregate are collectively known as “aggregate”. NZS 3121 requires aggregates to be free from significant quantities of materials that may affect the performance of fresh or hardened concrete. Such materials include:

- Low density materials such as coal, lignite, shale and pumice that may float to the surface of the fresh concrete.
- Soft, friable, or heavily weathered materials or layered materials with poorly bonded bedding planes that will disintegrate under load.
- Materials with smooth surfaces or surface coatings that prevents them bonding to the cement paste.
- Insoluble organic impurities such as wood, seeds and waxy or oily materials.
- Water soluble impurities such as salt from seawater or sea spray, urine or sugar.

The main role of aggregate is to restrain shrinkage imparted by the cement paste. It also takes up to 75% of the concrete volume and acts as a cheap filler. Ready mixed concrete normally has a maximum aggregate size of about 20 mm. Concrete made from smaller sized aggregate will require more water

and may shrink more after it has hardened. Ready mixed concrete plants grade their aggregates to give a particular proportion of sand and coarse aggregate particles of each size in the aggregate.

Controlling the particle size distribution in this way ensures that the particles of aggregate pack together closely with as few voids as possible. The right grading will ensure that the minimum amount of water needs to be added to achieve a workable concrete mix and therefore the maximum strength and minimum permeability can be achieved.

The shape of the aggregate particles is also important. Particles with smooth surfaces will not bond as well to the cement as particles with broken surfaces. On the other hand, well rounded particles are more mobile in a concrete mix and require less mix water.

For site mixing the best results are obtained by purchasing coarse and fine aggregates separately, although use of ‘builders mix’ is catered for, albeit a higher cement content is required for a given design strength. See 3.3.2 and **Tables 1 and 2** in the Appendix. Use sand specifically designed to be used in concrete – the gradings and particle shapes of “builder’s sand”, “bricklayers’ sand” or “plasterer’s sand” are not suitable.

Builders’ mix contains both sand and gravel. NZS 3104 Part 3 specifies grading requirements for builders’ mix. Builders’ mix used in concrete for structures covered by the Building Act must meet these requirements but the quality will vary between producers. It should look clean, without dust or silt, with about 60% of the particles bigger than 5 mm. If it’s too sandy or gravelly extra coarse aggregate or sand can be added, but this is neither convenient nor reliable. NZS 3104 Table 3.2 has a grading envelope for compliance of builders mix.

Natural deposits of sand and gravel may be available on the farm. These deposits will tend to be made up of aggregate particles of similar size so relatively large gaps will remain between the particles when they are packed together in concrete. Silt and clay present in such aggregates can cause low strengths because their large surface area increases the amount of water needed. Aggregate sourced from the farm may be suitable for concrete such as garden paths that are not exposed to heavy loads, abrasion or chemical attack, but is unlikely to be suitable for construction structures used by farm stock.

### 3.2.3 Cement

Most concrete is made from a particular type of cement known as General Purpose portland cement

or 'Portland cement' for short. In this IB "cement" refers to Portland cement unless otherwise stated. Cement used for site mixing is supplied as a bagged product. In New Zealand the minimum quality of cement for use under the Building Act is prescribed by NZS 3122. Compliance with NZS 3122 is a guarantee that the cement will perform to the required level and is labelled as compliant on the bag. All New Zealand-made cements comply with NZS 3122. Imported cements (which may be bagged in New Zealand) may or may not comply with NZS 3122.

Cement is formulated in several different compositions to produce properties suitable for different purposes. Most cement used in New Zealand is Type GP (general purpose). Type HE (high early strength) cement may be useful for faster strength development at early ages in colder weather. Type GB (general purpose blended) is often used where extra chemical resistance is required, and is suitable for corrosive farm applications such as dairy floors and piggeries.

Provided that the correct amount of water is added and the concrete is placed, compacted and cured properly, concrete made from a particular brand and type of cement will be consistent from mix to mix. Different brands of the same type of cement will, however, give different properties so it is best to stick with exactly the same cement throughout a project. This means bulk buying all the cement needed for site mixing for a complete project. The alkaline cement binder is attacked by acids and other chemicals so there must be enough binder present to allow for some to be sacrificed without the concrete becoming unfit for service. Having enough cement binder also minimises the voids between aggregate particles, reducing the concrete's permeability. Although concrete is usually specified by the minimum compressive strength required, concrete subject to attack by acids and other chemicals is also required to have a minimum cement binder content (see Section 3.3).

The less accurately the cement is measured the greater the amount that has to be added to ensure that there is enough in the concrete to give the required strength and chemical resistance. Ready mixed concrete suppliers measure all their ingredients by weighing batching subject to strict quality control. Site batching on the other hand is measured by volume batching which is less accurate. Thus mix designs for site batching require more cement to compensate for the low batching accuracy when compared to ready mix design (see Section 3.3.2).

Cement binders may also contain cementitious materials other than Portland cement that are added

to the mix to improve its properties. These materials react with water and the products of the cement-water reaction to supplement the cement binder produced by the Portland cement so are known as "supplementary cementitious materials" (SCMs). Ready mixed concrete suppliers can add SCMs to concrete that needs to have extra durability, such as reinforced concrete that will be exposed to windblown marine salts or any concrete exposed to acidic conditions. SCMs are not suitable for site batching because they are very fine powders that present a safety hazard, must be batched by weight and be thoroughly blended with the other mix ingredients, which may be hard to achieve on site.

### 3.2.4 Admixtures

The properties of the cement binder can be modified by chemicals added to the mix. These are known as "chemical admixtures". They may be used to improve concrete workability without adding extra water, make concrete set faster in cold weather, set slower in warm weather or for long delivery times, or entrain air into the fresh concrete to improve its workability so less cement and water are needed. An air entrainer is also used in concrete subjected to frost to prevent scaling of the exposed surface. Almost all ready mixed concrete contains at least one admixture to optimise concrete properties and price. Admixtures can be added to ready mixed concrete at the site if necessary to improve workability.

Chemical admixtures should not be used in site mixed concrete however, because both the cement and admixture must be measured very accurately to achieve the desired effects.

### 3.2.5 Pre-bagged Dry Mix Concrete

Proprietary pre-bagged concrete materials are available from hardware and builders suppliers. These contain pre-weighed amounts of graded and dried aggregate, cement and additives. The user simply has to add water. Each bag makes one to two 9 litre buckets full of concrete.

Pre-bagged products are available for many different purposes, from general purpose concrete to concrete that sets almost instantly. They are designed for the home handyman or the contractor who mixes small amounts of concrete at a time and wants to avoid setting up for site mixing. Their most common use is as foundation concrete for fence posts.

Normal-setting pre-bagged concrete is suitable as General Purpose 15MPa concrete. Rapid set products are suitable for bedding concrete.

Different manufacturers produce concretes of different strength and setting behaviour so read the product specifications, select a product suitable for the particular job in hand and use the same product for the whole job.

Pre-bagged concrete cannot be used for structures to be compliant with the New Zealand Building Act.

### 3.3 How Much of Each Raw Material Goes into Concrete?

#### 3.3.1 The Purpose of a Mix Design

Whether the chosen materials produce good concrete or bad concrete almost always depends on the proportions in which they are combined, i.e. the "mix design".

Section 3.2.1 showed how extra water reduces strength and increases permeability, and Section 3.2.3 mentioned that extra cement improves chemical resistance. Figures 1 and 2 showed that the strength and permeability are closely related not just to water content but to the ratio of water to cement.

Ready mixed concrete suppliers have a series of mix designs optimised to give a range of concrete properties with their aggregates and preferred cement to suit common methods of placement, finishing requirements, setting times, rate of strength development and final strength and permeability.

Similarly, when site mixing the materials can be combined in different proportions to give a range of strengths and permeabilities.

#### 3.3.2 Mix Designs for the Farm

Concretes suitable for farm applications can be grouped into five categories:

**Mix A: Wet corrosive (30 MPa):** for concrete exposed to acidic materials in wet conditions, such as dairy floors, stock races, piggeries, silage stores, structures for collecting manure;

**Mix B: Roadways, buildings and foundations (25 MPa)\*:** used for roadways where wear and abrasion is expected and for buildings and foundations.

**Mix C: General Purpose (17.5/20 MPa)\*:** used for general construction complying with New Zealand Building Act requirements.

**Mix D: General Purpose (15 MPa):** used for unreinforced concrete in footpaths, implement sheds, storage of hay and other dry materials etc. It is not Building Act compliant.

**Mix E: Bedding Concrete (10 MPa):** used for unreinforced concrete to bed in items like fence posts. It is not Building Act compliant.

Mix designs that will deliver the minimum quality of concrete appropriate for each of these uses are given in **Tables 1 and 2** in the Appendices.

*\* Note that where construction is subject to a building permit and comes under the New Zealand Building Act, you must use either Mix A, Mix B or Mix C. Mix A must be supplied from a ready-mix concrete plant compliant with NZS 3104.*

Under the terms of the New Zealand Building Code, structural concrete is required to perform as designed for at least 50 years without needing reconstruction or major renovation. NZS 3104:2003 specifies a minimum of 17.5 MPa for structures subject to New Zealand Building Code requirements. The actual specified strength is determined from the most critical of a number of factors:

- The concrete strength used in design.
- The abrasion resistance required.
- The chemical resistance.
- The type of finish required.
- The durability for the particular environment of the structure.

Typically in New Zealand, the durability of exposed concrete is based on the ease with which wind-blown marine salt can penetrate the concrete. If salt can reach the reinforcement in sufficient quantity, the reinforcement will corrode. Durability can be improved by increasing the concrete strength and/or the cover (or depth) of the reinforcement. In this regard it is recommended that the concrete strength requirements of NZS 3604 be followed:

- Inside concrete protected from the weather, 17.5 MPa.
- Exposed to the weather but not coastal, 20 MPa.
- Within 500m of the coast (refer NZS 3604), 25 MPa.

Considering factors other than marine durability, the minimum strength should be 25 MPa for high wear

areas, or for areas subject to milk or waste spillages, 30 MPa.

Construction drawings and specifications may quote the concrete strength required. This is important for structural purposes but may not provide enough resistance to chemical attack. Consequently for concrete exposed to acids and other aggressive chemicals there are additional requirements. These are generally met by using more cement, and/or a Type GB cement or an SCM.

As outlined above, concrete exposed to farm waste material should require a higher strength, 30 MPa. NZS 3101, Section C3, gives guidelines for concrete exposed to aggressive ground conditions which can attack concrete.

Non-structural concrete is required to last at least 15 years. 15 MPa concrete may be adequate for non-structural concrete which is not exposed.

### 3.3.3 Value for Money

The price of concrete increases with an increase in the cement content. The stronger and less permeable the concrete the more cement it contains and the more it costs. The price increases again with the use of Type GB cement or SCM, so more durable concrete costs more than concrete that only targets strength requirements.

The cement contents given in **Appendix A Table 1** are designed to make concrete that is easy to mix, place, compact and finish and have appropriate strength and durability. It may be tempting to save money by choosing a cheaper concrete but doing this is likely to result in concrete that is difficult to compact and finish and wears poorly once hardened.

In practice the price difference is often a small proportion of the project costs. For example, the cost of 17.5/20 MPa ready mixed concrete comprises 5-6% of the total cost of building and equipping a new 60-head rotary dairy facility. 30 MPa concrete is about 10% more expensive than 17.5/20 MPa concrete, but increases the total project cost by only 1%.

30 MPa concrete containing an SCM or Type GB cement may be around 1.4 times the cost of 30 MPa concrete without SCM. In the example above, the difference in price between these two concretes represents about 3% of the total project cost.

Concrete in dairy sheds and other such wet corrosive environments will be exposed continuously to the aggressive chemicals throughout the life of the structure. Although it may be possible to reinstate the concrete surface once the damage becomes significant, such repair is expensive and the facility

cannot be used while it is being carried out, which could take several weeks. It may be argued that most of the at-risk structures are likely to be obsolete and require significant modification within the 50 year service life specified by the New Zealand Building Code. But building for a shorter period reduces room for error and may also limit the options for re-use of the structure when it is eventually upgraded. The higher cost of the better quality concrete is therefore readily justified.

## 4.0 DESIGN AND CONSTRUCTION ISSUES FOR CONCRETE SLABS

Concrete slabs are possibly the most common type of concrete construction on the farm, whether they are footpaths, stock races or floors. This section introduces some of the issues related to the design and construction of concrete slabs. For a more complete description see the CCANZ and BRANZ publications on concrete floors listed in Section 9.

All residential slab-on-ground floors must be reinforced with reinforcing steel or welded wire mesh to Ductility Class E to AS/NZS 4671. The steel from which the mesh wires are made is ductile and will stretch across cracks in the concrete before it breaks.

### 4.1 Preparing the Ground

Before laying any concrete slab, whether for a floor, path or road, the ground must be prepared. All top soil, rubbish, noxious matter and organic must be removed and soft spots dug out.

The sub-base should be levelled to provide the amount of fall needed to drain surface water from the slab. Typically 1:50 (20 mm per metre) is the minimum gradient required for a smooth and accurately finished surface; 1:40 (25 mm per metre) is better for textured surfaces. A method of taking the surface water away from the structure must also be provided, e.g. a drain or soak pit. An example is given in **Figure 3**.

If casting directly onto the ground, the ground under the slab ("sub-base") must be compacted. It may need to be dampened before casting so that dry ground doesn't suck water from the concrete.

A layer of granular fill may need to be placed over the sub-base to raise the finished level of the concrete to the required height above ground and to prevent water wicking up through the concrete. The granular fill should have a good particle size



distribution – aggregates meeting Transit New Zealand grading requirements for AP 20 and AP 40 are suitable.

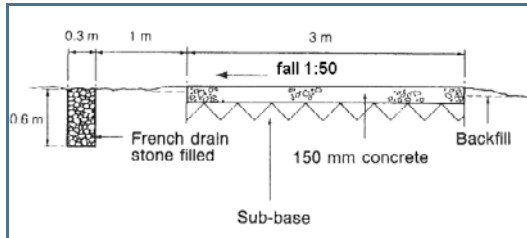

**Figure 3:** A section showing typical fall and drainage provision of a farm road

The thickness of fill varies with the end use of the slab, the relative levels of the concrete and its surroundings, and the type of sub-grade, e.g. at least 75 mm for floors and 75-150 mm for roads. Clay soils generally need a greater thickness. The maximum fill thickness is 600 mm and individual layers of fill should be compacted at no more than 150 mm thick. The top of the granular fill should be as smooth as possible. An uneven surface will restrict movement of a slab as it dries and shrinks, and this could lead to the concrete cracking.

## 4.2 Damp Proofing

Concrete will reduce water and water vapour ("damp") rising from the ground, but is less effective if the water table is high. Consequently, it is recommended that damp proofing be laid below all slabs that will house animals or used for storing dry materials.

Damp proofing will prevent moisture related problems in the structure, such as deterioration of timber base plates, floor coverings and other materials in contact with the concrete, and problems associated with high relative humidity within the building.

A damp proofing membrane generally consists of a layer of polythene sheet at least 0.25 mm thick.

Damp proofing must be properly installed to be effective. This includes:

- Laying on granular fill to prevent water being drawn into the slab by capillary action should the plastic be damaged.
- Blinding the top of the granular fill with a sand layer 5 mm to 25 mm thick or a heavyweight building paper to prevent the plastic being punctured by sharp stones.

- Covering the entire area, with appropriate detailing at the edge of the slab to prevent groundwater migrating into its outer face.
- Taping all penetrations and laps to prevent the passage of moisture through them.
- Ensuring the membrane is free from wrinkles and holes.

## 4.3 Slab Thickness

The load a slab can carry is dependent on the adequacy of the sub-grade to support the loaded slab. The reinforcing steel does not increase the load capacity of the slab, it is only required for shrinkage control.

For slabs subjected to traffic, acidic attack or stock races, slab thickness should be 100 mm to 125 mm thick, for other slabs 100 mm thick will suffice.

Slabs/pavements taking vehicles 3 tonnes to 10 tonnes should be 125 mm to 150 mm thick.

For slabs to take heavy machinery or loaded trucks over 10 tonnes, design should be undertaken by a structural engineer with experience in the design of ground floor pavements.

## 4.4 Joints

Like most materials, concrete shrinks when it dries out. If the shrinkage is restrained, by the ground, for instance, the concrete will crack within weeks and continue for months after casting. Early age thermal movements, from a cold night after casting, for instance, may cause the concrete to crack overnight or within the first two or three days after casting.

Joints or saw cuts are used to control the position of shrinkage cracks by producing straight cuts at predetermined locations. In this way a large area of concrete such as a floor is divided into separate slabs (bordered by the slab edge and *free joints* with no reinforcement passing through them), which in turn are divided into bays (bordered by the slab edge and *tied joints* which will have reinforcement passing through them).

*Shrinkage control joints* are used to divide a slab into bays to induce cracks in a particular position when the concrete shrinks. CCANZ recommends a maximum bay dimension of 5 m and the reinforcement must be continuous across the joint.

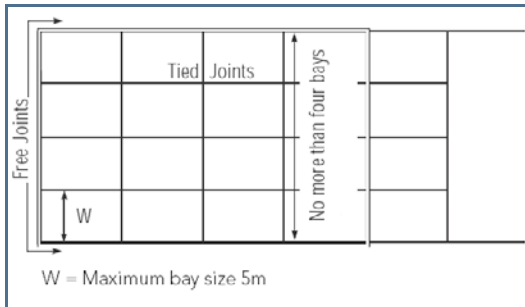

Figure 4: Joint spacing

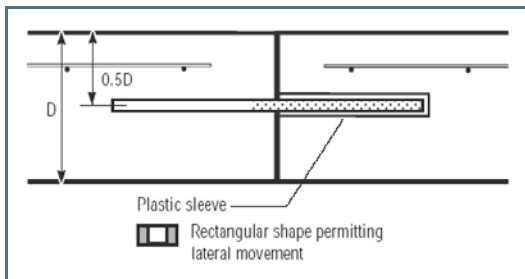

Figure 5: Free joint

Free joints are designed to take up movement in slabs with largest dimension 20 m (4 bays) for mesh reinforced concrete.

Free joints must not have their faces bonded and either:

- Have the reinforcement terminating each side of the joint; or
- Have dowel bars passing through the joint which are de-bonded on one side. Dowels are generally required where load transfer is required across a free joint. They are not recommended for slabs below 150 mm thick (Figure 5).

Joints should be positioned to coincide with major changes in plan such as internal corners, including re-entrant corners on box-outs and penetrations. Slab bays should preferably be square as they are less likely to crack. For structures covered by the New Zealand Building Act, the maximum length to width ratio needs to be less than 1.3:1. For other slabs CCANZ recommends a maximum of 1.5:1 length:width.

The other type of joint is an *isolation joint* where a fixture such as an internal column needs to be isolated so that the slab can move independently without restraint from the column. This is achieved

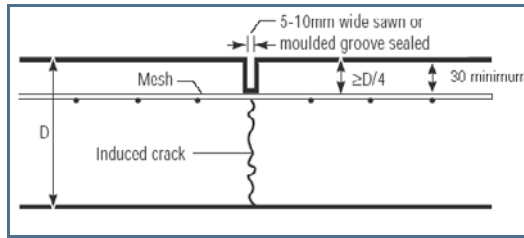

Figure 6: Tied joints

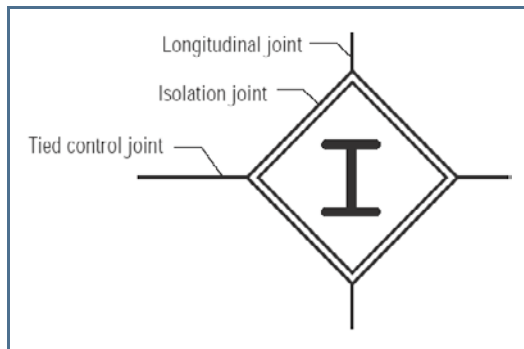

Figure 7: Isolation joint

by using compressible material such as polystyrene circumventing the column.

Maximum joint spacings recommendations are outlined further in NZS 3604, and BRANZ and CCANZ guidelines. Reinforcing can be omitted for slabs which don't come under the New Zealand Building Code. However, the joint spacing needs to reduce to 3 m centres. There is also a risk that successive joints will open up from shrinkage unevenly.

If the surface is to be covered with tiles or sheet materials special attention needs to be paid to ensure that the joints coincide with joints in the floor covering.

Where the surface will be exposed to wet service conditions joints must be sealed to prevent the ingress of water and dissolved chemicals. Proprietary systems are available for this purpose.

Section 7.6 describes how sawcut joints are created.

A construction joint (Figure 8) is used to accommodate an unplanned break in concrete placement. The joint should be formed to allow adequate compaction and finishing of the concrete along the edge. Once the concrete has hardened, the formwork is removed, the edge roughened to provide aggregate interlock across the joint and the new concrete placed against the existing edge.

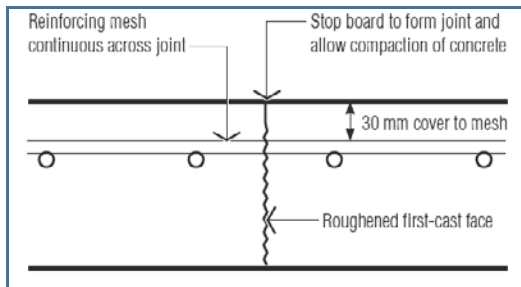

Figure 8: Construction joint

## 4.5 Reinforcement

Steel reinforcement controls the width of shrinkage cracks, allowing free movement joints to be spaced further apart and giving more choice in where they are placed. Reinforcement dowels prevent differential settlement between slabs across a free movement joint.

Reinforcement provides robustness to a slab by holding the slab together in the event of an accidental overloading the slab. Also welding steel mesh reinforcement to a dairy installation can help reduce stray voltages.

NZS 3604 for timber-framed buildings requires that residential concrete ground floor slabs must be reinforced with reinforcing steel or welded wire mesh at 2.27 kg/m<sup>2</sup> to Ductility Class E to AS/NZS 4671:2001 for slabs 100 mm thick.

CCANZ recommends that Ductile mesh is used for all ground floor slabs supporting a structure on the farm. 150 mm thick slabs would require proportionally heavier mesh – 3.40 kg/m<sup>2</sup>. Mesh codes vary with manufacturer but ductile mesh is referred to as Grade 500E. Mesh must be tied into the perimeter footing reinforcement.

For 100 mm thick slabs outdoors, 665 hard drawn wire mesh is suitable, with 663 mesh suitable for 150 mm thick slabs.

Steel mesh and bars must always be laid on reinforcement chairs at the recommended height and spacing. The chairs must not puncture the damp proof membrane if one is present. For effective shrinkage control the reinforcement must be in the top third of the slab but with a minimum 30 mm cover. Mesh should be fixed in position using purpose made supports spaced at maximum 800 mm centres. Mesh is available based on a 300 mm square grid to allow placers to walk between the mesh rods rather than on the mesh itself. Trucks should not be allowed to run over the mesh.

Minimum depth of cover between the reinforcement and the outer concrete surface should be at least 30 mm for structures that will not be exposed to chemical attack. For structures that will be exposed to aggressive chemicals in service the minimum cover depth should be at least 50 mm.

## 5.0 GETTING READY TO BUILD

Good planning is vital for successful concreting. Once mixed or delivered, concrete will set at the same rate whether or not you are ready for it.

The job should be divided into sections that can be conveniently placed and finished with the labour, equipment and time available.

### 5.1 Stay Within the Law

As with other commercial operations, farm construction is subject to the Health and Safety in Employment Act (1992), the Resource Management Act (1991), the Building Act (2004) and the Hazardous Substances and New Organisms Act (1996). The advice in this IB is intended to comply with the Building Act (2004). It assumes that the owner and contractor are both familiar with and have fulfilled their obligations under these and other regulations as required.

### 5.2 Watch for Services, Traffic, etc.

Locate buried services such as cables, drains and pipes before digging. Take the necessary precautions to avoid concrete pumps or other equipment coming in contact with power lines.

Arrange appropriate traffic management if working on a public road. Keep stock and vehicle traffic away from the job site.

## 6.0 PLANNING FOR CONCRETING

The first step is to work out the approximate amount of concrete needed in cubic metres. For example, the volume of a slab 10 m long, 5 m wide and 100 mm thick is:

$$10 \text{ m} \times 5 \text{ m} \times 0.1 \text{ m} = 5 \text{ cubic metres.}$$

The second step is to decide whether to buy ready mixed concrete or make it on site.

## 6.1 Pre-bagged Concrete versus DIY versus Ready Mix

Don't try to cast more concrete than can be mixed, placed and finished with time, equipment and people available!

**Pre-bagged concrete** generally comes in 25 kg or 40 kg bags. The 25 kg bag is ideal for mixing in a wheelbarrow. They are more expensive per unit volume of concrete than site batching or ready mixed concrete so are most suitable for small jobs where it would not be practical to buy, store and mix separate materials, or where it would be difficult to get the fresh concrete from a mixer to where it is needed.

The rapid set concretes offer the advantage that subsequent stages of construction, e.g. erecting a fence, need only wait a few hours or a day rather than a week for the concrete to gain strength.

**Site-mixed concrete.** The typical 100 litre rotating drum concrete mixer found on many sites makes up to about 50 litres (0.05 m<sup>3</sup>) per batch, about one wheelbarrow load. It will therefore take 20 individual mixes to mix one cubic metre of concrete. No more than 2 m<sup>3</sup> per day should be attempted using this type of mixer.

If concrete for a structure covered by the New Zealand Building Act is mixed on site it must meet the NZS 3104 requirements for prescribed mix concrete, which covers materials, mix design and batching and mixing. The maximum concrete strength under the Building Act for site mixing is 25 MPa.

**Ready mixed concrete** is cheaper and more convenient for larger volumes, providing enough people are available to place, compact and finish the concrete. A typical ready mix truck delivers 6 m<sup>3</sup> of concrete. Each cubic metre is 20-30 barrow loads, which can take significant time and effort to deliver into the formwork if the concrete cannot be placed directly from the truck.

Concrete needs to be placed within two to three hours from the time it is mixed and depending on the temperature will need to be finished within 2-5 hours after placing. A retarding admixture can be added if required to extend the time for placing. Some suppliers operate smaller trucks when smaller amounts are required. The minimum load should be 2 m<sup>3</sup> however, as accuracy of measurement effects small loads more than full loads. It may be also possible to order a part load depending on other orders the supplier has on a given day.

Ready mixed concrete is recommended for concrete that will be exposed to aggressive chemical conditions in service because it can be mixed with admixtures, blended cement or an SCM to improve durability.

Ready mixed concrete for structures built under the Building Act is to be supplied from a ready mix plant with a current quality certificate of audit issued by an Auditing engineer. The New Zealand Ready Mixed Concrete Association operates such an auditing scheme covering most concrete plants in New Zealand. The audit scheme provides assurance that the concrete is produced in accordance with NZS 3104 for the strengths specified for a project. The status of a ready mix plant can be checked at [www.rmcpplantaudit.org.nz](http://www.rmcpplantaudit.org.nz).

Concrete from a plant that does not belong to the scheme must meet the NZS 3104 requirements for prescribed mix concrete (Section 3), with maximum strength 25 MPa.

## 6.2 Can a Ready Mix Truck Get to the Site?

If ready mixed concrete is to be used the site must be accessible by the ready mix truck. A typical ready mix truck is about 2.5 m wide, 8 m long, has a turning circle of 16 m and weighs 20 tonnes when full. The chute will reach about 3 m.

For a new facility the access roads should therefore be built first. To place a large slab, access is needed to several positions around its perimeter otherwise a pump, crane-skip or other means of moving the concrete (e.g. front end loader, bobcat, or wheelbarrow) may be needed. Suitable access for this equipment must also be provided.

## 6.3 How Many People Will You Need?

Two people are needed for site casting 2 m<sup>3</sup>. With proper planning a large area can be placed over several days by two people mixing on site.

If using ready-mixed concrete, then more formwork, handling equipment (vibrators etc.) and man-power will be required. Many truckloads can be placed in one day by a larger team using ready mixed concrete.

So the establishment cost for a large pour has to be balanced against the longer time for site mixed concrete.

## 6.4 Listen to the Weather Forecast and Take Appropriate Precautions

Cool, overcast weather is ideal for concreting but it's not always possible to wait for the perfect day. Weather conditions during placement can ruin the quality of a concrete slab if appropriate precautions aren't taken.

Don't concrete outside if rain is forecast. Rain will damage the surface of the concrete. It will also increase the amount of water in stockpiled aggregates and the amount of water added to the mix will have to be adjusted accordingly.

Don't concrete on frozen ground or when frosty conditions are forecast. The cold temperature will delay setting. Water freezing in the fresh concrete will damage the structure of the hydrated cement binder, permanently weakening the concrete and reducing its durability.

When concreting in cold weather, cover the aggregates at night to prevent them chilling or freezing, and mix with warm water if possible. Once the exposed surface has been finished, insulate it with a fibre material between two sheets of polythene, or a layer of other insulating material so that the heat generated as the cement binder hydrates keeps the concrete warm enough to set and harden.

Also, if there is a large temperature swing from the hot day to the cool night, insulation prevents the exposed surface cracking as it cools and shrinks relative to the interior concrete. In cold weather the concrete will take longer to gain strength and the construction schedule should allow for this. Ready mixed concrete suppliers can add an accelerating admixture to the concrete to increase the rate of strength gain if necessary.

In hot weather, concrete will set quickly and if too much is placed at once there may not be enough time to finish it properly. Time the mixing of individual batches or truck deliveries to allow for this. Ready mixed concrete suppliers can add a retarding admixture to the concrete to delay setting in hot weather if asked. This may ultimately result in a stronger concrete.

On warm or windy days special care is needed to protect exposed fresh concrete surfaces from sun and wind, especially before curing begins. If it's a good day for drying the washing then freshly placed concrete is more likely to dry prematurely and crack. Refer to Section 7.4.

## 6.5 Ordering Materials

### 6.5.1 Ready Mixed Concrete

Specifications for suitable ready mixed concretes are given in **Table 1**. Specify only the strength and slump required, not the mix design itself. The concrete supplier is responsible for the mix design.

The New Zealand Standard for concrete production, NZS 3104, defines two types of concrete, "Normal" and "Special". These designations refer to the means by which it is determined that the concrete meets the project specification, not to the quality of the concrete. Concrete specified by strength and slump only is "Normal". If one or more properties in addition to strength and slump are specified the concrete becomes "Special". Concrete for corrosive conditions on the farm may be considered Special concrete. The means by which Special concrete is assessed to meet the purchaser's requirements should be discussed with the supplier when ordering the concrete.

The contractor will need to supply the following information when concrete is ordered:

#### Mandatory Requirements:

- Specified Compressive Strength required (in MPa).
- Nominal maximum aggregate size.
- How workable you need the concrete (measured in millimetres of slump).
- How the concrete is to be placed.
- Any additional requirements associated with Special Concrete.

#### Optional Requirements:

- When the concrete is to be delivered and the interval between deliveries if more than one truckload is needed.
- Where to deliver the concrete to.
- How much concrete you need (allow about 10% for waste).
- Ease of access to the point of placement (can more than one truck get to the site at the same time).
- Anything else about the project or site that would help the supplier to provide the right material at the right time, for example the size of the job and the conditions the concrete will be exposed to in service.

Ready mixed concrete suppliers will be happy to discuss your requirements, particularly if you need concrete that will be exposed to abrasive or corrosive acid conditions. Order the concrete several days in advance to ensure it can be delivered on the day it's needed. If the order needs to be cancelled or delayed do this as early as possible.

In general, the slump recommended should be 100 mm if using hand held mechanical screed vibrators. For hand screeding without mechanical vibration, the slump should be higher at 120-130 mm. For bedding concrete (Mix E), the slump will be a lot lower at 50 mm. Recommended slumps are given in **Tables 1 and 2** in the Appendices.

### 6.5.2 Site Mixed Concrete

For site mixing, either pre-bagged concrete, or cement, sand and aggregates, or cement and builders' mix need to be ordered.

The grading and shape of coarse aggregate and sand will vary from location to location. Consequently the mix proportions in **Tables 1 and 2** may require adjustment by a mix designer to suit local materials. NZS 3104 gives grading requirements for builders' mix. If the grading is outside this requirement the concrete supplied will not meet the requirements of The Building Act.

Sand "bulks", i.e. takes up more volume when damp, and the tables allow for this.

Allow for some wastage of aggregates, about 10%. Less cement is likely to be wasted, but allow for at least two extra bags in case a bag is damaged or part of a bag is needed to complete a pour. For example, for mixing 5 cubic metres of 30 MPa concrete you need the following:

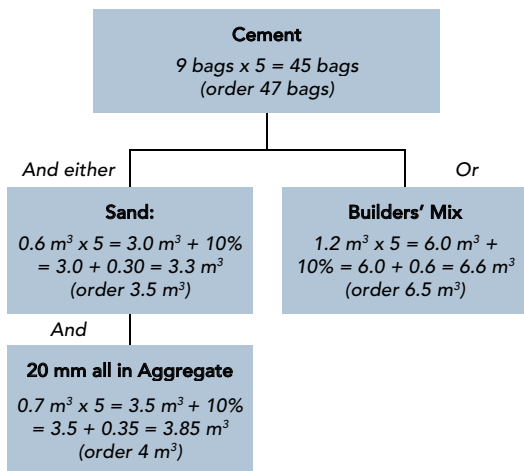

For proprietary pre-bagged concrete, the bag and instructions will indicate the approximate yield per bag. Allow for at least one extra bag in case a bag is damaged. Use the same product for the whole job.

## 6.6 Storing Materials

### 6.6.1 Aggregate

Once on site, each type of aggregate must be stockpiled separately on a hard, well-drained surface.

Stockpiles of aggregate must be protected to prevent animals contaminating the materials with urine and faeces, children introducing foreign materials, seeds and other organic matter blowing onto the pile, rain washing fine material to the bottom of the pile and sea spray or marine winds depositing salt on the aggregate. This can be done by covering the pile with a plastic sheet that is weighted down so it can't blow away, and by fencing the pile to keep stock away.

Kept clean this way, aggregate can be stored indefinitely so if space is available it may be convenient to buy enough for future small jobs.

### 6.6.2 Cement and Pre-bagged Concrete

Bags must be protected from moisture or the cement will partly set in the bag. Store them on a hard, dry surface, under cover if possible. If stored outside, keep them on planks or pallets raised off the ground and securely covered with plastic. Don't order more than is needed for the job in hand because moisture in the air will eventually penetrate the bags and the cement in the bag will partly harden. Initially this "air hardening" forms small lumps in the cement that can't be crushed between the fingers, but the entire bag can go hard if it gets wet enough. Buy fresh bags rather than using cement that has gone off in the bag - the worst that can happen is that you have to buy a different brand and the concrete made from the new cement will be a slightly different colour.

## 6.7 Site Mixed Concrete

Divide the job into sections that can be completed within a convenient time. For floor slabs, remember to allow time for finishing. Only 2 m<sup>3</sup> should be attempted in one working day, particularly for a floor slab.

The rules to remember are:

- Measure the amount of cement the same way for each batch of concrete.

- Measure the aggregates the same way for each batch of concrete.
- Don't add too much water.
- Add the constituents in the correct order and only add the final amount of water if necessary.
- Keep tools and equipment clean.
- Don't mix more than can be placed and finished within a convenient time.

### 6.7.1 Measuring Materials for Site Mixed Concrete

#### Cement:

For a 50 litre mix the cement quantities can be taken directly from **Table 2**.

It is preferable to pre-weigh the cement into heavy plastic bags and use one of these bags per batch. A less accurate but more common method is to weigh one batch of cement and place it in a clean, dry bucket. Use a clean, dry shovel for loading the cement into the bucket.

Knock the bucket on the ground to compact the cement, counting the number of times it's knocked and mark the level of cement on the bucket. For each subsequent batch fill and compact the bucket the same way so that the level of cement reaches the mark. Then tip the bucket into the mixer. Don't use the bucket for anything other than measuring cement.

#### Aggregate:

Accurate measurement of aggregates is also important. Initially the volumes should be measured by shovelling into clean containers of known volume, e.g. buckets. A typical household bucket is 9 litres, and this is the basis for the quantities in **Table 2**. Paint and chemicals are supplied in buckets of many different volumes – if such buckets are used work out their volumes by filling them with water and weighing the filled bucket. Measure out the volume in litres from **Table 2**.

Once experience is gained with the number of shovelfuls of each aggregate needed to fill the buckets to the required level, then the aggregates may be shovelled directly into the mixer. This method is less accurate and it is recommended that the bucket method be used when restarting after a break until the rhythm of batching is regained and the concrete seen to be satisfactory. The shovel used must be clean, with no concrete or cement adhering to it.

#### Water:

The total water in the concrete comes from the moisture in the aggregate and the water added at the mixer.

SSD means "saturated and surface dry". It is defined as the moisture condition when the aggregate particles have absorbed all the water they can without excess water appearing on the surface. They will neither absorb water from the mix nor contribute free water to it. At SSD the aggregate looks dry.

The water quantities given in **Table 2** cover the typical range of aggregate moisture conditions – SSD, damp, wet. The key is not to add too much water.

For both site-batched concrete and pre-bagged concrete the water should be measured accurately in a clean, graduated bucket that has been pre-wetted and drained.

When mixing in a drum mixer:

- Place about  $\frac{3}{4}$  of the water in the mixer.
- Place about  $\frac{3}{4}$  of the measured aggregate in the mixer.
- Turn the mixer on.
- Place all the measured cement in the mixer.
- Place remaining  $\frac{1}{4}$  of aggregate in the mixer.

Once all materials have been added mix for 2-3 minutes. If at the end of this time the mix looks too dry slowly add the remaining water while continuing to mix. Stop adding water as soon as the mix looks uniform in appearance and sufficiently workable. It should fall cleanly off the mixer blades without being over-wet and there should be no dry cement or sand stuck to the corners of the mixer bowl.

Test the concrete for workability by trowelling the concrete in the mixer with the back of a clean shovel or a steel trowel. Concrete will be approximately the right workability when the trowelled concrete surface is closed and moist but not showing an excess of cement and water ("fat").

If there's a delay before starting the next batch, put part of the aggregate and water in the mixer and let it turn over while waiting.

Small quantities may be mixed in a barrow or on a clean, hard surface on the ground. Measure out the sand and gravel into a heap, then make a well in the

centre of the heap and add the cement. Turn the heap thoroughly until it is a uniform appearance. Make a well in the centre and add some of the water. Mix by turning the dry material from the edge of the heap into the centre. Continue to mix and add water until the concrete is well mixed and the right workability.

For pre-bagged products follow the manufacturer's instructions. Do not add anything except water. Mix thoroughly because the contents of the bag may have segregated during handling and storage. Rapid set products should only be mixed one bag at a time. Do not mix different brands or types of bagged product together because the additives in each product may not be compatible.

If there's a delay in placing a batch and it stiffens in the mixer or barrow extra water may be added within an hour of the original water addition. Do not add more than 0.5 litres of water for each mixer load to rejuvenate it or the final strength will be reduced. Remix the concrete thoroughly before placing. Discard the mix if excess water is required.

Keep tools and equipment clean. Wash and scrub them thoroughly before the concrete hardens. Hardened material can be removed from metal by wire brushing. After the last mix of the day put some aggregate and water in the mixer and let it run for several minutes – this will make it easier to clean. If hardened material collects in the drum or on the blades the mixer will gradually become less effective.

## 7.0 PLACING CONCRETE

The concretes recommended in **Table 1** should be sufficiently workable to be easy to place and finish.

If the slump of **ready mixed concrete** is less than specified when delivered and the concrete is less than one hour old the supplier may add up to 10 litres of water per cubic metre of concrete. This allows for the fact that the concrete may have dried up in transit. NZS 3104 specifies the conditions under which the water may be added.

### 7.1 Transporting Fresh Concrete

Ready mixed concrete may be discharged directly from the truck to the point of placing if the truck can be positioned so that its extended chute discharges into the correct location. Alternatively the concrete may be pumped from the truck into the formwork.

If the concrete is to be pumped, this should be advised when ordering the concrete as a different mix design is required to ensure that the concrete

can be pumped.

Avoid jolting or jarring when transporting fresh concrete by wheelbarrow. Planks or other types of pathway may need to be set up to provide a smooth running surface. Deposit the barrow load in the approximate position where it is needed.

### 7.2 Placing

However it is discharged, the concrete will need to be spread into place. Spread the concrete with a shovel or rake so that it forms a slight surcharge over the shutter edges (**Figure 9**).

Do not use a vibrator to spread the concrete.

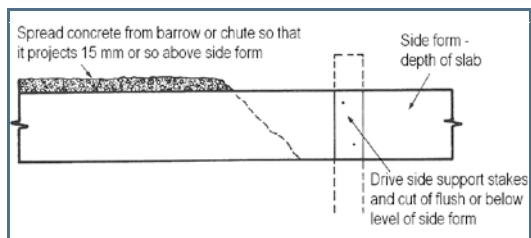

**Figure 9:** Placing Concrete

### 7.3 Compacting

Once in place the concrete must be compacted to remove large air voids which would otherwise weaken it. Pumped concrete must be compacted too, even though it may appear to be well consolidated when placed because of its high workability.

For paths and storage areas, 100 mm thick or less, that are not subjected to corrosive attack, compact the concrete by hand tamping with a heavy screed board as shown in **Figure 10**.

Work the concrete well into the corners with a timber tamping rod. When the concrete is compacted, screed the surface to remove the surplus. With a small surcharge of concrete in front of the screed, move it slowly across the surface with a sawing action, applying enough pressure to hold each end firmly against the edges of the formwork or screed rails.

Vertical structures or concrete floors that will be exposed to corrosive substances or significant abrasion must be compacted with a mechanical vibrator. A vibrating screed is best for floor slabs (see **Figure 11**) but an immersion poker vibrator is required around the perimeter of the screeded area. **Figure 12** shows how to use a poker vibrator correctly.





Figure 10: Hand tamping



Figure 11: Lightweight vibrating screed



Figure 12: Immersion poker vibration



Figure 13: Ball floating

## 7.4 Finishing Floors

Floor slabs are finished in three stages.

### Stage 1: Smooth the Surface with a Float

Once the concrete has been screeded to the correct level the screed marks should be removed immediately if this finish is too rough for the final use. This is done by several passes with a ball float (an aluminium or magnesium float on a long handle) until the concrete is smooth. For small areas, a wooden or magnesium hand float worked into over the surface will suffice.

For large areas or stiff mixes, power floating can be done with flat wide float blades or with a Kelly float which is a disc type machine.

Do not overwork the surface at this stage.

### Stage 2: Leave the Concrete to Bleed

After this initial floating, water from the concrete (known as “bleed water”) will appear on the surface. **No** subsequent finishing operations should take place until this water has evaporated. Do not spread cement on the surface to mop up the moisture or squeegee the water from the slab. Both these practices will result in a weaker surface.

During this stage the exposed surface must be protected from excessive drying, especially on warm or windy days, with low humidity. If the surface dries so fast that bleed water on the surface evaporates faster than it is replaced, the surface will shrink and crack. This type of cracking is known as “plastic shrinkage cracking”. It may be possible to rework the concrete to close plastic cracks when they first appear, but if not completely closed below the surface, they may reappear when the concrete dries during the first few weeks after casting. In areas where durability or appearance isn’t important, dry cement may be brushed into the cracks before curing starts.

Concretes made from Type GB cement or containing SCM do not bleed as much as concrete made from Type GP cement, so are more prone to plastic shrinkage cracking. These types of concrete are typically used for floor slabs that will be exposed to corrosive conditions. Particular care must be taken to prevent these concretes from drying between Stage 1 and Stage 3 because plastic shrinkage cracking will reduce their acid resistance.

Polypropylene fibre may be added to the concrete mix as a mitigation measure to prevent plastic cracks forming. The fibres operate effectively only when the

concrete is in the plastic state by intercepting bleeding channels which may become plastic cracks if the concrete is allowed to dry out.

Note that polypropylene fibres are weak in tension and are no substitute for reinforcing mesh to prevent concrete shrinkage cracking.

Plastic shrinkage cracking can be prevented by protecting the exposed concrete surface from sun and wind before the final trowelling. This is most easily achieved by spraying a proprietary anti-evaporation coating, 'anti-vap', onto the surface immediately after Stage 1 finishing. A water mist can also be effective. These will need to be reapplied during the period between floating and final trowelling to keep the surface from drying out.

### Stage 3: Densify the Surface by Trowelling

The final surface finish can be applied when the bleed water has evaporated and the surface is hard enough that an average weight man standing on it leaves footprints no more than 2-3 m deep.

Concretes made from Type GB cement or containing SCM may stop bleeding before they are ready to be trowelled so a lack of bleed water on the surface is not sufficient indication that they are ready for the final trowelling.

**Do not** add water to the surface to make it easier to finish – this will produce a weaker surface.

For paths and storage areas etc, the surface can be finished with a sweeping action of a wooden float or by drawing a yard broom across the surface. For areas to be used by stock, a tamped or grooved finish is preferred because it is less abrasive to their feet than a broomed finish (**Figure 14**).

A grooved finish can be produced with a grooving tool as shown in **Figure 15**. The spacing and depths of the grooves can be modified to suite a particular application. Round off the edges of the slab with an arising tool.

Concrete that will be exposed to corrosive attack must be worked with a steel trowel (by hand or machine) into a hard dense surface. In the case of power trowelling, the blades are progressively tilted to densify the surface. The trowelling can be repeated at intervals to further increase the hardness and durability of the surface. This operation requires some skill to correctly judge the timing or repeated applications of trowelling (**Figure 16**). If trowelling commences too early whilst the concrete is still bleeding, delamination can occur where a hard top 'skin' to the slab traps a pocket of

bleed water below which leads to delamination of the top surface.



**Figure 14:** Grooving dairy yard



**Figure 15:** Grooving tool



**Figure 16:** Power floating

Steel trowelling produces a smooth and very slippery surface that may not be acceptable in areas trafficked by people or animals. A compromise may be reached by finishing the surface with a wood float immediately after the first steel trowelling instead of carrying out the second steel trowelling. Proprietary

materials may also be sprinkled on the finished surface to improve slip resistance. Treatments applied to improve slip resistance may trap dirt and make the surface harder to keep clean if they roughen the surface too much, so they must be selected and applied carefully.

## 7.5 Curing

For concrete to achieve optimum strength and durability it must be cured to prevent loss of moisture. Curing must start as soon as possible after the final stage of finishing, immediately the concrete has hardened enough not to be marked.

Options for curing are:

- Water cure: keep the entire surface of the concrete continuously wet by ponding, mist spray or sprinkler.
- Polythene cure: wet the surface then cover with polythene, keeping all edges of the polythene tightly secured and sealed to the outside of the formwork to prevent moisture loss.
- Curing compound: apply a proprietary curing compound according to manufacturer's specifications. Membrane forming curing compounds are as efficient as wet curing and are required to meet AS 3799 or ASTM C309. NZS 3109 Clause 7.8.2 gives more details.

Concrete for paths, storage sheds, etc. may be cured by water, polythene or curing compound. The minimum curing period for water or polythene cure is three days. Slabs requiring abrasion resistance, chemical resistance or located in the coastal zone require a minimum 7 days curing. Curing compounds do not need to be removed. They should not be used on surfaces that are to receive protective or decorative coatings or coverings.

**Figure 17:** Curing concrete using a sprinkler

Concrete that will be exposed to corrosive attack must be cured by water for at least seven days. Sand embankments around the edge of a slab can be used to pond the water, but the water level must be topped up each day.

## 7.6 Cutting Joints

Joints should be in place before the first night to avoid cracks from overnight temperature swings. Joints can be cut with a saw as soon as the concrete is hard enough. All cutting should be done within 24 hours after placement. Early entry or "soft cut" saws will allow the slab to be cut within the first few hours, which reduces any risk of early cracking in hot or windy conditions.

Traditional saw cutting equipment will allow the joint to be cut within 12 to 18 hours after cutting. For shrinkage control joints cut the slab to about one third its depth but not less than 30 mm. For free joints, cut the slab to at least half its depth to ensure all reinforcing steel is cut.

Alternatively joints may be created by making an impression in the surface of the fresh concrete with a jointing tool or steel t-section as soon as the surface is finished (**Figure 18**), or by using a proprietary crack inducer (**Figure 19**).



**Figure 18:** Jointing tool or T section

## 7.7 Commissioning the Structure

Concrete can be exposed to foot traffic and light loads after curing (3 to 7 days depending on the structure).

Slabs exposed to wheel loads should not be subjected to private vehicles for at least 7 days or to heavy traffic for 14 days.

Stock and aggressive chemicals should be kept away from new concrete for at least 28 days.

The structure can be put into use earlier if the concrete is made with rapid hardening cement or accelerating admixtures. These may reduce the commissioning time by up to half depending on the weather.

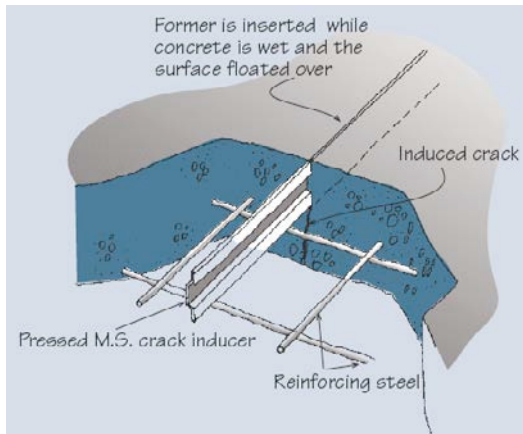

**Figure 19:** Crack inducer (for reinforced or unreinforced slabs)

- retain and dry it, then bury the residue as clean fill.
- Crush it once hardened for recycling as concrete aggregate.
- pump to sewer (with permission of the local authority).
- hire a waste management contractor to remove and dispose of it.

Most ready mix plants can return leftover concrete to the plant for disposal. Bunds may be needed to retain the contaminated water and prevent it entering drains and waterways. The water can then be pumped, vacuumed or bailed out for disposal.

Minimising the amount of water used for cleaning will reduce the disposal problem.

More detailed information is provided in “Site Management of Concrete Washwater” published by the New Zealand Ready Mixed Concrete Association.

### 7.8 Disposal of Waste

Waste water from washing out concrete mixers, trucks and other equipment is highly toxic to fish and other aquatic wildlife so should not be discharged into natural waterways or reticulation systems that drain into them. Any person or organisation found discharging contaminated water into waterways is in breach of the Resource Management Act (1991) and liable for an infringement fee if caught. A watercourse full of lifeless fish and invertebrates downstream from a recent concreting job is a dead giveaway!

Stormwater systems do not provide adequate treatment for concrete waste water. Diluting the waste water isn't a practical solution because large volumes of water are needed to dilute it enough to discharge safely. Insufficient dilution will make the problem worse because of the larger volume of waste water involved. Filtering the water is also ineffective because it will only remove solid contaminants, not those dissolved in the water.

Some Regional Councils now have guidelines for the disposal of waste water from concreting operations. These include (in order of decreasing preference):

- returning wash water from ready mix trucks to the concrete plant for recycling.
- putting it into soil where it won't drain into a waterway or stormwater system.

### 7.9 Personal Safety

Concrete and the materials used to make it, tend to be heavy. Make sure stored materials, equipment, and freshly cast structures are secure and stable – prop them if necessary – and take appropriate precautions to prevent back injuries when lifting and handling.

Cement and other powdered components of concrete present a dust hazard so when opening and emptying bags of cement or cement products wear a disposable dust mask, preferably one suitable for fine silica materials (readily available from safety equipment suppliers).

Fresh concrete, mortar and plaster are highly alkaline and can cause severe chemical burns to skin and eyes. In addition, the alkalis can sensitise exposed skin so that allergens in the cement, such as chromium, can penetrate more easily.

When working with fresh concrete, mortar and plaster always wear waterproof gloves and footwear, a long sleeved shirt and long trousers, and proper eye protection. Wash wet concrete, mortar, cement, or cement mixtures from your skin immediately. Flush eyes with clean water immediately after contact. Indirect contact through clothing can be every bit as serious as direct contact, so promptly remove and thoroughly rinse any clothing contaminated with wet concrete, mortar, cement or cement mixtures.

Seek immediate medical attention if you have persistent or severe discomfort after coming into direct contact with fresh concrete.

Cement and lime powder can damage metal and painted surfaces so wash cement and lime dust off machinery, vehicles and other equipment as soon as possible.

## 8.0 HOW TO CHOOSE AND SUPERVISE A CONTRACTOR

Often it is more cost effective to hire a builder or contractor to mix and place the concrete. Some contractors may consider that their responsibility ends once the concrete is placed – after all, all concrete looks the same! So you need to take a few precautions to ensure the job is done properly.

When selecting a contractor:

- Ask for references from similar jobs to yours, ask the owners whether they were satisfied with the job, find out the nature of any problems encountered with the work or the contract and visit the site if possible.
- Give the contractor a copy of the construction drawings and a plan of the site.
- Ask the contractor how he will determine whether the existing ground is sound enough to support the structure and any other load, or how he will improve its strength if necessary.
- Get a written quote from the contractor detailing all items in the contract, including finishing, curing and cutting joints.
- Deal only with the main contractor to avoid delays and arguments. If sub-contractors are used for any part of the work they should be hired and directed by the main contractor.

Ask the contractor to employ a concrete placer who is member of the New Zealand Master Concrete Placers Association ([www.mcpa.org.nz](http://www.mcpa.org.nz)). This will provide some assurance that the concrete work will be done to comply with NZS 3109.

When the work is in progress look out for the following:

- Concrete should not be placed if rain or frost is forecast. Slabs should not be placed on hot or windy days.

- The area to be concreted should be smooth and well compacted before reinforcing steel is placed, with no soft or muddy areas.
- Formwork should be where shown in the plans and should be securely fixed so that it doesn't move when filled with concrete.
- Screed rails should be fixed at the right levels.
- Damp proof membranes should be placed over a bed of compacted sand to protect them from being punctured by stones, cover the entire area, be free from holes and wrinkles and be properly secured at the edges.
- If the concrete is to be placed directly on dry ground the contractor should spray the ground surface with water before casting concrete.
- Reinforcing steel should be spaced off the ground and formwork, and well secured against accidental movement. Crack inducers and starter bars for adjacent elements should be fastened in place.
- Drains, sewers, cables and pipes need to be located and protected from damage.
- Ready mixed concrete should be the strength and slump that was ordered.
- Water must not be added to ready mixed concrete without the consent of the supplier.
- If concrete is mixed on site, know how much cement is needed, make sure the right number of bags of cement arrive on site and no full ones are taken away.

All materials must be correctly and consistently measured from batch to batch. No more than 10 litres of water /m<sup>3</sup> may be added to the mixer to rejuvenate a mix that has started to go off if there's been a delay that prevents it being placed in time. The water must be added within an hour of mixing.

- The concrete must be compacted with a poker vibrator or mechanical vibrating screed.
- The surface finish chosen for a slab must not be applied until all water has evaporated from the concrete surface. Cement must not be sprinkled on the surface to "mop up" water or water squeegeed off the surface so the slab can be finished sooner, and water should not be added to the surface to make it easier to finish.
- While the surface of a slab is waiting to be finished it should be protected from drying out

with a mist spray or an anti-evaporation compound sprayed on the concrete surface.

- Concrete cast outside should be covered if possible for the first few days to protect it from extreme temperature variations that can lead to cracking.
- Control joints and free joints should be cut in slabs at the positions shown on the drawings. They should be cut within 24 hours from casting, and within 12 hours in hot weather.
- The concrete should be cured for 3 to 7 days depending on the use of the concrete.
- Light traffic should be kept off a concrete slab for 7 days after casting. Stock, vehicles and heavy equipment should be kept away for 28 days.

## 9.0 REFERENCES

### 9.1 General

More about the topics presented in this Information Bulletin can be found on the CCANZ website ([www.ccanz.org.nz](http://www.ccanz.org.nz)) and in publications published by CCANZ, BRANZ and suppliers of concrete and concrete materials. The following are of general interest:

- BRANZ (1998). *Good concrete floors and basements practice*. Good Practice Guide BK 006.
- BRANZ (2005). *Concrete slabs and control joints*. Build August/September 2005, pp22-25.
- CCANZ (2011). *Residential concrete: Slab-on-ground floors*. MS 17.
- CCANZ (2004). *Concrete at home*. Information Bulletin IB 57.
- New Zealand Ready Mixed Concrete Association (2006). *On-site management of concrete washwater*.

- New Zealand Ready Mixed Concrete Association (2005). *Farm concrete guidelines*.

### 9.2 Standards

Concrete materials, design and construction are covered by a series of standards published by Standards New Zealand that will be referred to in plans and specifications. Concrete structures covered by the Building Act must be built to these standards. These standards are:

- NZS 3101:2006 *Concrete Structures Standard*
- NZS 3104:2003 *Specification for Concrete Production*
- NZS 3109:1997 *Concrete Construction*
- NZS 3111:1986 *Methods of Test for Water and Aggregate for Concrete*
- NZS 3121:2009 *Specification for Water and Aggregate for Concrete*
- NZS 3122:2011 *Specification for Portland and Blended Cements*
- NZS 3604:1999 *Timber framed Buildings*
- AS/NZS 4671-2001 *Steel Reinforcing Materials*
- Ministry of Health (2005). *Drinking-water Standards for New Zealand 2005*. Wellington: Ministry of Health. ISBN 0-478-28392-X (Book), ISBN 0-478-28395-4 (Internet), HP 4124.

### 9.3 CCANZ Publications

CCANZ technical publications may be found at [www.ccanz.org.nz/documents.aspx](http://www.ccanz.org.nz/documents.aspx).

### 9.4 NZRMCA Publications

NZRMCA technical publications may be found at [www.nzrmca.org.nz/publications.htm](http://www.nzrmca.org.nz/publications.htm).

ISSN 0114-8826

© Revised February 2013. Cement & Concrete Association of New Zealand, Level 6, 142 Featherston Street, PO Box 448, Wellington, telephone (04) 499-8820, fax (04) 499-7760, e-mail [admin@ccanz.org.nz](mailto:admin@ccanz.org.nz), [www.ccanz.org.nz](http://www.ccanz.org.nz).

Since the information in the bulletin is for general guidance only and in no way replaces the services of professional consultants on particular projects, no liability can be accepted by the Association by its use.

## APPENDIX A

Table 1: Concrete mixes for farm conditions – information for ordering

Mlx	Ready Mixed Specification	Use	Site Mixing Information						
			Proportions by volume <sup>1</sup>	Amount per cubic metre SSD <sup>2</sup>	Amount per cubic metre damp <sup>3</sup>	Amount per cubic metre wet <sup>4</sup>	Yield of concrete per cement bag	Bulk amount per cubic metre of concrete	
<b>A</b>	<b>30 MPa;</b> max agg size 20 mm; slump 100 mm	Wet corrosive <sup>5</sup> conditions (dairy floors, pig slats, silage/manure storage), not Building Act compliant <sup>6</sup>	Cement (sand (20 mm OR builders' mix water	1 2 2.5 4.5 0.50	360 kg 820 kg 1000 kg 1820 kg 180 L	360 kg 860 kg 1010 kg 1870 kg 130 L	360 kg 1910 kg 90 L	0.111 m <sup>3</sup>	9 bags 0.60 m <sup>3</sup> 0.70 m <sup>3</sup> 1.20 m <sup>3</sup>
<b>B</b>	<b>25 MPa;</b> max agg size 20 mm; slump 130 mm	Roadways, buildings, foundations Complies with the Building Act	Cement (sand (20 mm OR builders' mix water	1 2.25 2.5 4.75 0.55	340 kg 845 kg 990 kg 1835 kg 200 L	340 kg 885 kg 1000 kg 1885 kg 150 L	340 kg 1930 kg 100 L	0.120 m <sup>3</sup>	9 bags 0.65 m <sup>3</sup> 0.70 m <sup>3</sup> 1.20 m <sup>3</sup>
<b>C</b>	<b>17.5/20 MPa;</b> max agg size 20 mm; slump 130 mm	General purpose, Complies with the Building Act	Cement (sand (20 mm OR builders' mix water	1 2.5 3 5.5 0.60	300 kg 890 kg 985 kg 1860 kg 200 L	300 kg 930 kg 995 kg 1910 kg 150 L	300 kg 1960 kg 100 L	0.135 m <sup>3</sup>	8 bags 0.65 m <sup>3</sup> 0.70 m <sup>3</sup> 1.20 m <sup>3</sup>
<b>D</b>	<b>15 MPa;</b> max agg size 20 mm; slump 130 mm	General purpose, not Building Act compliant	Cement (sand (20 mm OR builders' mix water	1 3.25 3.5 6.75 0.80	240 kg 900 kg 975 kg 1875 kg 200 L	240 kg 950 kg 985 kg 1925 kg 150 L	240 kg 1975 kg 100 L	0.145 m <sup>3</sup>	6 bags 0.70 m <sup>3</sup> 0.70 m <sup>3</sup> 1.25 m <sup>3</sup>
<b>E</b>	<b>10 MPa Dry Mix;</b> max agg size 20 mm; slump 50 mm	Bedding concrete (fence posts etc.) not Building Act compliant	Cement (sand (20 mm OR builders' mix water	1 4.5 4.5 9 0.40	200 kg 1000 kg 1050 kg 2050 kg 160 L	200 kg 1050 kg 1060 kg 2110 kg 100 L	200 kg 2160 kg 50 L	0.200 m <sup>3</sup>	5 bags 0.70 m <sup>3</sup> 0.70 m <sup>3</sup> 1.25 m <sup>3</sup>

## Notes to Table 1:

- Materials are ordered and batched in bulk volume. Use sand/aggregate OR builders' mix. Mix designs using separate sand and aggregate must be approved by a professional engineer or authorised representative if the concrete is for a structure covered by the Building Act.

The quantities given for site mixing are a starting point only and may need fine tuning for local materials. More cement may be needed when the grading or shape of aggregates is poor.

- SSD means "saturated and surface dry". It is defined as the moisture condition when the aggregate particles have absorbed all the water they can without excess water appearing on the surface. They will neither absorb water from the mix nor contribute free water to it. At SSD the aggregate looks dry.
- Most aggregates are damp when delivered. In this condition the sand can be squeezed into shape in the hand. Damp conditions are assumed to be 5% moisture in sand, 1% in aggregate, 3% in builders' mix. Damp sand "bulks", i.e. takes up more volume than sand at SSD. 20% bulking of damp sand is assumed here.
- If the builders' mix is wet, water can be squeezed out.
- Concrete exposed to acids and other aggressive chemicals requires use of a type GB cement and/or an SCM.
- Unless supplied from a ready-mix concrete plant compliant with NZS 3104.

## APPENDIX B

**Table 2: Concrete mixes for farm conditions – quantities of materials for 50 litre capacity mixer**

Mix	Ready Mixed Specification	Use	Solids			Water		
			Volume proportions (measured in 9 litre buckets) <sup>1</sup>		Cement to builders' mix	Quantity (SSD)	Aggregate condition <sup>2</sup>	Volume of water to add <sup>3</sup>
<b>A</b>	<b>30 MPa;</b> max agg size 20 mm; slump 100 mm	Wet corrosive conditions (dairy floors, pig slats, silage/manure storage does not comply with the Building Act <sup>4</sup> )	Cement (sand (20 mm OR builders' mix	1.5 3.5 4.0 6.75	(1 to 4.5)	18 kg 30 L 35 L 65 L	Damp SSD Wet	6.5 litres 9 litres 4.5 litres
<b>B</b>	<b>25 MPa;</b> max agg size 20 mm; slump 130 mm	Roadways, buildings, foundations to comply with the Building Act	Cement (sand (20 mm OR builders' mix	1.5 3.75 4.25 7	(1 to 4.75)	17 kg 35 L 35 L 70 L	Damp SSD Wet	7.5 litres 10 litres 5 litres
<b>C</b>	<b>17.5/20 MPa;</b> max agg size 20 mm; slump 130 mm	General purpose, to comply with the Building Act	Cement (sand (20 mm OR builders' mix	1.25 3.5 4.5 6.75	(1 to 5.5)	15 kg 35 L 35 L 60 L	Damp SSD Wet	7.5 litres 10 litres 5 litres
<b>D</b>	<b>15 MPa;</b> max agg size 20 mm; slump 130 mm	General purpose, does not comply with the Building Act <sup>4</sup>	Cement (sand (20 mm OR builders' mix	1 4 4 6.75	(1 to 6.75)	12 kg 35 L 35 L 65 L	Damp SSD Wet	7.5 litres 10 litres 5 litres
<b>E</b>	<b>10 MPa Dry Mix;</b> max agg size 20 mm; slump 50 mm	Bedding concrete (fence posts etc) <sup>4</sup> does not comply with the Building Act <sup>4</sup>	Cement (sand (20 mm OR builders' mix	0.75 4 4 6.75	(1 to 9)	10 kg 35 L 35 L 65 L	Damp SSD Wet	5 litres 8 litres 2.5 litres

## Notes to Table 2:

- Use sand/aggregate OR builders' mix. Mix designs using separate sand and aggregate must be approved by a professional engineer or authorised representative if the concrete is for a structure covered by the Building Act. The values in brackets ( ) are the equivalent proportions of cement to builders' mix. If you cannot get a good mix it probably means the aggregates are poorly shaped or graded. To help with this add ¼ bucket of cement and an extra 1.5 litres of water.
- Most aggregates are damp when delivered. In this condition the sand can be squeezed into shape in the hand. For this condition use the amount of water for damp conditions.
  - If the sand is sticky and water can be squeezed out from it in the hand use the amount of water for wet conditions.
  - If the aggregate is too dry to be squeezed into shape use the amount of water for dry conditions.
  - If you follow the rule of adding about ¾ of the water first you can adjust the water requirements to suit the mix.
- Too much water will produce weak concrete with poor durability. The secret is to use as little water as possible, but too little water will make the concrete difficult to handle and use. A guide is that the concrete holds together when tipped out of the wheelbarrow, but is not so runny that it flows out of the barrow without assistance.
- The water required by a particular mix design can vary by 2.5 litres per 50 litre batch depending on the amount of water already in the aggregates. When they are very dry an extra 2.5 litres may have to be added. After rain or recent delivery of aggregate a smaller volume may be enough.
- The workability of the concrete is determined by both the water quantity and the amount of cement. Using the water quantities in Table 2, the 17.5/20 MPa mix will be "wetter" and easier to handle and place than the 30 MPa mix, but the 30 MPa will provide a more easily finished (and durable) surface.
- Proprietary pre-bagged concretes may also be suitable. Add the amount of water indicated on the bag.



# PART 5

## **FEED PADS**

---

# 1. INTRODUCTION

---

A feed pad provides a facility for the supplementary feeding of cows. Farm owners/clients who use a feed pad aim to maintain or increase quality or quantity of milk and avoid deterioration of tracks or pastures. Critical aspects in the design and construction of a feed pad operation are:

- Safe and easy access for stock
- Maintenance of animal health
- Adequate working space for farm staff and their equipment
- Storage of a range of feeds and easy access to them
- Efficient feeding out system
- Water supply
- Farm Dairy Effluent (FDE) containment
- Stormwater management
- Shelter.

The size and arrangement of the pad depends on the operation. The pad operation needs to be efficient, sustainable, and appropriate for herd size, as well as meeting regional council rules and regulations.

Tables 4.3 and 4.4 have been developed to provide general guidance on slab thickness and concrete strength selection depending on the intended feed pad durability and loading conditions.

## 1.1 SCOPE

This Practice Note part is limited to feed pads constructed with concrete pad surfacing and without a roof or covering structure. Part 4: Concrete Structures is directly relevant and should be read in conjunction with this part.

### Key Points

- **Regional council requirements for feed pads vary within New Zealand**
- **Concrete feed pads provide one of several off-pasture feeding options**
- **The feed pad site should only be confirmed after thorough site investigations have been completed**
- **The required feed pad area needs to take account of the proposed maximum stock numbers, feeding regime, access and vehicle turning movements**
- **Because of the acidic and corrosive environment created by stock on feed pad surfaces, these require a concrete designed for high durability to provide a long service life**
- **Concrete slab design needs to be reviewed by a CPEng**
- **Proper site preparation, placement and curing of concrete is critical to achieve the intended design performance**
- **The proposed effluent management system needs to be designed into the structure, not added in later**
- **An upgrade of the farm FDE system (including deferred storage) may be necessary to accommodate the additional FDE generated**
- **Constructing and maintaining a surface that is not rough or slippery is critical for animal welfare**

## 2. DECISION MAKING

### 2.1 OFF PASTURE OPTIONS

Feed pads are different to other off pasture feeding options. A feed pad is a defined hard surface area, typically concrete, sited adjacent to the farm dairy where stock can be held for a short period of time (up to two hours) either before or after milking, where water and supplementary feed can be provided. They are not designed for holding cows for extended periods of time. They may be covered, or uncovered.

As well as water, feed pads can be used to feed hay, silage, mixed rations or concentrates in times of pasture shortage. They can reduce the adverse impact of stock on pasture during wet conditions or pasture renovation. Concrete feed pads provide better supplement utilisation than supplement feeding on pasture.

On feed pads, the FDE flows down the concrete surface to the edge of the slab where it is channelled to a sump for collection and subsequent storage or irrigation disposal. Non-concrete hard surfaces such as gravel are not recommended for feed pads due to the combined challenges of keeping the surface clean, containing effluent and maintaining animal health.

Depending on the operation of the farm, other types of off pasture pad systems should also be considered. These are listed in Table 2.1. The general principles described in this Part apply to all types of feed pad, although the specific design features associated with covered pads are not included.

*Table 2.1: Some Types of Off-Pasture Pad Systems*

#### Some Types of Off-Pasture Pad Systems

**Stand-off (or Loafing) Pad:** Specially built uncovered areas where stock can be withheld from grazing during wet periods to minimise damage to pastures. Pads are constructed of free-draining material such as sand, bark, saw dust or woodchips on a sealed surface with appropriate drainage of liquid to an effluent storage facility. Because cows may be withheld for extended periods they need 8 to 10 m<sup>2</sup> per cow to allow room for lying down.

**Self-feed Pad:** Constructed where animals are withheld from pasture for extended periods and supplementary feed is given to them on an uncovered pad, for example over winter. As the herd may spend several months on the pad, the cows require a similar sized area as a stand-off pad to lie down on, in addition to a hard area for feeding.

**Animal Shelter:** These are covered facilities for when animals are held off pasture, usually for shorter term periods, and supplementary feeds are brought to them. Pad surfaces can be either concrete slatted floor with manure storage bunker or free-draining carbon material. They don't include designated areas for cows to lie down.

**Wintering Barn:** These are fully covered and enclosed facilities where animals are withheld from pasture for extended periods and supplementary feeds brought to them. They are commonly constructed with a concrete floor and have designated areas for cows to lie down on which have a softer surface (for example, rubber matting).

PART 5: FEED PADS



*Uncovered feed pad*



*Covered feed pad*



*Stand off*



*Self feed pad*



*Animal shelter*



*Wintering barn*

## 2.1.1 Surfacing

The critical consideration when choosing the type of pad system is usually the intended length of time cows will spend on its surface. The surfacing type chosen should be determined by a balance of factors including:

- The ability to feed out efficiently
- Longevity of the surface
- Ability to clean the surface and capture effluent
- Animal wellbeing.

The longer a cow spends on a hard or wet surface without being able to lie down, the greater the risk of stress and lameness.

If the pad is used for feeding only, then the cows should only be there for a few hours each day and in this situation a surface such as concrete is acceptable. However, if it is intended to use the pad for prolonged periods, such as for winter management, then a softer surface for animals to lie down on will be needed.

## 2.2 FEED PADS

While there are considerable benefits to be gained from installing a feed pad, the bigger picture needs to be considered before making a decision to proceed. The following farm management related questions should be carefully considered by the farm owner in consultation with their advisors.

*Table 2.2: Feed Pad Farm Management Considerations*

Feed Pad Farm Management Considerations
<ul style="list-style-type: none"> <li>• How will pasture management be adjusted to maximise efficiency?</li> <li>• How will a pad impact the farm's profitability?</li> <li>• What will the pad be used for?</li> <li>• How will animal health and welfare on the pad be managed?</li> <li>• How will the proposed system be operated long term, for example feed management?</li> <li>• Will a change in system align with goals for the farm?</li> <li>• Will the farm change to a higher input feeding system?</li> <li>• Does the farm have sufficient staff to run a supplementary feed system?</li> <li>• How will the increased effluent and stormwater generated from the pad be managed?</li> </ul>

An integrated farm planning approach is essential in deciding the site, size and viability of a pad. To be effective, a feed pad needs to be considered as one component in a whole farm system. It must take into account proposed future changes in the farming systems and herd size. At the outset, a cost versus benefit analysis should be undertaken to confirm viability.



*Feed pad in operation*

## 3. GENERAL DESIGN

### 3.1 REGULATORY

#### 3.1.1 Regional and district council rules

Different local authorities have different rules for feed pads, particularly around the means by which FDE is managed. However, they usually include rules about the construction materials and sealing requirements of the pad as well as proximity to boundaries, public roads, water bores and neighbouring houses. In some regions, the construction and/or operation of a new feed pad may be a non-compliant activity under existing land use and discharge consents, thereby invoking the need for a consent variation.

Therefore, the relevant regional and district councils must be consulted before construction to identify any rules or regulations that may apply for the proposed feed pad site.

#### 3.1.2 Ministry for Primary Industries

*NZCP1: Design and Operation of Farm Dairies* has been developed by the Ministry for Primary Industries (MPI) to assist the dairy industry in meeting certain aspects of the Animal Products Act 1999. For feed pads, factors such as feed storage, effluent containment and rodent control must be considered. MPI's *Code of Welfare, Dairy Cattle* is also relevant to feed pads. Parts of *NZCP1* and the Code of Welfare have been reproduced in Part 1: Legislation, section 8.

### 3.2 SITE SELECTION

Feed pads should be formed above the natural ground surface level to promote drainage. The design needs to allow for all-weather access by machinery and cows, as well as for waste removal. Positioning needs to be dictated by the location of the milking shed's access track and the holding yard and should be sited as multipurpose facilities which can be used to benefit the farm all year round.

*Table 3.1: Some Site Selection Considerations for Feed Pads*

#### Some Site Selection Considerations for Feed Pads

- Sufficient space for vehicles to access and easily turn
- Existing site services available (water, power, FDE storage and treatment, fresh water)
- Take advantage of any gentle slope (2 to 4 per cent)
- Make use of existing shelter belts
- Consider prevailing winds
- Proximity and accessibility to dairy shed and feed bunkers
- Room for future expansion
- Topography
- Ground water level
- Drainage features
- Clearance distance from property boundaries
- Minimum allowable distance from waterways and bores
- Ease of cow flow.

## 3.3 SITE INVESTIGATIONS

### 3.3.1 Survey

A topographic survey of the whole site will assist in optimising the feed pad location. Surface features such as buildings, trees, water courses, power and telecom lines, roads, races, and fences should be located and presented on a site plan. The location of buried services such as electricity and telecom cables, and water and gas lines also must be recorded on the site plan – before test pits are dug. The proposed pad “footprint” can then be overlain on the plan to determine its optimal positioning with respect to surrounding features and services.

The feed pad position should also be optimised to reduce the quantity of earthworks required. A pad surface requires sufficient slope to assist liquid drainage by gravity. A minimum surface slope of 2 per cent is usual and is equivalent to a fall of 20 mm over 1 m.

### 3.3.2 Test pits

Test pits across the site to at least 1 m below the finished depth of the concrete slab are essential to determine the type and characteristics of the sub soil materials present under the proposed pad. Locating the highest seasonal ground water level is critical as it will assist in determining the level of the base of the pad and its foundations.

Before digging a test pit, ensure no buried services are located under the proposed site of the pit.

Scala penetrometer tests to determine soil bearing pressures are recommended to calculate the depth of compacted gravel that should be placed on the prepared ground to provide foundation support, especially if it is intended to enclose the pad or cover it with a roof in the future.

## 3.4 DIMENSIONS

Feed pad dimensions will always need to be farm specific but general guidelines are:

- Allow feed lanes 4.5 to 6.0 m wide for easy tractor and feed-out wagon access as well as sufficient cow standing area
- Single lanes for cows only should be 4.0 m wide to allow cows to pass freely
- Length of the feed face for short-time feeding if all cows are able to feed at once should be 0.8 m per cow
- Length of the feed face if cows are feeding adlib should be 0.3 to 0.5 m per cow
- Entry and exit points, as well as turning areas for cleaning and feeding out, should be wide enough (at least 8 to 10 m) to allow free flow of stock and vehicles.

The area allowed per cow will affect their comfort levels. Cows standing in a yard before milking occupy between 1.2 m<sup>2</sup> (Jersey) and 1.5 m<sup>2</sup> (large Friesian) each, depending on breed. Where cows will be on the feed pad for short periods an area of at least 3.5 m<sup>2</sup> should be allowed for.

Any intended herd size increases, or changes in breed, need to be allowed for by providing flexibility to change the overall pad dimensions and configuration at a future time.



### 3.5 ORIENTATION

The orientation of a pad should be carefully considered. Relevant factors are:

- Can shade be maximised by positioning close to tree lines?
- Can the negative effects of prevailing winds be minimised?
- Is it intended to cover the pad with a roof structure or enclose it entirely at some future time? (This is very relevant on a sloping site). If so:
  - What type of roof structure would be constructed?
  - How would roof water be collected and disposed of?
  - How would the roof be supported from the ground?

### 3.6 SURFACE SLOPE

The recommended surface slope for feed pads is 2 per cent to address the following needs:

- Cow behaviour is improved where the surface slope is not greater than 2% (cows at greater grades become uncomfortable standing across a slope and will naturally turn up-hill)
- Ease of cleaning, and drainage of FDE
- Drainage of surface stormwater, which can effectively gravity flow downslope
- Research suggests a 2 per cent slope is optimal for flood wash. (At steeper slopes wash down becomes inefficient as rivulets will form leaving solids behind.)

### 3.7 COVERING

For economic reasons, farm owners/clients may consider constructing a feed pad in the short term but add a roof structure to provide shade and shelter for cows later. A roof can divert rainfall directly to stormwater so there is less FDE volume on the pad to manage.

Foundation requirements for a roof or covering structure that may be added later should be provided for during the concrete slab design stage as it will be subject to building consent and Building Code requirements.

Design of post foundation at this earlier stage may make any future addition covering less difficult and more cost effective. Firstly though, a cost versus benefit analysis should be undertaken as retrofitting a roof may not be as cost effective as first envisaged for some sites. However, short term financial benefits of not allowing for addition of a future roof structure may be overtaken by changes in future costs and overall economics of the farm operation. Therefore, reducing up-front cost should not be the only basis for the decision.

Guidance around the design and construction of structures suitable for covering feed pads is outside the scope of this Practice Note.



*Covered feed pad*

### 3.8 DRAINAGE

Good design around the drainage system is critical for both animal health and effluent management on the feed pad. All feed pad liquid, that is both FDE and stormwater, must be captured.

Key points around effective feed pad drainage is:

- Minimising the amount of water flowing into the pad area by using cut-off drains with subsoils encased in filter gravel to collect both ground and surface water. Areas prone to flooding or frequent high ground water levels should be avoided
- Where surface water flow onto the pad from beyond its perimeter could be an issue, a cut-off drain or stormwater channel around the exterior of the pad should be installed (for example around the outside of a perimeter nib wall)
- At times when the pad is not being used, the stormwater runoff should be able to be diverted to land through surface water channelling to reduce the volume that would otherwise be entering the FDE system
- Any stormwater contaminated with effluent needs to be collected and treated through the FDE system. If the pad has uncovered feed stored on it, such as silage, leachate may seep out and so this area must similarly discharge to the FDE system.

This Practice Note assumes for design and operation that feed pad slabs will be constructed wholly above maximum ground water levels.

### 3.9 ACCESS

Lameness can be a major problem in some herds. One cause is small, hard stones catching in cows' hooves when they step from the race onto a concreted area. Options for avoiding this include:

- Applying a compacted layer of softer rock as a capping material to the surface of the entrance race
- Installing a specifically developed proprietary geotextile fabric on the approach area
- Constructing a nib wall barrier at the feed pad access entrance.

The entrance to the feed pad is a collection point for effluent and needs to be sloped, well drained and diverted into the effluent treatment system.

### 3.10 WATER SUPPLY

An adequate water supply at the pad for stock is essential. Volumes required can be calculated by considering:

- Lactating cows require between 70 and 110 L of water per day
- Dry cows require 35 to 80 L of water per day
- When cows are fed more concentrated supplements with higher dry matter (DM) their water intake will increase above 70 L
- Adequate water must be available for cleaning purposes.

Water troughs should be placed well away from feed troughs and bins to reduce cross contamination by stock and ensure that dominant cows can't monopolise both the feed and water at the same time. Allowing a sufficient feed and drinking face width based on what works well on similar feed pads will also assist.

### 3.11 FEEDING FACILITIES

Supplementary feeds can be provided by a number of different feed distribution systems, including feed; bins, troughs, and lanes. Farm owners will usually have their own preferences as to the option they choose.

One of the more difficult aspects of a feed pad operation is ensuring cows are kept out of the feed. A few ideas to consider when designing a feed pad that will help mitigate this are:

- To make feed easily accessible, ensure that the inside floor of the bin, trough or feed lane is at least 200 mm higher than the feed pad. The ideal height will vary with the breed
- Place a 'hot' wire down the centre of the bin or trough. However, consider how the power will safely cross (preferably underground) to the feeding area
- A costlier but effective option is to install pipe head bails. These not only prevent cows from climbing into or being pushed into bins, they also prevent them from lifting their heads out of the bins and throwing feed around.

Concrete feed bins built into the slab have the advantage that they do not move when they are knocked during feed replenishment and consideration should be given to this in the design of the concrete slab. If feed bins that abut each other are able to move out of alignment, then feed can spill onto the ground. However, separate feed bins have the advantage of being easier to replace when damaged or when the configuration of the feed pad is changed for operational purposes.

The designer also needs to consider how bins, troughs and lanes can be cleaned out efficiently.

## 3.12 FEED STORAGE

Well placed supplementary feed storage areas can save costs through reduced spoilage, fuel use and travelling time. They also improve operational efficiency by optimising the distance between storage and feeding locations for convenience and safety, and reduce the length of road or track needed for transporting feed in.

Storage facilities that are integrated into the design of a feed pad itself will assist in reducing the impacts of spoilage from rain and surface water, and capture leachate runoff which can be toxic to aquatic life.

All stored feed is best contained in a covered bunker. Feed should be kept dry, protected and a minimum distance away from the milking area. MPI's code of practice *NZCP1* provides further guidance, and includes a section on stock feed storage reproduced in Table 3.2.

*Table 3.2: Extract from Chapter 5.9 Stock Feed Storage, NZCP1: Code of Practice for the Design and Operation of Farm Dairies*

### 5.9 Stock Feed Storage

- (1) Feeds containing grain, Palm Kernel Extract (PKE), and similar products should be stored in a feed silo situated on concrete or in covered concrete bunker. These are to be no closer than 10 m from the vat stand.
- (2) Feed that cannot be stored in a feed silo should be stored over concrete or, if a concrete area is not available, on a sheet impervious to moisture such as polyethylene. Storage must be at least 20 m from the farm dairy and not within 3 m of the edge of the farm roadway, and should not allow any water runoff to contaminate the feed pile, surface water or ground water source.
- (3) In addition:
  - (a) feed should not be stored directly on the ground;
  - (b) feeds containing grain, PKE, and similar products should be covered at all times to prevent water damage;
  - (c) feed must be stored so that it remains cool and dry;
  - (d) the feed storage area needs to be kept free of birds, rodents, insects and other vermin;
  - (e) the feed storage area should not be made of any materials that are likely to contaminate the stored feed with residues, such as tanalised timber;
  - (f) feed should not be stored on-farm for long periods; and
  - (g) mouldy or spoiled feed should never be fed to lactating dairy cows.

### 3.12.1 Storage bunkers

The walls and floor of reinforced concrete bunkers for feed storage must be capable of withstanding the hard knocks of tractors and other machinery, as well as having sufficient durability and depth of concrete cover over the steel reinforcement to resist corrosion from the very acidic leachate. See Part 4 for general information on concrete durability.

The bunker floor must also be watertight and extend out as a concrete apron in front of the bunker walls. A sloped floor with a nib wall and channel on the down slope side will keep any leachate in, and freshwater out. The leachate is then able to be channelled into the FDE system. Types of concrete structures that could be used to build feed storage are described in Part 4: Concrete Structures, section 4 and the general design of solids bunkers detailed in Part 2: Solids Separation, section 5.4.

### 3.12.2 Feed stacks

Stacks of feed (for example silage) should be placed on a drained concrete surface constructed with nib walls around the perimeter. Silage covers should extend over the feed and beyond the nib wall and be attached or weighted down on the ground. Rain water is then able to flow down off the cover and flow beyond the pad while the leachate is contained on the concrete.

As a feed stack pad surface is exposed to similar impact, scraping and acid leaching damage as a feed pad, the concrete slab should be similarly designed.

A concept design for a feed stock pad is illustrated in Figure 3.1.



*Feed stack pad*

Figure 3.1: Feed Stack – Concept Details (previously Figure 4.1)

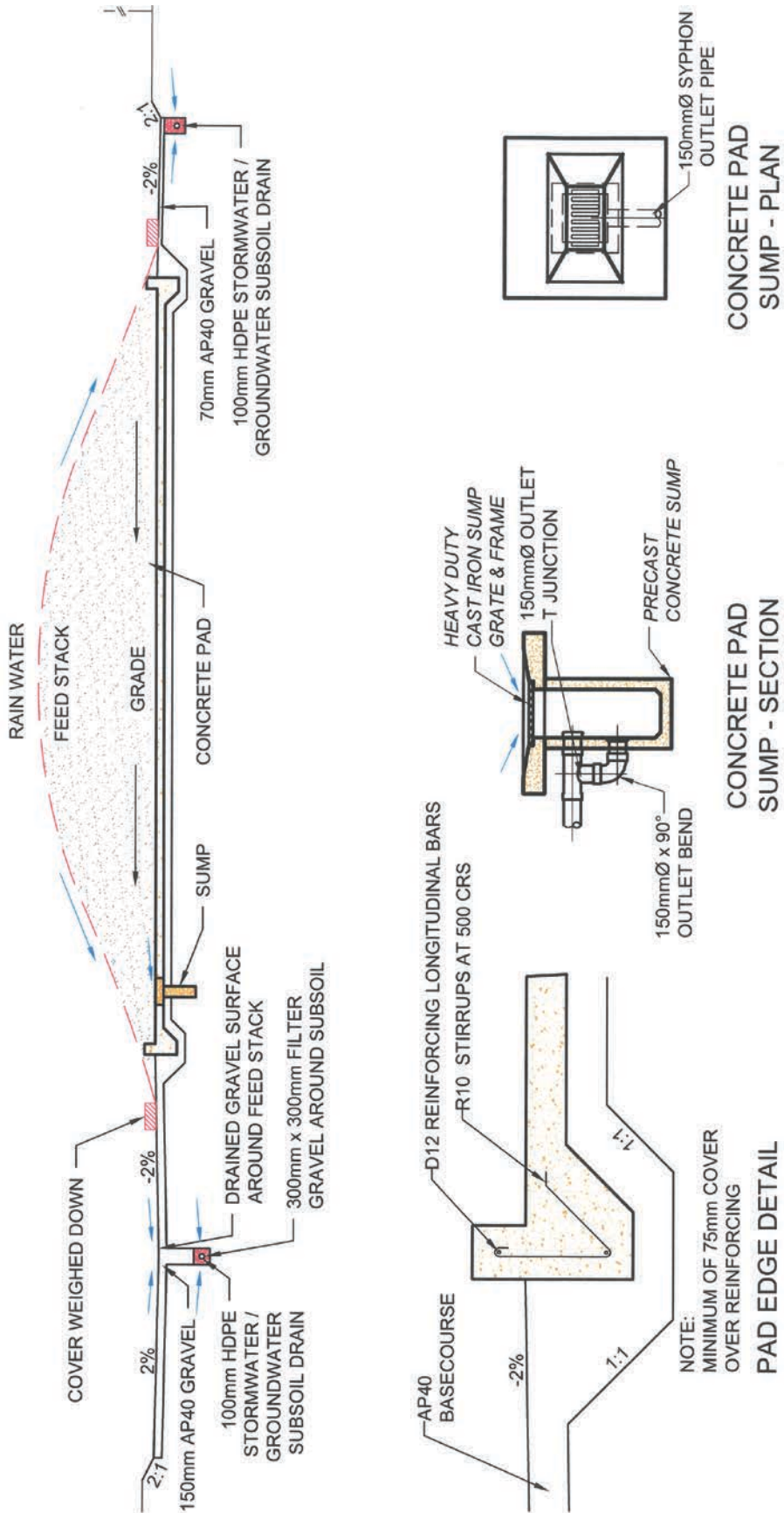

## 4. CONCRETE SLAB DESIGN

### 4.1 SLAB DESIGN CONSIDERATIONS

Prior to the design of any concrete slab structure the proposed feed pad site must be fully assessed. Its design should include the following key considerations.

*Table 4.1: Concrete Slab Design Considerations*

Concrete Slab Design Considerations
<ul style="list-style-type: none"> <li>• Ground conditions under the slab, including soil type, moisture and plasticity</li> <li>• Maximum ground water level</li> <li>• Levels and grades along the site so to provide effective gravity drainage into the FDE system</li> <li>• Size and shape of the slab</li> <li>• Proposed design life of the slab</li> <li>• Slab surface and serviceability expectations</li> <li>• Intended operation of the feed pad, including means of stocking with feed, vehicle turning areas, cleaning and maintenance</li> <li>• Likely exposure conditions (moisture, soil and groundwater chemistry, acids from FDE and feed leachate, abrasion, freeze-thaw cycles)</li> <li>• Available budget.</li> </ul>

Many factors will influence the design and construction of a concrete feed pad slab but their individual impacts will vary from site to site. The desired level of durability of the slab should be reflected not only in the design adopted but also in the budgeted amount set aside for the work. A lower construction cost may inevitably require making considered design and performance compromises.

Part 4: Concrete Structures gives general guidance for reinforced concrete design and construction and should be read in conjunction with this Part. Aspects specific to concrete feed pads are outlined in the following sections.

### 4.2 DESIGN LIFE

Farm owners should be asked, how long do they need this feed pad structure to last, that is, what is the design, working or intended life.

If it is a temporary structure, it may be more economical to overlook durability requirements. However, in cases where a large economic investment is being made it should be designed for durability. For covered structures, the Building Code and NZS 3604: Timber-Framed Buildings require concrete slabs to perform as designed for at least 50 years without needing reconstruction or major renovation.

Part 4 section 4.1.1 of this Practice Note describes typical “life” for structures covered by the New Zealand Building Act.

### 4.3 EXPOSURE AND LOAD CONDITIONS

Depending on the site and operation, feed pads are subject to different environmental exposure and load conditions, including those listed in Table 4.2. Design life and serviceability expectations, will also have a significant impact on the slab.

*Table 4.2: Slab Design – Exposure and Load Conditions*

Slab Design – Exposure and Load Conditions
<ul style="list-style-type: none"> <li>• Acidic materials (e.g. FDE, leachate from feed, and some cleaning materials) in wet conditions</li> <li>• High abrasion from dairy cattle, FDE scraping and manoeuvring vehicles</li> <li>• Thermal movement from temperature variations</li> <li>• Impact loading from machinery such as loader buckets</li> <li>• Exposure to seawater or sea spray.</li> </ul>

Concrete exposed to acidic materials such as those present in FDE or feed leachate will soften, and be easily abraded or eroded. Therefore, the thickness of such slabs will be governed not only by the structural load requirements, but also by the depth of cover concrete required to protect the reinforcement from being exposed and corroded.

## 4.4 CONCRETE DESIGN – DURABILITY

Concrete can be designed to operate for a prescribed design life with minimal maintenance in a wide range of conditions. Part 4 gives further information on concrete durability, and should be read in conjunction with this part.

In general, the stronger and less permeable the concrete surface and cover concrete, the more durable the element will be. Durability is further influenced by the depth of concrete cover over the reinforcement and by cracks and joints. Feed pads in environments subject to frost needs to be constructed from concrete that's resistant to freeze-thaw attack.

Abrasion resistance is critical for feed pads. Table 4.3 provides guidance for minimum compressive strength for feed pad abrasion resistance. 30 MPa is the minimum recommended concrete compressive strength for permanent structures to satisfy structural requirements (see Table 4.4). However, for feed pads subject to high abrasion, 40 MPa may be appropriate to provide adequate durability.

Table 4.3: Selection Guide for Concrete Slab Floors (adapted from NZS 3101: Part 1: 2006, Table 3.8 – Requirements for Abrasion Resistance for a Specified Intended Life of 50 Years.)

Service Conditions	Application	Finishing Process	Curing	Min. Specified Compressive Strength at 28 days (MPa) (f' <sub>c</sub> )
High Abrasion	Cow standing areas subject to feed out and scraping vehicle movements, (for example feed pads)	Power floating and at least two passes with a power trowel before applying a slip resistant surface texture	7 days' water curing using ponding or covering; or the use of curing membrane that meets NZS 3109	40 MPa
Moderate Abrasion	Cow standing areas with light vehicular traffic only, (for example dairy yards)			30 MPa
<p><b>Note:</b></p> <ul style="list-style-type: none"> <li>• 30MPa with supplementary cementitious material (SCM) (or type GB cement instead of type GP plus SCM) is generally considered acceptable for durability in chemically-aggressive farm environments, particularly for design life 50 years or less.</li> <li>• If the SCM is slag (or slag cement) rather than microsilica it would be more appropriate to specify 30MPa at 56 days.</li> <li>• Microsilica is usually added at about 8% replacement of the type GP cement.</li> <li>• Concrete containing SCM needs wet curing, and is susceptible to plastic shrinkage cracking before setting unless precautions are taken.</li> </ul>				

#### 4.4.1 Curing

Proper curing is essential to ensure the required durability and strength is achieved. It is particularly important for durability, which is largely determined by the quality of the concrete surface and cover concrete. Therefore, it should not be reduced in the construction process in an attempt to save time or money.

Higher strength concrete and concretes containing a supplementary cementitious material (SCM) are susceptible to cracking within hours of placement under weather conditions that promote rapid drying of the concrete surface. Special precautions must be taken in such conditions to prevent cracks caused by evaporation from the slab during the finishing process.

More information on concrete specification and construction including ordering and storing materials, mixing concrete, placing, finishing, curing, and cutting joints to control cracking is outlined in Part 4: Concrete Structures and *IB 55*.

## 4.5 CONCRETE DESIGN – LOADING

Table 4.4 provides recommendations applicable to concrete feed pad slabs for given load conditions and should be read in conjunction with other design guidance provided in this Practice Note. If the slab design is to be meet both, durability (Table 4.3) and loading minimum concrete strength requirements (Table 4.4), then the selected minimum concrete strength should be the higher of the two values.



*Table 4.4: Nominal Slab Thicknesses, Concrete Strength and Reinforcement for Typical Farm Loading Conditions – Developed from CCANZ IB 55*

Slab Loading	Temporary Structure			Design Life 50 Years		
	Minimum Slab Thickness (mm)	Minimum Concrete Strength (MPa)	Reinforcement	Minimum Slab Thickness (mm)	Minimum Concrete Strength (MPa)	Reinforcement
<b>Cattle &amp; quad bikes only</b>	100	25	2.27 kg/m <sup>2</sup> or Mesh Type 665 (minimum of 30 mm from the top surface)	150	30	3.40 kg/m <sup>2</sup> or Mesh Type 663 (minimum of 30 mm from the top surface)
<b>Less than 3 tonnes</b>	125	25		150	30	
<b>3–10 tonne</b>	125–150	25		150	30	
<b>Over 10 tonne</b>	Design should be undertaken by a structural designer with experience in the design of ground floor pavements					

## 4.6 CRACK CONTROL

Cracks allow moisture and air to penetrate to the surface of the reinforcing steel, making it more susceptible to corrosion. Cracks allow water and aggressive chemicals to penetrate below the concrete surface exacerbating deterioration, such as freeze thaw and acid attack that would otherwise be limited to the concrete surface. Impact by stock and machinery will cause the crack edges to frit, widening the crack at the exposed concrete surface.

Therefore, in an aggressive environment like a feed pad, cracked concrete will be less durable than uncracked concrete of the same mix design.

Cracks can harbour dirt and microorganisms, thus presenting animal hygiene issues and making the floor more slippery in the immediate area of the crack. They may also trap stones and other hard debris that then protrudes from the concrete surface, causing problems for stock and machinery.

Concrete shrinks as it hardens and dries. To accommodate this shrinkage and prevent wide, random cracking, careful reinforcement detailing and pre-formed or early cut joints are used. The joints must be in place before the concrete starts to shrink, no later than 24 hours after placing in summer or 48 hours in winter.

Reinforcing mesh will help to control cracking in larger slabs. Mesh should never be used without joints. Joints control the position of shrinkage cracks by introducing straight joints at predetermined locations. Joints need to be sealed with an appropriate sealant to stop moisture and solids getting into the joint.

Tables 4.5 and 4.6 describe types of joints, where and when they should be used.

Table 4.5: Types of Joints

Types of Joints	
<b>Free Joint</b>	A joint where horizontal movement is allowed for. The mesh reinforcement (or other reinforcement) is discontinued at the joint, which is connected horizontally with a de-bonded bar and allows for horizontal movement but prevents differential settlement.
<b>Tied Joint</b>	A joint where the mesh reinforcement (or other reinforcement) is continuous across the joint that has a groove or saw cut one quarter (¼) of the overall depth at the surface (30 mm minimum).  <b>Note:</b> where mesh is used, it should be securely positioned below the base of the intended saw cut. After curing, a sealant should be injected into the cut to prevent subsequent moisture ingress into the joint. Sealant manufacturers will be able to identify suitable products to meet the hygiene and durability requirements of this environment.

Table 4.6: Joints in Reinforced Concrete Slab

Slab Size	Free Joint	Tied Joint
Slabs less than 20 m in either direction	-	Every 5 m
Slabs greater than 20 m in either direction	At least every 20 m (if less than 40 m incorporate one free joint)	Every 5 m (maximum of 4 bays)

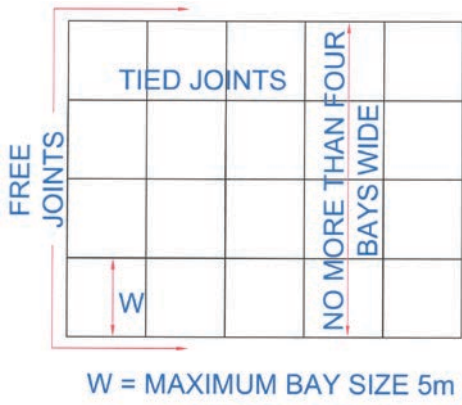

For slabs that are not categorised as having to meet the Building Code and where reinforcement is omitted, joint spacing (free joint) should be reduced to 3 m intervals.

More information on joint options, layout and construction is available in CCANZ IB 55, NZS 3604 and BRANZ guidelines.

Prestressed concrete may be used to minimise cracking without the use of joints, thereby avoiding the need for maintaining joint sealants. Cast *in situ* prestressed concrete slabs must be designed and constructed by specialist contractors.

Prestressed precast floor units are another alternative. Prestressed construction is more expensive than cast *in situ* reinforced concrete so is likely to be suitable only for large feed pads or where there is poor ground.

## 4.7 REINFORCEMENT

As previously described, the primary function of reinforcing mesh in feed pad concrete slabs is for crack control. However, reinforcement also makes the slab more robust and less susceptible to severe deformation and break up. Slab reinforcement typically consists of mesh, supplemented with mild steel deformed bars of varying diameter and tensile strength around slab edges.

If reinforcement is not accurately positioned it will not function as intended. A feed pad slab placed on a well-prepared surface is at greater risk from shrinkage cracking than from excessive loading. Therefore, the mesh should be placed in the top third of the slab to control shrinkage cracking, rather than lower in the slab to control flexural cracking.

Chairs are used to raise the reinforcement to the required height. To protect the steel from corroding, the depth of concrete cover over the steel should be at least 30 mm, plus the depth of any proposed grooving. NZS 3101 specifies cover depths for different strengths of concrete.

As an alternative, fibre reinforcement may be used when loading conditions permit. Structural synthetic fibre reinforcement systems do not corrode and thus may be beneficial in feed pads. If fibres are to be used, then fibres suitable for the loading and service conditions must be used. Structural fibres in this application must have the ability to bridge cracks without breaking. Professional advice should be sought when considering using fibre reinforced concrete (refer CCANZ *IB 39*). Note that steel fibres should not be used because if they protrude from the concrete surface they could injure stock.

## 4.8 DAMP PROOFING

Concrete will reduce water and water vapour rising up from the ground through capillary action, but is less effective if the water table is already high. Consequently, it is recommended that damp proofing be laid beneath all slabs that will house animals, be used for storing feed, or could have buildings on them, as it will reduce deterioration of materials in contact with the concrete.

A damp proofing membrane generally consists of a layer of polythene sheet, at least 0.25 mm thick, placed under the slab. To be effective, damp proofing must be installed across the whole area and penetrations and laps taped to prevent the passage of moisture through them.

Damp proofing requires the same ground preparation as casting directly onto ground or granular fill. Section 5.1 describes the ground preparation necessary.

## 4.9 DESIGN GUIDANCE

In this Practice Note, Part 4: Concrete Structures provides further design guidance on aspects directly relevant to feed pads. Sections of particular interest are:

*Table 4.7 Relevant Sections from Part 4: Concrete Structures*

Section	Item
4.1.1	Specified Intended Life
4.1.2	Factors Affecting Durability
4.2.1	Cracking
4.3	Compressive Strength
4.4	Specifying Concrete
4.5	Curing
5.1	Reinforced Concrete
7.3	Storage Structures
7.4	Foundations
7.5	Floor Slabs
7.6	Nib Walls
7.7	Surfacing

## 5. CONCRETE CONSTRUCTION

### 5.1 SITE PREPARATION

Ground preparations for the concrete slab should include the following steps:

- (i) Remove all vegetation, rubbish, organic top soil and soft ground from the site. It may be necessary to dig out soft spots or excavate to a lower level to obtain “Good Ground” as defined in Table 5.1)

*Table 5.1: “Good Ground” as defined by Compliance for New Zealand Building Code, Clause B1 Structure, Definitions*

#### **Good Ground**

Means any soil or rock capable of permanently withstanding an ultimate bearing pressure of 300 kPa (i.e. an allowable bearing pressure of 100 kPa using a factor of safety of 3.0), but excludes:

- (a) Potentially compressible ground such as topsoil, soft soils such as clay which can be moulded easily in the fingers, and uncompacted loose gravel which contains obvious voids,
- (b) Expansive soils being those that have a liquid limit of more than 50% when tested in accordance with NZS 4402 Test 2.2, and a linear shrinkage of more than 15% when tested, from the liquid limit, in accordance with NZS 4402 Test 2.6, and
- (c) Any ground which could foreseeably experience movement of 25 mm or greater for any reason including one or a combination of: land instability, ground creep, subsidence, (liquefaction, lateral spread – for the Canterbury earthquake region only), seasonal swelling and shrinking, frost heave, changing ground water level, erosion, dissolution of soil in water, and effects of tree roots.

#### **Comment:**

Soils (excepting those described in a), b) and c) above) tested with a dynamic cone penetrometer in accordance with NZS 4402 Test 6.5.2, shall be acceptable as good ground for building foundations if penetration resistance is no less than:

- (a) 3 blows per 75 mm at depths no greater than the footing width.
- (b) 2 blows per 75 mm at depths greater than the footing width.

Depths shall be measured from the underside of the proposed footing.

- (ii) If the ground is deemed not “good ground” it may be possible to excavate further to reach ‘Good Ground’ and then backfill. Otherwise, advice should be sought from a geoprofessional.
- (iii) Depending on the design finished level of the slab it may be necessary to replace unsuitable material with a compacted granular fill up to the required height (see Table 5.2).

*Table 5.2: Granular Fill Guide*

#### **Granular Fill**

For a concrete slab, a layer of granular fill generally needs to be placed above the prepared subgrade, to raise the finished level of the concrete to the required height above ground level and to prevent storm and ground water being absorbed into the concrete. The granular fill should preferably have a well graded particle size distribution with a low percentage of fine clay and silt particles. Aggregates meeting NZ Transport Agency (NZTA) grading distribution requirements for M/4 AP 20 or AP 40 are suitable.

As a guide, granular subgrades will require 100 mm, whereas clay subgrades will need a much greater thickness. A typical maximum fill thickness is 600 mm with compacted individual layers of 150 mm thick.

- (iv) Compact the formation with a vibrating roller of sufficient capacity to achieve an effective allowable bearing pressure of more than 100 kilopascals
- (v) Incorporate subsoil and perimeter drainage where necessary
- (vi) The ground surface (also known as the subgrade), should be compacted and levelled to provide a firm surface and drainage fall across the site
- (vii) The top of the granular fill should be as smooth as possible and may need to be blinded with sand or a fine aggregate to achieve this. An uneven surface will restrict movement of a slab as it dries and shrinks, and this could lead to unexpected concrete cracking
- (viii) Place the damp proofing membrane if one is to be used, OR
- (ix) Spray the finished ground surface with clean water so that it is adequately wet. If concrete will be poured directly onto the ground, spray the finished ground surface with clean water so it is adequately wet to avoid water being absorbed away from the concrete.

## 5.2 CONCRETE PLACEMENT

CCANZ's information bulletin *IB 55: Concrete for the Farm* provides very useful commentary on the process of placing concrete. Key points about good practices in concrete construction are highlighted below.

### 5.2.1 Concrete in hot and cold weather

If the concrete cannot be protected from freezing conditions for two to seven days after placing, it may become damaged by the formation of ice within the pore structure. In very hot weather or strong dry winds the concrete may stiffen prematurely leading to poor compaction and finishing. In hot dry conditions the concrete may also dry out too fast which can cause cracking and a reduction in strength gained as the hydration or hardening process can only occur in presence of moisture.

If it is necessary to mix and place concrete in either very hot or very cold weather, precautions must be taken to ensure that the concrete is not damaged or adversely affected by the ambient weather conditions. **Concrete should not be placed on frozen or dry ground.**

What is too hot or too cold? NZS 3109 (Concrete Construction) discusses a range of 5 to 30 degrees Celsius. Table 5.3 outlines CCANZ recommendations for concrete mix design and placement for temperatures below 5 degrees, or above 30 degrees Celsius. Note that the provisions for mix design are intended for ready mixed concrete, for which the supplier is responsible for all aspects of mix design.

Table 5.3: Controlling the effects of hot and cold weather – CCANZ website, Technical Information, [www.ccanz.org.nz/page/Hot-and-Cold-Weather-Concreting.aspx](http://www.ccanz.org.nz/page/Hot-and-Cold-Weather-Concreting.aspx)

Aspect	In Hot Weather	In Cold Weather
<b>Preplanning</b>	<ul style="list-style-type: none"> <li>• Preplan carefully to avoid delays at all stages</li> <li>• Have standby equipment and manpower for all stages</li> <li>• Pay particular attention to speed of application, effectiveness and duration of curing arrangements</li> <li>• Schedule night time placement if possible.</li> </ul>	<ul style="list-style-type: none"> <li>• Preplan carefully to ensure adequate equipment and manpower available especially if there is a likelihood of temperatures below 0°C.</li> </ul>
<b>Concrete</b>	<ul style="list-style-type: none"> <li>• Use water reducing retarding admixtures in the concrete</li> <li>• Reduce the temperature of the concrete by (in order of effectiveness):</li> <li>• Reducing temperature of aggregates</li> <li>• Using liquid nitrogen injections in the mixed concrete</li> <li>• Reducing temperature of mixing water</li> <li>• Using SCM to reduce heat of hydration</li> <li>• Reducing temperature of cement.</li> </ul>	<ul style="list-style-type: none"> <li>• Reduce the setting time of the concrete by (in order of effectiveness):</li> <li>• Heating mixing water (maximum 70°C)</li> <li>• Using (chloride-free) accelerating admixture</li> <li>• Using higher cement content</li> <li>• Using high-early-strength cement.</li> </ul>
<b>Batching, mixing and transporting</b>	<ul style="list-style-type: none"> <li>• Shade batching, storage and handling equipment or at least painting with reflective paint</li> <li>• Discharge transit mixer trucks as soon as possible.</li> </ul>	
<b>Placing and Compacting</b>	<ul style="list-style-type: none"> <li>• Shade reinforcement, formwork and subgrades if possible and spray with water</li> <li>• Ensure that slabs have minimum “fronts” to which concrete is added</li> <li>• Place concrete in walls and deep beams in shallow layers</li> <li>• Use burlap covers if there is any delay between load deliveries.</li> </ul>	<ul style="list-style-type: none"> <li>• Thaw frozen subgrades and heat frozen forms (particularly steel) before placing concrete</li> <li>• Warm, insulate or enclose handling and placing equipment.</li> <li>• Avoid delays in handling and placing.</li> </ul>
<b>Finishing and Curing</b>	<ul style="list-style-type: none"> <li>• Use sunshades and windbreaks to lengthen finishing time (or, if hot/dry winds present, to control plastic shrinkage cracking)</li> <li>• For flatwork, use aliphatic alcohol after initial screeding if hot/dry winds present</li> <li>• Use revibration to correct plastic shrinkage cracking</li> <li>• Use water curing as the preferred method for at least 24 hours</li> </ul>	<ul style="list-style-type: none"> <li>• Maintain concrete temperature until safe strength reached by means of form insulation, insulated covers or heated enclosures</li> <li>• Delay striking of formwork for as long as possible</li> <li>• Avoid thermal shocks and temperature variations within a member. This includes not using cold water for curing, and removing protective measures gradually.</li> </ul>

## 5.2.2 Compaction

Once in place, concrete must be compacted to remove large air voids which would otherwise weaken it. Pumped concrete must be compacted even though it may appear because of its high workability to be well consolidated when placed. Concrete floors that are subject to corrosive substances or abrasion, like feed pads, must be compacted with a mechanical vibrator. A vibrating screed is best for floor slabs but an immersion poker vibrator will be required around the perimeter of the screeded area.

## 5.2.3 Finishing

Floor slabs are finished in four stages.

*Table 5.4: Finishing Stages*

Stage	Activity
1	Screeding to provide the correct level
2	Smooth the surface with a float
3	Leave the concrete to bleed
4	Densify the surface by trowelling

Because feed pads are subject to corrosive attack by FDE and leachate from the feed, they must be worked with a steel trowel into a hard, dense surface. While trowelling at repeated intervals will increase the hardness and durability of the surface, it will also produce a smooth and very slippery finish. In this Practice Note, options to improve the slip resistance are include in Part 4 section 7.7.2.

## 5.2.4 Curing

Concrete hardens and gains strength by chemical reaction between water and cement, not by drying. Therefore, it must be cured to prevent loss of moisture. Curing must start as soon as possible after the final stages of concrete finishing. If proper curing is omitted in an attempt to save money, the concrete will not achieve its required strength or durability. Feed pads in relatively abrasive environments must be cured for at least 7 days after casting. Curing for at least three days may suffice for feed pads in less aggressive conditions. Typical curing options are as follows.

*Table 5.5: Curing Options*

Curing Options	
<b>Water cure</b>	The entire concrete surface is kept continuously wet by ponding, mist spray or sprinkler.
<b>Polythene cure</b>	The surface is wetted and covered with polythene, the edges of which are tightly secured and sealed to prevent moisture loss.
<b>Curing compound</b>	Apply a proprietary curing compound complying with AS 3799 in accordance with the manufacturer's specifications.





*Feed pad under construction*

*(Note in the foreground the flood washing pipe outlets built into the slab structure)*

To prevent early age shrinkage cracks from appearing, it is recommended that the joints are formed on the day of the pour as changes in temperature overnight may lead to early cracking.

## 6. EFFLUENT MANAGEMENT

### 6.1 FEED PAD EFFLUENT

Feed pad effluent is different to normal dairy shed effluent in the following ways:

- It has a higher solid content, due to feed wastage being combined with dairy effluent during cleaning and a higher fibre diet
- Contains a greater amount of fibrous material
- Feed pad effluent has a higher nutrient content than farm dairy effluent
- Nutrient content is affected by feed type and feed quantity. Different feeds have different nutrient concentrations; effluent will reflect these nutrient variations. The quantity of feed offered or the percentage of the diet supplemented on the pad also reflects in the nutrient content of the effluent.

Effluent planning is a key component in feed pad design, and must be considered during the design stage and integrated into the structure at construction time. Designing and retrofitting an FDE system to a new feed pad after construction will tend to result in a less than optimal system as well as being more expensive than it might otherwise have been.

Factors to be considered when designing a feed pad include those as listed in Table 6.1.

*Table 6.1: Effluent System Design Recommendations for Feed Pads*

Effluent System Design Recommendations for Feed Pads
<ul style="list-style-type: none"> <li>• All effluent produced on feed pads must be contained and directed into a specifically designed FDE system for the site that includes storage</li> <li>• Maximise the difference in levels between FDE system components to provide gravity flow of effluent, ground and storm water</li> <li>• Consider using passive or mechanical separation methods to remove solids before irrigating to pasture</li> <li>• Existing sludge beds and anaerobic ponds, if used, will need desludging more regularly</li> <li>• Scraping of sealed surfaces will reduce the volume of water required for cleaning</li> <li>• A feed pad represents a large surface catchment area capturing stormwater that can enter the FDE system</li> <li>• Install a mechanism to divert clean stormwater off the feed pad area when not in use</li> <li>• Consider using a chopper pump in the feed pad effluent holding sump to reduce the fibre size of solids and hence incidence of downstream blockages.</li> </ul>

FDE from feed pads can be treated using many different methods and depends on factors such as the farm layout and other infrastructure present. Figure 7.1 shows typical FDE systems that can be used with feed pads.

The farm's existing effluent system may need to be modified if the proportion of solids in feed pad effluent is substantially higher than that of dairy shed effluent. For example, some changes to the solids separation system may be required. Solids separation systems function optimally at differing percentages of dry matter (in solids by mass). Part 2: Solids Separation section 3 of this Practice Note details the more common types of separation methods available.

Figure 6.1: FDE System Options for Feed pads

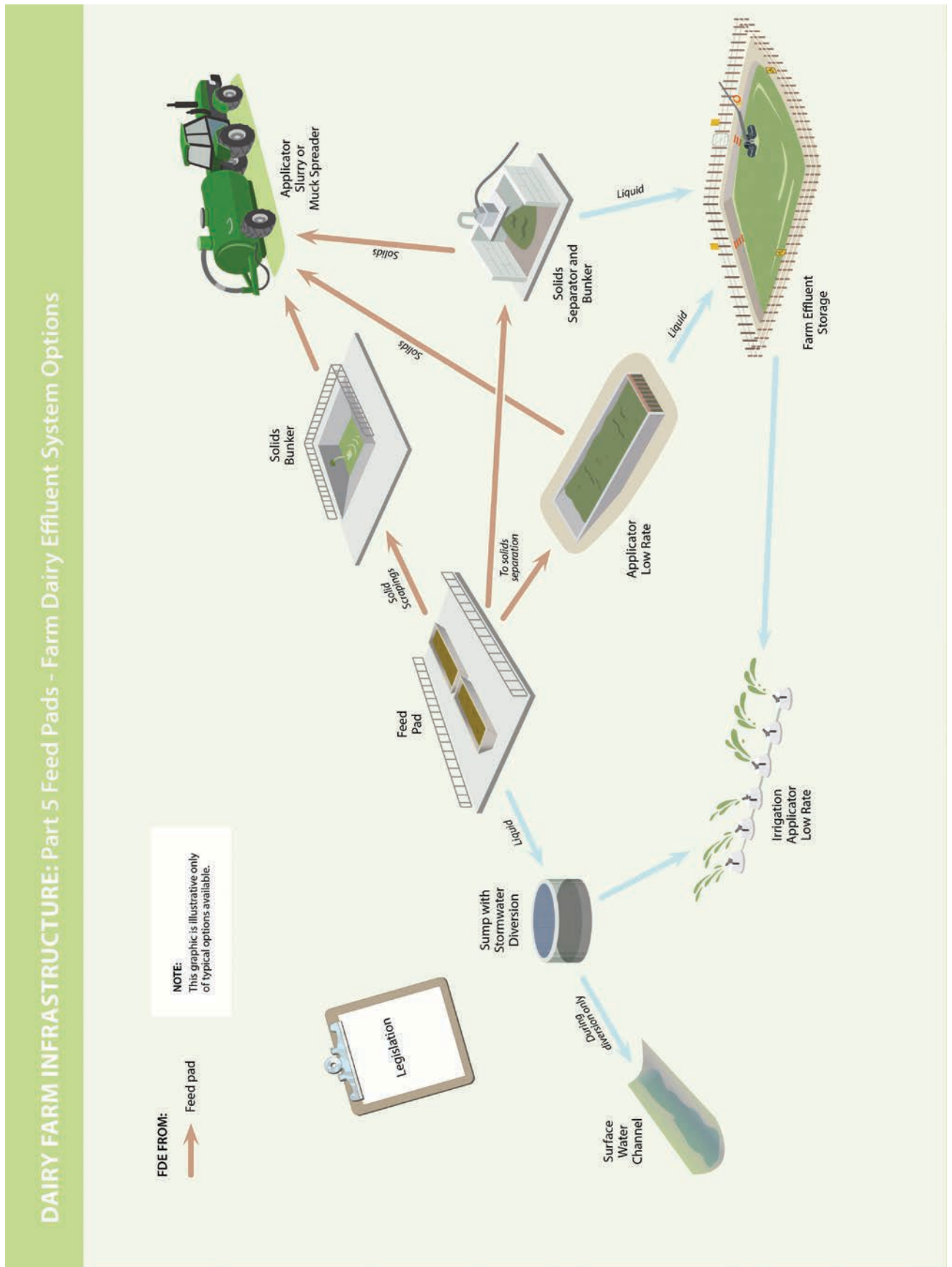

## 6.2 CLEANING

Any feed pad design developed must incorporate provision for the intended cleaning process.

Cow lane surfaces can accumulate FDE along with muck transported in and require regular cleaning. Options for removing FDE and cleaning the concrete surface are shown in Table 6.2. The preferred method at a given time will be determined by the availability of water and staff.

*Table 6.2: Clean Down Options*

Cleaning Method	Advantages	Disadvantages
<p><b>Scraping:</b> Use a 2-to-3-metre-wide blade fitted to a quad bike or smaller tractor. A sprinkler system to pre-wet the concrete can assist.</p>	<ul style="list-style-type: none"> <li>• Lower capital cost</li> <li>• Solid effluent easier to handle than liquid</li> <li>• Relatively quick clean up.</li> </ul>	<ul style="list-style-type: none"> <li>• Some labour cost</li> </ul>
<p><b>Scraping and Draining:</b> Solids are scraped up slope into a bunker at the top end of the feed pad while the liquids gravity drain into a sump at the bottom end.</p>	<ul style="list-style-type: none"> <li>• Provides an initial separation into solids and liquid parts which can each be treated differently.</li> </ul>	<ul style="list-style-type: none"> <li>• Some labour cost</li> </ul>
<p><b>Hosing:</b> Hand held hosing from several hydrants around the pad.</p>	<ul style="list-style-type: none"> <li>• Low capital cost.</li> </ul>	<ul style="list-style-type: none"> <li>• Higher labour cost</li> <li>• Splashing of feed area</li> <li>• High volume of FDE generated.</li> </ul>
<p><b>Flood washing:</b> A high volume/low pressure deluge cleaning system, typically a pipe riser from a stored water supply. Drainage divided into multiple channels to aid washing.</p>	<ul style="list-style-type: none"> <li>• Lower labour cost</li> <li>• No splashing feed area</li> <li>• Can accommodate green water reuse.</li> </ul>	<ul style="list-style-type: none"> <li>• Higher capital install cost</li> <li>• High discharge rates (12 to 15 m<sup>3</sup>/min)</li> <li>• Large volume of FDE generated (using clean water).</li> </ul>



*Scraping*



*Flood washing*

Feed bins must be regularly cleaned so that food quality is maintained. Regular dry scraping of feed bins is usually sufficient along with washing down as and when required. Holes through the end of the lowest bin will assist with drainage.

## 6.3 GREENWATER REUSE

Greenwater reuse, also known as green water recycling, is where FDE that has been mechanically or passively separated is pumped back and stored alongside the feed pad for use in wash down.

Unlike for dairy sheds, *NZCP1: Design and Operation of Farm Dairies* section 6.10 (4) allows dairy yards and feed pad surfaces to be cleaned using reused separated effluent water.

*Table 6.3: Excerpt from NZCP1: Design and Operation of Farm Dairies,*

### 6.10 Cleanliness of Premises

- (4) Water recovered from the farm dairy effluent system must not be used within the farm dairy except to clean the dairy yard, in which case:
- (a) the system operates at low pressure, with no detectable mist or aerosol;
  - (b) the water recovery system is of a design that will consistently deliver water that does not contain excessive sediment or offensive odours and is acceptable to the Farm Dairy Assessor;
  - (c) the system must be of a fixed design and must not include hand held hoses;
  - (d) if pumped, the delivery outlet is to be fixed at no more than 300 mm above the yard surface;
  - (e) the system must be completely separate from the fresh water wash down system which must still be available;
  - (f) the yard must be of concrete construction with no surface cover, and rinsed with clear water if necessary to remove any residual sediment;
  - (g) the recovered water will not be used within 5 m of the milking, milk handling or milk storage areas, or in roofed areas;
  - (h) the activity does not have a negative impact on the:
    - (i) hygiene status of the milking and cleaning equipment, milking area, milk handling and milk storage areas;
    - (ii) water used in the farm dairy for other purposes;
    - (iii) cleanliness of milking animal teats and udders; or
    - (iv) any other thing that might lead to contamination of the milk.
  - (i) the raw milk is not supplied for the manufacture of unpasteurised dairy products, or for consumption without heat treatment;
  - (j) any additional storage of or recovered water must be at least 20 m from the farm dairy and, if within 45 m, must be enclosed and not exceed 30,000 L capacity;
  - (k) the recovered water and its storage must not introduce offensive odours;
  - (l) the Farm Dairy Operator has documented the design and follows written procedures that are sufficient to ensure the requirements detailed in this clause are met; and
  - (m) all other requirements under this clause and clauses 3.8 Minimum Approved Distances and 4.3 Effluent Drains and Sumps are met.

Recycled effluent water must not be used to clean feed bins or lanes. Tanks, pipework and hoses used for greenwater must be clearly identified to prevent greenwater mistakenly being used for structures in contact with stock feed.

Whatever wash down option is selected there are advantages in adopting reused greenwater for feed pad wash down water. This approach can reduce the volume, and cost, of fresh water that needs to be supplied to the farm.

## 6.4 STORAGE CALCULATION

FDE captured from a feed pad needs to be retained in a pond or tank until soil conditions are suitable for disposal through pasture irrigation. This containment is known as deferred FDE storage.

As the total volume of FDE captured on the farm will increase, from rainfall, wash down water and excreted material from the feed pad, a check needs to be made to confirm that sufficient deferred FDE storage will be available on the farm.

The *Dairy Effluent Storage Calculator* (DESC) has been developed by Massey University. The DairyNZ document *A guide to using the Dairy Effluent Storage Calculator*, provides details on how feed pad information can be entered into this purpose designed DESC program along with that from the rest of the farm.





# REFERENCES

## OVERVIEW

A selection of documents has been reviewed in preparing this Practice Note covering consenting, investigations, design, construction and operation of Dairy Farm Infrastructure.

This section provides a brief summary and links to relevant documents available.

## PART 1: LEGISLATION

### NEW ZEALAND LEGISLATION

A GLOSSARY OF TERMS USED IN NEW ZEALAND LEGISLATION

[www.legislation.govt.nz/glossary.aspx](http://www.legislation.govt.nz/glossary.aspx)

ANIMAL PRODUCTS ACT 1999

[www.legislation.govt.nz/act/public/1999/0093/latest/DLM33502.html](http://www.legislation.govt.nz/act/public/1999/0093/latest/DLM33502.html)

ANIMAL WELFARE ACT 1999

[www.legislation.govt.nz/act/public/1999/0142/latest/DLM49664.html](http://www.legislation.govt.nz/act/public/1999/0142/latest/DLM49664.html)

HEALTH AND SAFETY AT WORK ACT 2015 NO 70

[www.legislation.govt.nz/act/public/2015/0070/latest/DLM5976660.html](http://www.legislation.govt.nz/act/public/2015/0070/latest/DLM5976660.html)

RESOURCE MANAGEMENT ACT 1991 NO 69

[www.legislation.govt.nz/act/public/1991/0069/latest/DLM230265.html](http://www.legislation.govt.nz/act/public/1991/0069/latest/DLM230265.html)

BUILDING ACT 2004 NO 72

[www.legislation.govt.nz/act/public/2004/0072/latest/DLM306036.html](http://www.legislation.govt.nz/act/public/2004/0072/latest/DLM306036.html)

BUILDING REGULATIONS (THE BUILDING CODE)

[www.legislation.govt.nz/regulation/public/1992/0150/latest/whole.html#DLM162576](http://www.legislation.govt.nz/regulation/public/1992/0150/latest/whole.html#DLM162576)

### DAIRYNZ

HEALTH AND SAFETY

[www.dairynz.co.nz/people/compliance/health-and-safety-in-detail](http://www.dairynz.co.nz/people/compliance/health-and-safety-in-detail)

## **MINISTRY OF BUSINESS, INNOVATION AND EMPLOYMENT**

G14 INDUSTRIAL LIQUID WASTE

[www.building.govt.nz/building-code-compliance/g-services-and-facilities/g14-industrial-liquid-waste](http://www.building.govt.nz/building-code-compliance/g-services-and-facilities/g14-industrial-liquid-waste)

BUILDING CODE, HANDBOOK

[www.building.govt.nz/building-code-compliance/building-code-and-handbooks/building-code-handbook](http://www.building.govt.nz/building-code-compliance/building-code-and-handbooks/building-code-handbook)

### **BUILDING CODE**

Find acceptable solutions, verification methods, updates and technical guidance by Building Code clause

[www.building.govt.nz/#building-code](http://www.building.govt.nz/#building-code)

A BEGINNER'S GUIDE TO RESOURCE AND BUILDING CONSENT PROCESSES

– UNDER THE RESOURCE MANAGEMENT ACT 1991 AND THE BUILDING ACT 2004

[www.dbh.govt.nz/rma-guide-index#aid6](http://www.dbh.govt.nz/rma-guide-index#aid6)

## **MINISTRY FOR THE ENVIRONMENT**

ABOUT CONTAMINATED LAND IN NEW ZEALAND

[www.mfe.govt.nz/land/about-contaminated-land-new-zealand](http://www.mfe.govt.nz/land/about-contaminated-land-new-zealand)

HAZARDOUS ACTIVITIES AND INDUSTRIES LIST (HAIL)

[www.mfe.govt.nz/land/hazardous-activities-and-industries-list-hail](http://www.mfe.govt.nz/land/hazardous-activities-and-industries-list-hail)

## **MINISTRY FOR PRIMARY INDUSTRIES**

NZCP1: DESIGN AND OPERATION OF FARM DAIRIES, 19 MAY 2017

[www.foodsafety.govt.nz/elibrary/industry/dairy-nzcp1-design-code-of-practice/amdt-2.pdf](http://www.foodsafety.govt.nz/elibrary/industry/dairy-nzcp1-design-code-of-practice/amdt-2.pdf)

DAIRY CATTLE CODE OF WELFARE, 13 JUNE 2014

[www.mpi.govt.nz/protection-and-response/animal-welfare/codes-of-welfare](http://www.mpi.govt.nz/protection-and-response/animal-welfare/codes-of-welfare)

[www.dairynz.co.nz/publications/animal/dairy-cattle-code-of-welfare-2014](http://www.dairynz.co.nz/publications/animal/dairy-cattle-code-of-welfare-2014)

## **STANDARDS AUSTRALIA**

Australian standards can be purchased (or sourced if subscribed) through the Standards Australia website

[www.standards.org.au/SearchandBuyAStandard/Pages/default.aspx](http://www.standards.org.au/SearchandBuyAStandard/Pages/default.aspx)

AS 1657: Fixed platforms, walkways, stairways and ladders. Design, construction and installation

## **WORKSAFE NEW ZEALAND**

### **WORKING AT HEIGHT IN NEW ZEALAND**

[construction.worksafe.govt.nz/guides/working-at-height-in-new-zealand](https://www.construction.worksafe.govt.nz/guides/working-at-height-in-new-zealand)

### **HEALTH AND SAFETY AT WORK**

[www.worksafe.govt.nz/worksafe/information-guidance/all-guidance-items/hswa-quick-reference-guide/HSWA-quick-reference-guide-december2016.pdf](https://www.worksafe.govt.nz/worksafe/information-guidance/all-guidance-items/hswa-quick-reference-guide/HSWA-quick-reference-guide-december2016.pdf)

### **CONSTRUCTION GUIDES**

[construction.worksafe.govt.nz/guides](https://www.construction.worksafe.govt.nz/guides)

### **SAFER FARMS**

[www.saferfarms.org.nz/guides](https://www.saferfarms.org.nz/guides)

## **PART 2: SOLIDS SEPARATION**

### **DAIRYNZ**

#### **DAIRYNZ EFFLUENT RESOURCES**

[www.dairynz.co.nz/publications/environment/catalogue-of-effluent-resources](http://www.dairynz.co.nz/publications/environment/catalogue-of-effluent-resources)

#### **EFFLUENT SYSTEMS**

[www.dairynz.co.nz/environment/effluent](http://www.dairynz.co.nz/environment/effluent)

#### **EFFLUENT STORAGE**

[www.dairynz.co.nz/environment/effluent/effluent-storage](http://www.dairynz.co.nz/environment/effluent/effluent-storage)

#### **DESIGNING OR UPGRADING EFFLUENT SYSTEMS**

[www.dairynz.co.nz/environment/effluent/designing-or-upgrading-effluent-systems](http://www.dairynz.co.nz/environment/effluent/designing-or-upgrading-effluent-systems)

### **DAIRYNZ FARMFACTS**

#### **EFFLUENT OXIDATION POND TREATMENT SYSTEMS**

(6-1) “How effluent oxidation ponds work”

[www.dairynz.co.nz/publications/farmfacts/effluent-management/farmfact-6-1](http://www.dairynz.co.nz/publications/farmfacts/effluent-management/farmfact-6-1)

(6-3) “Improving effluent pond treatment systems”

[www.dairynz.co.nz/publications/farmfacts/effluent-management/farmfact-6-3](http://www.dairynz.co.nz/publications/farmfacts/effluent-management/farmfact-6-3)

### **EFFLUENT SOLIDS**

(6-25), “EFFLUENT STONE TRAPS”

[www.dairynz.co.nz/publications/farmfacts/effluent-management/farmfact-6-25](http://www.dairynz.co.nz/publications/farmfacts/effluent-management/farmfact-6-25)

(6-26), “PASSIVE SYSTEMS FOR EFFLUENT SOLIDS SEPARATION”

[www.dairynz.co.nz/publications/farmfacts/effluent-management/farmfact-6-26](http://www.dairynz.co.nz/publications/farmfacts/effluent-management/farmfact-6-26)

(6-27), “EFFLUENT SOLIDS SEPARATION USING A MECHANICAL SYSTEM”

[www.dairynz.co.nz/publications/farmfacts/effluent-management/farmfact-6-27](http://www.dairynz.co.nz/publications/farmfacts/effluent-management/farmfact-6-27)

(6-28), “EFFLUENT SLURRIES, SLUDGE, AND SOLIDS SPREADING”

[www.dairynz.co.nz/publications/farmfacts/effluent-management/farmfact-6-28](http://www.dairynz.co.nz/publications/farmfacts/effluent-management/farmfact-6-28)

### **DAIRY AUSTRALIA**

#### **EFFLUENT AND MANURE MANAGEMENT DATABASE FOR THE AUSTRALIAN DAIRY INDUSTRY**

[www.dairyingfortomorrow.com.au/tools-and-guidelines/effluent-and-manure-management-database-for-the-australian-dairy-industry](http://www.dairyingfortomorrow.com.au/tools-and-guidelines/effluent-and-manure-management-database-for-the-australian-dairy-industry)

## **PART 3: UNDERPASSES**

### **DAIRYNZ**

#### **FARMAFACTS: 8.0 FARM INFRASTRUCTURE**

Tracks and races (8-1)

Road underpasses (8-7)

Building culverts and bridges (8-8)

[www.dairynz.co.nz/publications/farmfacts/farm-infrastructure](http://www.dairynz.co.nz/publications/farmfacts/farm-infrastructure)

#### **EFFICIENT TRACKS**

[www.dairynz.co.nz/milking/track-and-yard/efficient-tracks](http://www.dairynz.co.nz/milking/track-and-yard/efficient-tracks)

#### **PLANNING THE RIGHT SYSTEM FOR YOUR FARM**

[www.dairynz.co.nz/publications/environment/farm-dairy-effluent-fde-systems-planning-the-right-system-for-your-farm](http://www.dairynz.co.nz/publications/environment/farm-dairy-effluent-fde-systems-planning-the-right-system-for-your-farm)

#### **A FARMER'S GUIDE TO BUILDING A NEW EFFLUENT STORAGE POND**

[www.dairynz.co.nz/publications/environment/a-farmers-guide-to-building-a-new-effluent-storage-pond](http://www.dairynz.co.nz/publications/environment/a-farmers-guide-to-building-a-new-effluent-storage-pond)

### **NZ TRANSPORT AGENCY (NZTA)**

#### **BRIDGE MANUAL (THIRD EDITION)**

[www.nzta.govt.nz/resources/bridge-manual/bridge-manual.html](http://www.nzta.govt.nz/resources/bridge-manual/bridge-manual.html)

#### **CODE OF PRACTICE FOR TEMPORARY TRAFFIC MANAGEMENT (COPTTM)**

[www.nzta.govt.nz/resources/code-temp-traffic-management/copttm.html](http://www.nzta.govt.nz/resources/code-temp-traffic-management/copttm.html)

#### **MANUAL OF TRAFFIC SIGNS AND MARKINGS (MOTSAM)**

[www.nzta.govt.nz/resources/motsam/part-1](http://www.nzta.govt.nz/resources/motsam/part-1)

#### **ROAD SAFETY BARRIER SYSTEMS**

[www.nzta.govt.nz/resources/road-safety-barrier-systems/?category=&subcategory=&audience=&term=M23](http://www.nzta.govt.nz/resources/road-safety-barrier-systems/?category=&subcategory=&audience=&term=M23)

### **NEW ZEALAND UTILITIES ADVISORY GROUP**

#### **NATIONAL CODE OF PRACTICE FOR UTILITY OPERATORS' ACCESS TO TRANSPORT CORRIDORS**

[nzuag.org.nz/national-code](http://nzuag.org.nz/national-code)

### **ROAD CONTROLLING AUTHORITIES FORUM (NZ) LTD**

#### **BEST PRACTICE GUIDELINES FOR STOCK CROSSINGS**

[rcaforum.org.nz/working-groups/stock-crossings/guidelines-for-stock-crossings](http://rcaforum.org.nz/working-groups/stock-crossings/guidelines-for-stock-crossings)

### **STANDARDS NEW ZEALAND**

#### **AS/NZS 2041 BURIED CORRUGATED METAL STRUCTURES**

## **PART 4: CONCRETE STRUCTURES**

### **CEMENT AND CONCRETE ASSOCIATION OF NEW ZEALAND (CCANZ)**

Specific publications directly relevant to concrete for Farm Dairy Infrastructure include:

#### **IB 08: REPAIRS TO CONCRETE**

[www.ccanz.org.nz/files/documents/be924258-51d5-493c-90a5-aed671f3a3e7/IB%2008%20-%20Repairs%20to%20Concrete.pdf](http://www.ccanz.org.nz/files/documents/be924258-51d5-493c-90a5-aed671f3a3e7/IB%2008%20-%20Repairs%20to%20Concrete.pdf)

#### **IB 39: FIBRE REINFORCED CONCRETE**

[www.ccanz.org.nz/files/documents/25b2b58c-9f42-4ebd-a485-71028bbe4c2a/IB%2039%20-%20Fibre%20Reinforced%20Concrete.pdf](http://www.ccanz.org.nz/files/documents/25b2b58c-9f42-4ebd-a485-71028bbe4c2a/IB%2039%20-%20Fibre%20Reinforced%20Concrete.pdf)

#### **IB 55: CONCRETE FOR THE FARM**

[www.ccanz.org.nz/files/documents/b85c0be8-4746-4438-93f6-a6275575178f/IB%2055%20-%20Concrete%20for%20the%20Farm%20\(2012\).pdf](http://www.ccanz.org.nz/files/documents/b85c0be8-4746-4438-93f6-a6275575178f/IB%2055%20-%20Concrete%20for%20the%20Farm%20(2012).pdf)

#### **IB 73: CRACKING**

[www.ccanz.org.nz/files/documents/47e57760-da98-493e-8fc0-0e50318a6f29/IB%2073%20-%20Cracking.pdf](http://www.ccanz.org.nz/files/documents/47e57760-da98-493e-8fc0-0e50318a6f29/IB%2073%20-%20Cracking.pdf)

#### **IB 75: ABRASION RESISTANCE**

[www.ccanz.org.nz/files/documents/772774ee-d7e6-4f40-baa1-16f278abb5f1/IB%2075%20-%20Abrasion%20Resistance.pdf](http://www.ccanz.org.nz/files/documents/772774ee-d7e6-4f40-baa1-16f278abb5f1/IB%2075%20-%20Abrasion%20Resistance.pdf)

#### **IB 84: HEALTH AND SAFETY**

[www.ccanz.org.nz/files/documents/6c43daf8-d3db-4094-a2b8-53a52216c920/IB%2084%20-%20Health%20and%20Safety.pdf](http://www.ccanz.org.nz/files/documents/6c43daf8-d3db-4094-a2b8-53a52216c920/IB%2084%20-%20Health%20and%20Safety.pdf)

#### **IB 86: SELF-COMPACTING CONCRETE**

[www.ccanz.org.nz/files/documents/95a5a560-c9ee-40d7-8f75-6a47658acca4/IB%2086%20-%20Self%20Compacting%20Concrete.pdf](http://www.ccanz.org.nz/files/documents/95a5a560-c9ee-40d7-8f75-6a47658acca4/IB%2086%20-%20Self%20Compacting%20Concrete.pdf)

CCANZ HAS A RANGE OF PUBLICATIONS WHICH CAN ALL BE VIEWED THROUGH THEIR WEBSITE AT:

[www.ccanz.org.nz/documents.aspx](http://www.ccanz.org.nz/documents.aspx)

### **NEW ZEALAND CONCRETE MASONRY ASSOCIATION (NZCMA)**

NZ STANDARDS RELEVANT TO THE CONCRETE MASONRY INDUSTRY

[www.nzcma.org.nz/standards.html](http://www.nzcma.org.nz/standards.html)

MASONRY MANUAL

[www.nzcma.org.nz/masonry-manual.aspx](http://www.nzcma.org.nz/masonry-manual.aspx)

### **NZ TRANSPORT AGENCY (NZTA)**

BRIDGE MANUAL

[www.nzta.govt.nz/resources/bridge-manual/bridge-manual.html](http://www.nzta.govt.nz/resources/bridge-manual/bridge-manual.html)

## **STANDARDS NEW ZEALAND**

NZ standards can be purchased (or sourced if subscribed) through the Standards New Zealand website

[www.standards.govt.nz/search-and-buy-standards/searching-for-standards](http://www.standards.govt.nz/search-and-buy-standards/searching-for-standards)

AS/NZS 1170, Parts 0–5: Structural Design Actions

NZS 3101: Concrete Structures Standard

NZS 3104: Specification for the Production of Concrete

NZS 3106: Design of Concrete Structures for the Storage of Liquids

NZS 3109: Concrete Construction

NZS 4210:2001 Masonry Construction: Materials and Workmanship

NZS 4229:2013 Concrete Masonry Buildings Not Requiring Specific Design

NZS 4230:2004 Design of Reinforced Concrete Masonry Structures

AS/NZS 4455:2008–10, Parts 1–3, Masonry Units, Pavers, Flags and Segmental Retaining Wall Units

## **PART 5: FEED PADS**

### **CEMENT AND CONCRETE ASSOCIATION OF NEW ZEALAND (CCANZ)**

Specific publications directly relevant to concrete feed pads include:

#### **IB 39: FIBRE REINFORCED CONCRETE**

[www.ccanz.org.nz/files/documents/25b2b58c-9f42-4ebd-a485-71028bbe4c2a/IB%2039%20-%20Fibre%20Reinforced%20Concrete.pdf](http://www.ccanz.org.nz/files/documents/25b2b58c-9f42-4ebd-a485-71028bbe4c2a/IB%2039%20-%20Fibre%20Reinforced%20Concrete.pdf)

#### **IB 55: CONCRETE FOR THE FARM**

[www.ccanz.org.nz/files/documents/b85c0be8-4746-4438-93f6-a6275575178f/IB%2055%20-%20Concrete%20for%20the%20Farm%20\(2012\).pdf](http://www.ccanz.org.nz/files/documents/b85c0be8-4746-4438-93f6-a6275575178f/IB%2055%20-%20Concrete%20for%20the%20Farm%20(2012).pdf)

### **DAIRYNZ**

#### **DESIGNING SILAGE AND FEED STORAGE AREAS (1-48)**

[www.dairynz.co.nz/publications/farmfacts/farm-management/farmfact-1-48](http://www.dairynz.co.nz/publications/farmfacts/farm-management/farmfact-1-48)

#### **FACTS AND FIGURES FOR NEW ZEALAND DAIRY FARMERS**

[www.dairynz.co.nz/publications/dairy-industry/facts-and-figures](http://www.dairynz.co.nz/publications/dairy-industry/facts-and-figures)

#### **FARMAFACTS: 8.0 FARM INFRASTRUCTURE**

Tracks and races (8-1)

Feed pads – design and construction (8-2)

Feed pads – management and maintenance (8-3)

Stand-off pads – design and construction (8-4)

Stand-off pads: proactive management and maintenance (8-5)

Covered pads and barns (8-6)

[www.dairynz.co.nz/publications/farmfacts/farm-infrastructure](http://www.dairynz.co.nz/publications/farmfacts/farm-infrastructure)

#### **PLANNING THE RIGHT SYSTEM FOR YOUR FARM**

[www.dairynz.co.nz/publications/environment/farm-dairy-effluent-fde-systems-planning-the-right-system-for-your-farm](http://www.dairynz.co.nz/publications/environment/farm-dairy-effluent-fde-systems-planning-the-right-system-for-your-farm)

### **DAIRY AUSTRALIA**

#### **EFFLUENT AND MANURE MANAGEMENT DATABASE FOR THE AUSTRALIAN DAIRY INDUSTRY**

Chapter 4.2 Feed pads, calving pads and loafing pads

[www.dairyingfortomorrow.com.au/wp-content/uploads/feedpads.pdf](http://www.dairyingfortomorrow.com.au/wp-content/uploads/feedpads.pdf)

### **MASSEY UNIVERSITY**

#### **FERTILIZER AND LIME RESEARCH CENTRE**

Dairy Effluent Storage Calculator (Download and installation instructions)

[www.massey.ac.nz/~flrc/required/FDE%20Calculator/Obtain\\_DESC.html](http://www.massey.ac.nz/~flrc/required/FDE%20Calculator/Obtain_DESC.html)



# DISCLAIMER

DairyNZ Limited (“DairyNZ”, “we”, “our”) and the Institution of Professional Engineers New Zealand (IPENZ), collectively “we”, endeavour to ensure the information in this Practice Note is accurate and current. However, we do not accept liability for any error or omission, nor can we be held responsible for its accuracy, currency, or fitness for purpose as best practice is subject to change without notice.

The information in this Practice Note is intended to provide the best possible advice DairyNZ and IPENZ have access to. It is important to note the information is provided as general guidance only and is not intended as a substitute for specific advice. While every care is taken in their preparation, these documents are not offered as formal advice and practitioners must exercise their own professional skill and judgement in applying them. Practices, systems, and advice may vary depending on the individual circumstances. The information may also be subject to change at any time without notice. DairyNZ and IPENZ take no responsibility whatsoever for the currency and/or accuracy of this information, its completeness, or fitness for purpose.

# COPYRIGHT

Copyright in this publication (including text and graphics) is owned or licensed to DairyNZ.

Other than for the purposes of, and subject to the conditions prescribed under, the Copyright Act 1994 and similar legislation which applies in your location, and except as expressly authorised by these terms and conditions, you may not in any form or by any means adapt, reproduce, store, distribute, print, display, perform, publish, or create derivative works from any part of this publication or commercialise any information, products, or services obtained from any part of this publication without our written permission.



To facilitate the delivery of this Practice Note, DairyNZ as sponsor have engaged Opus International Consultants Ltd as the lead consultant.

## **EDITOR/LEAD AUTHOR**

**Rex Corlett FIPENZ, CPEng**  
Principal Engineer – Rural  
Opus International Consultants  
Christchurch, New Zealand  
[Rex.Corlett@opus.co.nz](mailto:Rex.Corlett@opus.co.nz)

© DairyNZ 2017





## **Version History**

Version 2 – August 2017

The Institution of Professional Engineers New Zealand Inc  
*Pūtahi Kaiwetepanga Ngaio o Aotearoa*

PO Box 12 241  
Wellington 6144  
New Zealand

P +64 4 473 9444  
E [ipenz@ipenz.org.nz](mailto:ipenz@ipenz.org.nz)  
   EngineersNZ